

## PART 1 - GENERAL (GEN)

### GEN 0.

#### GEN 0.1 PREFACE

##### 0.1.1. Name of the publishing authority

The Republic of Cabo Verde AIP is published by ASA - Aeroportos e Seguranca Aerea - S.A. on behalf of the Republic of Cabo Verde.

##### 0.1.2. Applicable ICAO documents

The AIP is prepared in accordance with the Standards and Recommended Practices (SARP) of Annex 15 to the Convention on International Civil Aviation, the *Aeronautical Information Services Manual* (ICAO Doc 8126) and the *Aeronautical Information Management Manual* (ICAO Doc 10066). Charts contained in the AIP are produced in accordance with Annex 4 to the Convention on International Civil Aviation and the *Aeronautical Chart Manual* (Doc 8697). Differences from ICAO Standards, Recommended Practices and Procedures are given in subsection GEN 1.7.

##### 0.1.3. Publication media

The Republic of Cabo Verde AIP, AIP Amendments, AIP Supplements and Information Circulars (AIC) are published in electronic form on the internet.

##### 0.1.4. AIP structure and established regular amendment interval

###### 0.1.4.1 AIP structure

The AIP forms part of the Aeronautical Information Products, details of which are given in subsection **GEN 3.1**. The principal AIP structure is shown in graphic form on page **GEN 0.1-3**.

The AIP is made up of three Parts, General (GEN), Enroute (ENR) and Aerodromes (AD), each divided into sections and subsections as applicable, containing various types of information subjects.

###### 0.1.4.1.1 Part 1 - General (GEN)

Part 1 consists of five sections containing information as briefly described hereafter.

- a) *GEN 0.* - Preface; Record of AIP Amendments; Record of AIP Supplements; Checklist of AIP pages; List of hand amendments to the AIP; and the Table of Contents to Part 1.
- b) *GEN 1. National regulations and requirements* - Designated authorities; Entry, transit and departure of aircraft; Entry, transit and departure of passengers and crew; Entry, transit and departure of cargo; Aircraft instruments, equipment and flight documents; Summary of national regulations and international agreements/conventions; and Differences from ICAO Standards, Recommended Practices and Procedures.
- c) *GEN 2. Tables and codes* - Measuring system; Aircraft markings; Holidays; Abbreviations used in AIS products; Chart symbols; Location indicators; List of radio navigation aids; Conversion tables; and Sunrise/Sunset tables.
- d) *GEN 3. Services* - Aeronautical information services; Aeronautical charts; Air traffic services; Communication services; Meteorological services; and Search and rescue.
- e) *GEN 4. Charges for aerodromes/heliports and air navigation services* - Aerodrome/heliport charges; and Air navigation services charges.

###### 0.1.4.1.2 Part 2 - Enroute (ENR)

Part 2 consists of seven sections containing information as briefly described hereafter.

- a) *ENR 0.* - Preface; Record of AIP Amendments; Record of AIP Supplements; Checklist of AIP pages; List of hand amendments to the AIP; and the Table of Contents to Part 2.
- b) *ENR 1. General rules and procedures* - General rules; Visual flight rules; Instrument flight rules; ATS airspace classification; Holding, approach and departure procedures; Radar services and procedures; Altimeter setting procedures; Regional supplementary procedures; Air traffic flow management; Flight planning; Addressing of flight plan messages; Interception of civil aircraft; Unlawful interference; and Air traffic incidents.
- c) *ENR 2. Air traffic services airspace* - Detailed description of Flight information regions (FIR); Upper flight information regions (UIR); Terminal control areas (TMA); Control areas (CTA) and Other regulated airspace.
- d) *ENR 3. ATS routes* - Detailed description of Conventional ATS routes; Area navigation routes; Other routes; and Enroute holding.

**Note:** Other types of routes which are specified in connection with procedures for traffic to and from aerodromes/heliports are described in the relevant sections and subsections of Part 3 - Aerodromes.

- e) *ENR 4. Radio navigation aids/systems* - Radio navigation aids - enroute; Special navigation systems; Name-code designators for significant points; and Aeronautical ground lights - enroute.
- f) *ENR 5. Navigation warnings* - Prohibited, restricted and danger areas; Military exercise and training areas and air defence identification zone (ADIZ); Other activities of a dangerous nature and other potential hazards; Air navigation obstacles - enroute; Aerial sporting and recreational activities; and Bird migration and areas with sensitive fauna.
- g) *ENR 6. Enroute charts* - Enroute Chart - ICAO and index charts.

###### 0.1.4.1.3 Part 3 - Aerodromes (AD)

Part 3 consists of four sections containing information as briefly described hereafter.

- a) *AD 0.* - Preface; Record of AIP Amendments; Record of AIP Supplements; Checklist of AIP pages; List of hand amendments to the AIP; and the Table of Contents to Part 3.
- b) *AD 1. Aerodromes/Heliports - Introduction* - Aerodrome/heliport availability; Rescue and fire fighting services and Snow plan; Index to aerodromes and heliports; and Grouping of aerodromes/heliports.
- c) *AD 2. Aerodromes* - Detailed information about aerodromes, including helicopter landing areas, if located at the aerodromes, listed under 24 subsections.
- d) *AD 3. Heliports* - Detailed information about heliports (not located at aerodromes), listed under 23 subsections.

###### 0.1.4.2 Regular amendment interval

Regular amendments to the AIP will be issued once every three months. The publication dates will be on the first day of February, May, August and November of each year.

##### 0.1.5. Copyright policy

Redistribution and copying of the contents of this publication only by prior agreement with ASA - Aeroportos e Seguranca Aerea - S.A..

**0.1.6. Service to contact in case of detected AIP errors or omissions**

In the compilation of the AIP, care has been taken to ensure that the information contained therein is accurate and complete. Any errors and omissions which may nevertheless be detected, as well as any correspondence concerning the Aeronautical Information Products, should be referred to:

Air Navigation Direction (DNA)

Aeronautical Information Management Service (SGIA) - AIS / MAP

Aeroporto Amílcar Cabral  
Espargos  
Sal Island  
Republic Of Cabo Verde  
TEL: +238 2412502  
Telefax: +238 2413264  
e-mail: [sgia@asa.cv](mailto:sgia@asa.cv)  
AFS: GVACYOYX  
Http: NIL

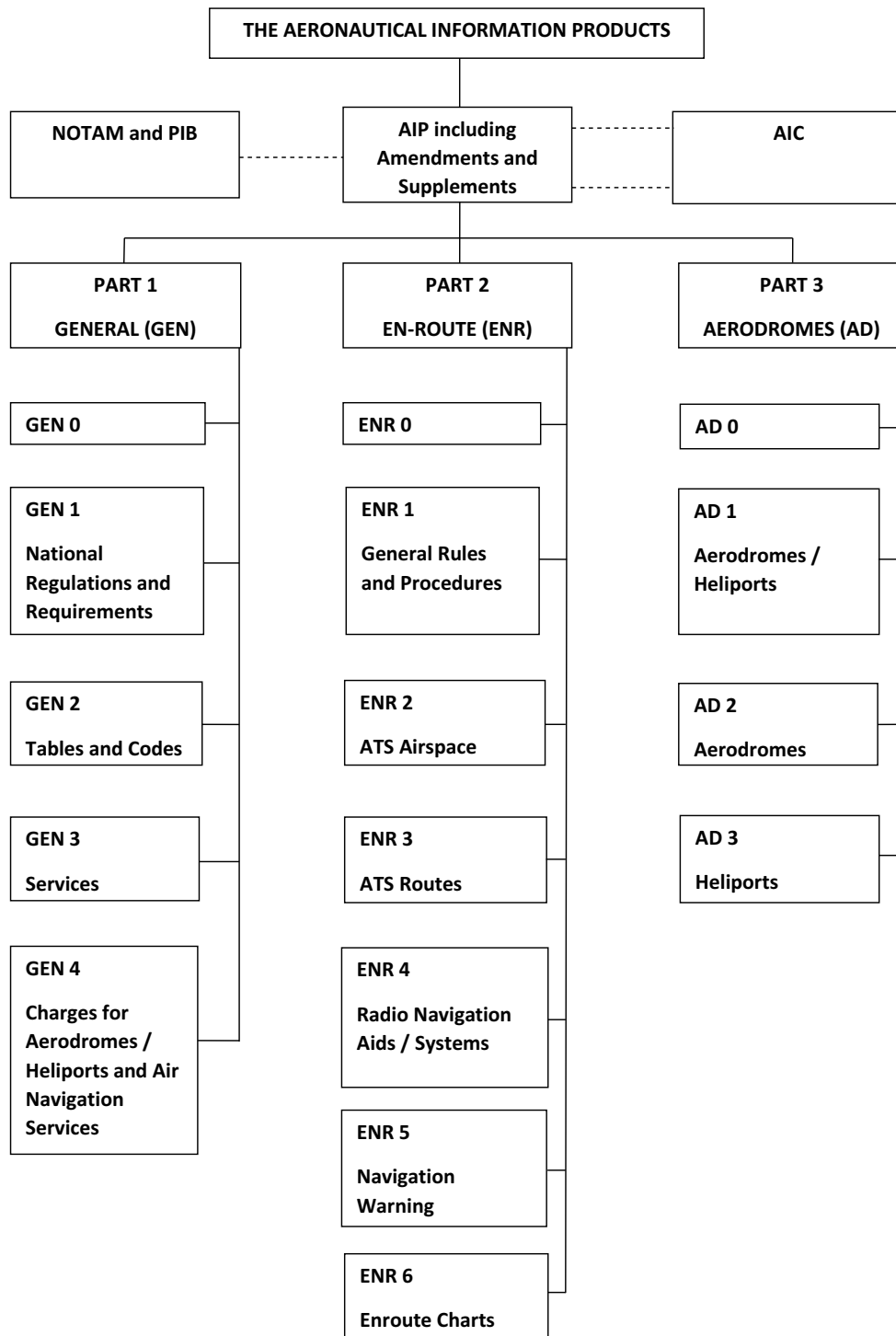

**INTENTIONALLY LEFT BLANK**



**INTENTIONALLY LEFT BLANK**



**INTENTIONALLY LEFT BLANK**



**GEN 0.4 CHECKLIST OF AIP PAGES**

<i>Page</i>	<i>Date</i>	<i>Page</i>	<i>Date</i>
<b>PART 1 - GENERAL (GEN)</b>		3.6-1	19 MAY 2022
<b>GEN 0.</b>		3.6-2	19 MAY 2022
0.1-1	19 MAY 2022	<b>GEN 4.</b>	
0.1-2	19 MAY 2022	4.1-1	19 MAY 2022
0.1-3	19 MAY 2022	4.1-2	19 MAY 2022
0.1-1	19 MAY 2022	4.1-3	19 MAY 2022
0.3-1	19 MAY 2022	4.2-1	19 MAY 2022
0.4-1	19 MAY 2022		
0.4-2	19 MAY 2022	<b>PART 2 - EN-ROUTE (ENR)</b>	
0.4-3	19 MAY 2022	<b>ENR 0.</b>	
0.5-1	19 MAY 2022	0.1-1	19 MAY 2022
0.6-1	19 MAY 2022	<b>ENR 1.</b>	
<b>GEN 1.</b>		1.1-1	19 MAY 2022
1.1-1	19 MAY 2022	1.1-2	19 MAY 2022
1.2-1	19 MAY 2022	1.2-1	19 MAY 2022
1.2-2	19 MAY 2022	1.2-2	19 MAY 2022
1.2-3	19 MAY 2022	1.3-1	19 MAY 2022
1.2-4	19 MAY 2022	1.3-2	19 MAY 2022
1.2-5	19 MAY 2022	1.4-1	19 MAY 2022
1.3-1	19 MAY 2022	1.4-2	19 MAY 2022
1.4-1	19 MAY 2022	1.4-3	19 MAY 2022
1.5-1	19 MAY 2022	1.5-1	19 MAY 2022
1.6-1	19 MAY 2022	1.6-1	19 MAY 2022
1.6-2	19 MAY 2022	1.6-2	19 MAY 2022
1.7-1	19 MAY 2022	1.7-1	19 MAY 2022
<b>GEN 2.</b>		1.7-2	19 MAY 2022
2.1-1	19 MAY 2022	1.8-1	19 MAY 2022
2.1-2	19 MAY 2022	1.8-2	19 MAY 2022
2.2-1	19 MAY 2022	1.9-1	19 MAY 2022
2.2-2	19 MAY 2022	1.9-2	19 MAY 2022
2.2-3	19 MAY 2022	1.10-1	19 MAY 2022
2.2-4	19 MAY 2022	1.10-2	19 MAY 2022
2.2-5	19 MAY 2022	1.10-3	19 MAY 2022
2.2-6	19 MAY 2022	1.10-4	19 MAY 2022
2.2-7	19 MAY 2022	1.11-1	19 MAY 2022
2.2-8	19 MAY 2022	1.12-1	19 MAY 2022
2.2-9	19 MAY 2022	1.12-2	19 MAY 2022
2.2-10	19 MAY 2022	1.13-1	19 MAY 2022
2.3-1	19 MAY 2022	1.14-1	19 MAY 2022
2.3-2	19 MAY 2022	1.14-2	19 MAY 2022
2.3-3	19 MAY 2022	1.14-3	19 MAY 2022
2.3-4	19 MAY 2022	1.14-4	19 MAY 2022
2.3-5	19 MAY 2022	1.14-5	19 MAY 2022
2.4-1	19 MAY 2022	1.14-6	19 MAY 2022
2.5-1	19 MAY 2022	<b>ENR 2.</b>	
2.6-1	19 MAY 2022	2.1-1	19 MAY 2022
2.6-2	19 MAY 2022	2.1-2	19 MAY 2022
2.7-1	19 MAY 2022	2.1-3	19 MAY 2022
<b>GEN 3.</b>		2.1-4	19 MAY 2022
3.1-1	19 MAY 2022	2.1-5	19 MAY 2022
3.1-2	19 MAY 2022	2.2-1	19 MAY 2022
3.1-3	19 MAY 2022	<b>ENR 3.</b>	
3.1-4	19 MAY 2022	3.1-1	19 MAY 2022
3.2-1	19 MAY 2022	3.1-2	19 MAY 2022
3.2-2	19 MAY 2022	3.1-3	19 MAY 2022
3.3-1	19 MAY 2022	3.1-4	19 MAY 2022
3.3-2	19 MAY 2022	3.1-5	19 MAY 2022
3.4-1	19 MAY 2022	3.1-6	19 MAY 2022
3.4-2	19 MAY 2022	3.1-7	19 MAY 2022
3.4-3	19 MAY 2022	3.1-8	19 MAY 2022
3.5-1	19 MAY 2022	3.1-9	19 MAY 2022
3.5-2	19 MAY 2022	3.1-10	19 MAY 2022
3.5-3	19 MAY 2022	3.1-11	19 MAY 2022
3.5-4	19 MAY 2022	3.1-12	19 MAY 2022
3.5-5	19 MAY 2022		

<i>Page</i>	<i>Date</i>	<i>Page</i>	<i>Date</i>
3.1-13	19 MAY 2022	AD 2-8	19 MAY 2022
3.1-14	19 MAY 2022	AD 2-9	19 MAY 2022
3.1-15	19 MAY 2022	AD 2-10	19 MAY 2022
3.1-16	19 MAY 2022	AD 2-11	19 MAY 2022
3.1-17	19 MAY 2022	AD 2-12	19 MAY 2022
3.1-18	19 MAY 2022	AD 2-13	19 MAY 2022
3.1-19	19 MAY 2022	AD 2-14	19 MAY 2022
3.1-20	19 MAY 2022	AD 2-15	19 MAY 2022
3.1-21	19 MAY 2022	AD 2-16	19 MAY 2022
3.1-22	19 MAY 2022	AD 2-17	19 MAY 2022
3.2-1	19 MAY 2022	AD 2-18	19 MAY 2022
3.2-2	19 MAY 2022	AD 2-19	19 MAY 2022
3.2-3	19 MAY 2022	AD 2-20	19 MAY 2022
3.2-4	19 MAY 2022	AD 2-21	19 MAY 2022
3.2-5	19 MAY 2022	AD 2-22	19 MAY 2022
3.2-6	19 MAY 2022		
3.2-7	19 MAY 2022		
3.3-1	19 MAY 2022	<b>RABIL / ARISTIDES PEREIRA</b>	
3.3-2	19 MAY 2022	AD 2-1	19 MAY 2022
3.3-3	19 MAY 2022	AD 2-2	19 MAY 2022
3.3-4	19 MAY 2022	AD 2-3	19 MAY 2022
3.4-1	19 MAY 2022	AD 2-4	19 MAY 2022
3.5-1	19 MAY 2022	AD 2-5	19 MAY 2022
3.6-1	19 MAY 2022	AD 2-6	19 MAY 2022
		AD 2-7	19 MAY 2022
		AD 2-8	19 MAY 2022
<b>ENR 4.</b>		AD 2-9	19 MAY 2022
4.1-1	19 MAY 2022	AD 2-10	19 MAY 2022
4.2-1	19 MAY 2022	AD 2-11	19 MAY 2022
4.3-1	19 MAY 2022	AD 2-12	19 MAY 2022
4.4-1	19 MAY 2022	AD 2-13	19 MAY 2022
4.4-2	19 MAY 2022	AD 2-14	19 MAY 2022
4.5-1	19 MAY 2022	AD 2-15	19 MAY 2022
		AD 2-16	19 MAY 2022
<b>ENR 5.</b>		AD 2-17	19 MAY 2022
5.1-1	19 MAY 2022	AD 2-18	19 MAY 2022
5.2-1	19 MAY 2022	AD 2-19	19 MAY 2022
5.3-1	19 MAY 2022	AD 2-20	19 MAY 2022
5.4-1	19 MAY 2022	AD 2-21	19 MAY 2022
5.5-1	19 MAY 2022	AD 2-22	19 MAY 2022
5.6-1	19 MAY 2022	AD 2-23	19 MAY 2022
		AD 2-24	19 MAY 2022
		AD 2-25	19 MAY 2022
<b>ENR 6.</b>		AD 2-26	19 MAY 2022
6-1	19 MAY 2022	AD 2-27	19 MAY 2022
6-2	19 MAY 2022	AD 2-28	19 MAY 2022
6-3	19 MAY 2022	AD 2-29	19 MAY 2022
		AD 2-30	19 MAY 2022
<b>PART 3 - AERODROMES (AD)</b>		AD 2-31	19 MAY 2022
<b>AD 0.</b>		AD 2-32	19 MAY 2022
0.1-1	19 MAY 2022		
0.1-2	19 MAY 2022		
0.1-3	19 MAY 2022	<b>MAIO ISLAND / MAIO</b>	
		AD 2-1	19 MAY 2022
<b>AD 1.</b>		AD 2-2	19 MAY 2022
1.1-1	19 MAY 2022	AD 2-3	19 MAY 2022
1.1-2	19 MAY 2022	AD 2-4	19 MAY 2022
1.2-1	19 MAY 2022	AD 2-5	19 MAY 2022
1.3-1	19 MAY 2022	AD 2-6	19 MAY 2022
1.3-2	19 MAY 2022	AD 2-7	19 MAY 2022
1.4-1	19 MAY 2022	AD 2-8	19 MAY 2022
1.5-1	19 MAY 2022		
		<b>PRAIA / NELSON MANDELA</b>	
<b>AD 2.</b>		AD 2-1	19 MAY 2022
<b>SAL ISLAND / AMILCAR CABRAL</b>		AD 2-2	19 MAY 2022
AD 2-1	19 MAY 2022	AD 2-3	19 MAY 2022
AD 2-2	19 MAY 2022	AD 2-4	19 MAY 2022
AD 2-3	19 MAY 2022	AD 2-5	19 MAY 2022
AD 2-4	19 MAY 2022	AD 2-6	19 MAY 2022
AD 2-5	19 MAY 2022	AD 2-7	19 MAY 2022
AD 2-6	19 MAY 2022	AD 2-8	19 MAY 2022
AD 2-7	19 MAY 2022	AD 2-9	19 MAY 2022
		AD 2-10	19 MAY 2022

---

<i>Page</i>	<i>Date</i>
AD 2-11	19 MAY 2022
AD 2-12	19 MAY 2022
AD 2-13	19 MAY 2022
AD 2-14	19 MAY 2022
AD 2-15	19 MAY 2022
AD 2-16	19 MAY 2022
AD 2-17	19 MAY 2022
AD 2-18	19 MAY 2022
AD 2-19	19 MAY 2022
AD 2-20	19 MAY 2022
AD 2-21	19 MAY 2022
 <b>FOGO ISLAND / SAO FILIPE</b>	
AD 2-1	19 MAY 2022
AD 2-2	19 MAY 2022
AD 2-3	19 MAY 2022
AD 2-4	19 MAY 2022
AD 2-5	19 MAY 2022
AD 2-6	19 MAY 2022
AD 2-7	19 MAY 2022
AD 2-8	19 MAY 2022
 <b>SAO NICOLAU ISLAND / PREGUICA</b>	
AD 2-1	19 MAY 2022
AD 2-2	19 MAY 2022
AD 2-3	19 MAY 2022
AD 2-4	19 MAY 2022
AD 2-5	19 MAY 2022
AD 2-6	19 MAY 2022
AD 2-7	19 MAY 2022
AD 2-8	19 MAY 2022
 <b>SAO PEDRO / CESARIA EVORA</b>	
AD 2-1	19 MAY 2022
AD 2-2	19 MAY 2022
AD 2-3	19 MAY 2022
AD 2-4	19 MAY 2022
AD 2-5	19 MAY 2022
AD 2-6	19 MAY 2022
AD 2-7	19 MAY 2022
AD 2-8	19 MAY 2022
AD 2-9	19 MAY 2022
AD 2-10	19 MAY 2022
AD 2-11	19 MAY 2022
AD 2-12	19 MAY 2022
AD 2-13	19 MAY 2022
AD 2-14	19 MAY 2022
AD 2-15	19 MAY 2022
AD 2-16	19 MAY 2022
AD 2-17	19 MAY 2022
AD 2-18	19 MAY 2022
AD 2-19	19 MAY 2022
AD 2-20	19 MAY 2022
AD 2-21	19 MAY 2022
AD 2-22	19 MAY 2022
AD 2-23	19 MAY 2022
AD 2-24	19 MAY 2022
AD 2-25	19 MAY 2022
AD 2-26	19 MAY 2022
AD 2-27	19 MAY 2022
AD 2-28	19 MAY 2022
AD 2-29	19 MAY 2022
AD 2-30	19 MAY 2022

**INTENTIONALLY LEFT BLANK**

GEN 0.5 LIST OF HAND AMENDMENTS TO THE AIP

<b><i>AIP page(s) affected</i></b>	<b><i>Amendment text</i></b>	<b><i>Introduced by AIP Amendment NR</i></b>

**INTENTIONALLY LEFT BLANK**

**GEN 0.6 TABLE OF CONTENT TO PART 1**

Page

**GEN 0.**

GEN 0.1	PREFACE .....	GEN 0.1-1
GEN 0.2	RECORD OF AIP AMENDMENTS.....	GEN 0.1-1
GEN 0.3	RECORD OF AIP SUPPLEMENTS.....	GEN 0.3-1
GEN 0.4	CHECKLIST OF AIP PAGES.....	GEN 0.4-1
GEN 0.5	LIST OF HAND AMENDMENTS TO THE AIP.....	GEN 0.5-1
GEN 0.6	TABLE OF CONTENT TO PART 1 .....	GEN 0.6-1

**GEN 1. NATIONAL REGULATIONS AND REQUIREMENTS**

GEN 1.1	DESIGNATED AUTHORITIES.....	GEN 1.1-1
GEN 1.2	ENTRY, TRANSIT AND DEPARTURE OF AIRCRAFT.....	GEN 1.2-1
GEN 1.3	ENTRY, TRANSIT AND DEPARTURE OF PASSENGERS AND CREW.....	GEN 1.3-1
GEN 1.4	ENTRY, TRANSIT AND DEPARTURE OF CARGO.....	GEN 1.4-1
GEN 1.5	AIRCRAFT INSTRUMENTS, EQUIPMENT AND FLIGHT DOCUMENTS.....	GEN 1.5-1
GEN 1.6	SUMMARY OF NATIONAL REGULATIONS AND INTERNATIONAL AGREEMENTS / CONVENTIONS.....	GEN 1.6-1
GEN 1.7	DIFFERENCES FROM ICAO STANDARDS, RECOMMENDED PRACTICES AND PROCEDURES.....	GEN 1.7-1

**GEN 2. TABLES AND CODES**

GEN 2.1	MEASURING SYSTEM, AIRCRAFT MARKINGS, HOLIDAYS.....	GEN 2.1-1
GEN 2.2	ABBREVIATIONS USED IN AERONAUTICAL INFORMATION PRODUCTS.....	GEN 2.2-1
GEN 2.3	CHART SYMBOLS.....	GEN 2.3-1
GEN 2.4	LOCATION INDICATORS.....	GEN 2.4-1
GEN 2.5	LIST OF RADIO NAVIGATION AIDS.....	GEN 2.5-1
GEN 2.6	CONVERSION OF UNITS OF MEASUREMENT.....	GEN 2.6-1
GEN 2.7	SUNRISE / SUNSET.....	GEN 2.7-1

**GEN 3. SERVICES**

GEN 3.1	AERONAUTICAL INFORMATION SERVICES.....	GEN 3.1-1
GEN 0.1	AERONAUTICAL CHARTS.....	GEN 3.2-1
GEN 3.3	air TRAFFIC SERVICES.....	GEN 3.3-1
GEN 3.4	COMMUNICATION AND NAVIGATION SERVICES.....	GEN 3.4-1
GEN 3.5	METEOROLOGICAL SERVICES.....	GEN 3.5-1
GEN 3.6	SEARCH AND RESCUE.....	GEN 3.6-1

**GEN 4. CHARGES FOR AERODROMES / HELIPORTS AND AIR NAVIGATION SERVICES**

GEN 4.1	AERODROME / HELIPORT CHARGES.....	GEN 4.1-1
GEN 4.2	AIR NAVIGATION SERVICES CHARGES.....	GEN 4.2-1

**INTENTIONALLY LEFT BLANK**



## GEN 1. NATIONAL REGULATIONS AND REQUIREMENTS

### GEN 1.1 DESIGNATED AUTHORITIES

The addresses of the designated authorities concerned with facilitation of international air navigation are as follows:

#### 1.1.1. Civil Aviation

Civil Aviation Agency (AAC)  
Agencia de Aviacao Civil - ACC  
P.O. Box 371  
Praia  
Santiago Island  
Republic of Cabo Verde  
TEL: +238 2603430  
+238 2603431  
+238 2603432  
Telefax:+238 2611075  
e-mail: info@aac.cv  
AFS: GVPYAYX  
Http: www.aac.cv

#### 1.1.2. Meteorology

Instituto Nacional de Meteorologia e Geofisica  
Aeroporto Amilcar Cabral  
P.O. Box 76  
Espargos  
Sal Island  
Republic of Cabo Verde  
TEL: +238 2411658  
+238 2411276  
Telefax:+238 2411294  
e-mail: inmg.maa@gmail.com  
AFS: GVACYMYX  
Http: www.inmg.gov.cv

#### 1.1.3. Customs

Direcao Nacional das Receitas de Estado  
Direcao Geral das Alfandegas  
Av. Amilcar Cabral  
Praia  
Santiago Island  
Republic of Cabo Verde  
TEL: +238 2617758  
Telefax:NIL  
e-mail: helpdesk@dnre.gov.cv  
AFS: NIL  
Http: www.mf.gov.cv/web/dnre/direca-geral-das-alfandegas

#### 1.1.4. Immigration

Direcao Nacional da Policia Nacional  
Direcao de Emigracao e Fronteiras  
Praia  
Santiago Island  
Republic of Cabo Verde  
TEL: +238 2611845  
Telefax:NIL  
e-mail: NIL  
AFS: NIL  
Http: www.def.policianacional.cv/DNN

#### 1.1.5. Health

Misterio da Saude e Seguranca Social  
Palacio do Governo  
P.O. Box 47  
Praia  
Santiago Island

Republic of Cabo Verde  
TEL: +238 2610116  
Telefax:NIL  
e-mail: NIL  
AFS: NIL  
Http: www.minsaude.gov.cv

#### 1.1.6. En-route and aerodrome charges

ASA - Empresa Nacional de Aeroportos e Seguranca Aerea  
Aeroporto Amilcar Cabral  
Espargos  
Sal Island  
Republic of Cabo Verde  
TEL: +238 2419200  
Telefax:NIL  
e-mail: info@asa.cv  
AFS: GVACYGDG  
Http: www.asa.cv

#### 1.1.7. Agricultural quarantine

Ministerio da Agricultura e Ambiente  
P.O. Box 115  
Praia  
Santiago Island  
Republic of Cabo Verde  
TEL: +238 2615713  
+238 2615716  
Telefax:+238 2614054  
e-mail: NIL  
AFS: NIL  
Http: www.maa.gov.cv

#### 1.1.8. Aircraft accident investigation

Instituto de Prevencao e Investigacao de Accidentes Aeronauticos e Maritimos  
Rua Angola  
P.O. Box 7603  
Mindelo  
Sao Vicente Island  
Republic of Cabo Verde  
TEL: +238 2300992  
+238 2603430  
Telefax:NIL  
e-mail: infor@ipiaam.cv  
AFS: NIL  
Http: NIL

#### 1.1.9. Airport Slot Coordination

Slot Coordination Republic of Cabo Verde  
NIL  
TEL: +238 2419200  
+238 2419210  
+238 2419220  
Telefax: NIL  
e-mail: slot.coordination@asa.cv  
AFS: NIL  
Http: NIL

**INTENTIONALLY LEFT BLANK**

## GEN 1.2 ENTRY, TRANSIT AND DEPARTURE OF AIRCRAFT

### 1.2.1. General

1.2.1.1 The Republic of Cabo Verde exercises complete sovereignty over its airspace.

1.2.1.2 The Republic of Cabo Verde airspace is the airspace over the territory of the Cabo Verde archipelago and the adjacent territorial waters, being the Cabo Verde sovereignty a consequence of international legislation and the established international agreements.

1.2.1.3 All flights into, from or over the territory of the Republic of Cabo Verde, and the landings or departures in or from such territory shall be carried out in accordance with the under mentioned regulations, which shall apply on a reciprocal basis.

1.2.1.4 Aircraft landing or departing from the territory of the Republic of Cabo Verde must first land or finally depart from an international Airport (see **AD 1.3** Index to Aerodromes and Heliports).

Landings at aerodromes are subject to prior permission, and enquiries shall be addressed to the CIVIL AVIATION AGENCY (AAC) via <http://siga.aac.cv/ext/fpr>

1.2.1.5 The filing of a flight plan with the indications of the airport where landing or departure is to take place shall be a prerequisite.

1.2.1.6 Aircraft landing or departing from Level 3 Coordinated Airports (GVBA, GVNP and GVAC), shall submit a slot request prior to operate, referred on **ENR 1.9.3.3**.

### 1.2.2. Scheduled flights

#### 1.2.2.1 General

For regular International Scheduled Flights operated by foreign airlines into or in transit across the Republic of Cabo Verde, the following requirements must be met:

##### 1.2.2.1.1 Over flights or Non - traffic Stops

The over flights or landings for non - traffic purposes can be performed if the airline has been designated under a bilateral agreement signed by the Republic of Cabo Verde or under the international Air services Transit Agreement, provided that the State in which the aircraft is registered is a part of either agreement. It is further required that the over flights or landings are made in accordance with the timetable to, and approved by CIVIL AVIATION AGENCY (AAC).

##### 1.2.2.1.2 Traffic Stops

1.2.2.1.2.1 Landing for traffic purposes require the airline to have been designated pursuant to a bilateral agreement signed by the Republic of Cabo Verde and the State in which the aircraft is registered.

1.2.2.1.2.2 Pending the signature of a bilateral agreement, the airline may obtain a temporary permit for the purposes mentioned in **GEN 1.2.2.1.1** and **GEN 1.2.2.1.2** in case the matter must be dealt with through diplomatic channels.

### 1.2.3. Non-scheduled flights

#### 1.2.3.1 Categories of non - scheduled flights

1.2.3.1.1 For the purpose of authorisation, the non - scheduled

flights fall into the following categories:

1.2.3.1.1.1 Single flights, when performed in a number not exceeding one per month per operator, in both directions.

1.2.3.1.1.2 Short series of flights, when performed in a number not exceeding four per month per period of two successive calendar month, per operator or group of operators.

1.2.3.1.1.3 Long series flights, when performed in a number not exceeding the maximum established for the short series of flights, in accordance with the remaining elements of the shorts series definition.

1.2.3.1.2 When required under these regulations, permission for non - scheduled flights shall be given by CIVIL AVIATION AGENCY (AAC), in the remaining cases.

1.2.3.1.3 Applications and notifications in these regulations shall be addressed to CIVIL AVIATION AGENCY(AAC).

1.2.3.1.4 CIVIL AVIATION AGENCY (AAC) may require the operator to provide any additional information on the flights referred to in **GEN 1.2.3** and prohibit such flights when they impair scheduled air services.

1.2.3.1.5 Subject to the maximum time limits established under **GEN 1.2.3.1.1** of these regulations, notifications and applications for non - scheduled flights, as well as any alteration for their operating conditions, shall be sent to the CIVIL AVIATION AGENCY (AAC) as far in advance as possible for reasons of safety and facilitation and also to ensure a more advanced reply.

1.2.3.1.6 Applications for non - scheduled flights shall be examined having regard to observance of the provisions of these regulations and other technical, financial and operational conditions.

1.2.3.1.7 Permission for non - scheduled flights by foreign operators may depend on reciprocal treatment being given to Cabo Verde operators.

1.2.3.1.8 Except in the case of humanitarian and emergency flights, a foreign carrier wishing to start non - scheduled flights into and out of The Republic of Cabo Verde territory may be requested to meet the following requirements:

- a) To be registered in the CIVIL AVIATION AGENCY (AAC) as an operator authorised to perform non - scheduled flights.
- b) To have filed with the CIVIL AVIATION AGENCY (ACC) a bank guarantee issued by a Cabo Verde bank for the purpose of insuring not only the fulfilment of these obligations, including the obligations assumed towards his passengers under the charter contract, but also the payment of fees and other charges for which he is responsible.
- c) To have filed a certificate of liability for damages to passengers, baggage and cargo or to third parties on the surface.

1.2.3.1.9 The CIVIL AVIATION AGENCY (AAC) may refuse permission for non - scheduled flights where the aircraft charterer does not meet the above conditions or does not comply with the provisions of these regulations.

1.2.3.1.10 The CIVIL AVIATION AGENCY (AAC) may cancel permissions already granted to an infringing operator or prohibit temporary or permanently, from flying into or out The Republic of Cabo Verde territory.

1.2.3.1.11 The CIVIL AVIATION AGENCY (AAC) shall be responsible for enforcement of these regulations through officers appointed for the purpose, who shall have access to outgoing

aircraft, places where tickets are sold or checked and the hotels or similar establishments.

#### 1.2.3.2 Description of types of charters

1.2.3.2.1 For the purposes of this document the three basic types of charters are categorised as follows:

- a) Group charters;
- b) Inclusive tour charters;
- c) Single entity (or own use) charters;
- d) Other specialised charters and concepts are also described herein.

1.2.3.2.2 Groups charters are divided into two categories i.e. affinity and non affinity group charters.

1.2.3.2.2.1 Affinity group charters are based upon the rules established by IATA in Resolution 045 which stipulates that, to be eligible, a group must have principle purposes, aims and objectives other than travel sufficient affinity existing prior to the application for charter transportation to distinguish it and set it apart from the general public. Further more, the group may not exceed 50 members. The entire capacity of the aircraft must be chartered, although more than one charterer can be involved, in that case, not more than three groups of only one nature (affinity groups) may be carried on the same flight, provided that each group consists of not less than forty participants.

1.2.3.2.2.2 Non affinity group charters were introduced by a number of North American and European States pursuant to the conclusions of the Ottawa Declaration in 1972. These charters are mainly termed as advance booking charters. The rules governing non affinity charters are that the full capacity of the aircraft be chartered, and that each charterer contract for at least forty seats, and that passengers book at least sixty days in advance. The ABC (the advance booking charter) price is a fixed price set by the organizer.

1.2.3.2.3 Inclusive tour charters which may be offered to the members of the general public by a tour operator for a round trip which includes accommodation and other ground arrangements. The entire capacity of the aircraft is chartered and the price is set by the tour operator.

1.2.3.2.4 Single entity or (own use charters) are permitted when a private person or corporation charters an aircraft for his or its own use for the carriage of freight or passengers, on condition that passengers do not share in the costs either directly or indirectly. Such charters are used increasingly as part of sales incentive programmes.

1.2.3.2.5 Specialised charters include mainly:

- a) Humanitarian or emergency needs charters;
- b) Passenger taxi - class charters;
- c) Student charters;
- d) Special event charters;
- e) Migrant worker charters;
- f) All - cargo charters.

1.2.3.2.6 Humanitarian charters for emergency needs charters are self explanatory and refers to aircraft chartered for the purposes of meeting humanitarian or emergency needs and calls for special treatment of such flights.

1.2.3.2.7 Taxi - class passenger charters refer to aircraft chartered for passenger flights of the occasional charter on request provided that the aircraft does not have a seating capacity more than six passengers.

1.2.3.2.8 Student or study groups charters may be operated when the entire capacity of the aircraft is chartered for the carriage of full

time students at a recognised establishment of higher education, and sponsored by a recognised institution of students association, with the following age limitations:

- a) Students up to the age of 30 years undergoing a full time course of study at a university or other establishments of higher education;
- b) Scholars between the age of 16 and 22 years in full time attendance for a minimum of a full school year at a recognised educational establishment;
- c) Any number of groups may be carried on the aircraft, provided that each group consists of a least 40 student participants;
- d) Members on the teaching staff or other persons as leaders of a group of students scholars;
- e) Wives and husbands of eligible students, scholars or leaders as well as their dependant children up to the age of 18 years;
- f) Past students and scholars up to 31 December of the year in which they completed their courses;
- g) The declaration form in **GEN 1.2.3.4** must be submitted to the CIVIL AVIATION AGENCY(AAC).

1.2.3.2.9 Special events charters are for the carriage of one or more groups to attend or participate in special events of a religious, sporting, cultural, social, professional or other nature. The aircraft can only be operated to the country where the special event takes place and the duration of the stay is related to the duration of the event.

1.2.3.2.10 Migrant worker charters may be considered for the carriage of migrant workers. The aircraft can only be operated to the places of destination where the migrant workers will be radiated.

1.2.3.2.11 All cargo charters by forwarders and consolidators are permitted to operate such flights with the share of the aircraft capacity by a number of consignors or consignees. It is a general practice to prohibit the mixed carriage of cargo and passengers on a charter flight.

1.2.3.2.12 In defining other concepts in the various types of charters generally permitted, it is necessary to outline some special concepts that apply to the operation of charters. They involve the so called split - charters leading to the right for more than one chartering entity to share or split the capacity of a chartered aircraft. Normally the permission for such charters involves a contract of at least 40 seats, with the number of groups being limited to 3. These split charters may involve the following arrangements consisting of intermingling or mixed charters. The commingling designates the carriage of more than one type of charter on a split charter flight for instance, advance booking charter groups student charter, etc. The intermingling allows split charter groups which have flown together on the outward leg of a journey to return on a different date on a different aircraft. The mixed charter involves a charter operation whose cost is borne partly by the charterer and partly by the participants, as opposed to a pro rata charter. Finally, it should be noted that in some cases it is regarded as a charter or as a series of charters when the so called wet lease, corresponding to an aircraft leased with the crew.

#### 1.2.3.3 Procedures

##### 1.2.3.3.1 Non scheduled over flights or Non - traffic Stops

###### 1.2.3.3.1.1 Aircraft registered in ICAO States

The operator of an aircraft registered in any ICAO contracting State may carry out a non - scheduled flight or a series of such flights in transit across or make non - traffic stops in the territory of The Republic of Cabo Verde without the necessity of obtaining prior permission, subject however to reciprocal treatment being granted to Cabo Verde aircraft in the country of the operator. Failing this, the procedure set forth under **GEN 1.2.3.3.1.2** below shall apply. The flight plan for the above operations shall be regarded as sufficient

prior notification, provided that it contains the details listed in **GEN 1.2.3.3.1.3**

#### 1.2.3.3.1.2 Aircraft registered in Non - ICO States

For aircraft listed in any State not a member of ICAO, the operations mentioned under **GEN 1.2.3.3.1.1** require prior permission, which must be applied for through diplomatic channels. Applications must contain the details listed in **GEN 1.2.3.3.1.3**.

1.2.3.3.1.3 The following information is required for non - scheduled overflights or non traffic stops:

- a) Name of operator
- b) Type of aircraft and registration marks
- c) Date and time of arrival and departure from the airport concerned
- d) Itinerary
- e) Purpose of the flight, nature and amount of cargo carried on board

#### 1.2.3.3.2 Traffic Stops

##### 1.2.3.3.2.1 General

- a) For the purpose of these regulations, non - scheduled flights are categorised and defined in **GEN 1.2.3.1** hereto.
- b) Non - scheduled operators may be requested by AAC to produce evidence, in the form of a certificate of competence, that their international operations are conducted in accordance with the laws and regulations of the State of registry of the aircraft.

##### 1.2.3.3.2.2 Aircraft registered in ICAO States

- a) If the operator of an aircraft registered in any ICAO contracting State intends to perform a non - scheduled flight or series of such flights into Cape Verde for the purpose of loading or off - loading of passengers or cargo, he may do so in accordance with the procedures as prescribed in paragraphs b) through to f).
- b) Single Entity, Humanitarian or Emergency needs or Passenger Taxi Flights.

These flights, are referred to in **GEN 1.2.3.2.4**, **GEN 1.2.3.2.6** and **GEN 1.2.3.2.7** and may be performed without the necessity of obtaining a prior notification. Prior notification to the CIVIL AVIATION AGENCY(AAC) is, however, required and must contain the details listed below, which shall be applied at least one working day before the intended landing.

The following information is required for non - scheduled traffic stops:

- a) Name of operator
- b) Type of aircraft and registration marks
- c) Date and time of arrival and departure from the Cabo Verde airport concerned
- d) Place or places of embarkation or disembarkation abroad, as the case may be, passengers and / or freight
- e) Purpose of flight and number of passengers and / or the nature and amount of freight
- f) Name, address and business of charterer, if any

*Note: The operator may be required to submit such additional information as is deemed necessary for the consideration of the request.*

#### c) Other General Charter flights

For other general charter flights not covered by paragraph b) prior authorisation from the CIVIL AVIATION AGENCY (AAC) is required and must contain the details listed in **GEN 1.2.3.4**, 1 - 12 of these regulations. Exceptions made to the affinity, non -

affinity (advance booking), inclusive tours for student charters, which are treated in the following paragraphs, the authorisation to perform a non - scheduled flight or a series of flights, in the condition referred to in paragraph d shall be applied at least two working days before the intended landing.

#### d) Affinity Group Charters

For these flights, designated in **GEN 1.2.3.2.2.1** to these regulations, the application referred to in paragraph d shall be applied to CIVIL AVIATION AGENCY (AAC) not less than 30 days before the date of flight accompanied by:

- i. Declaration from chartering organisation made in accordance with **GEN 1.2.3.4**;
- ii. List of participants.

#### e) Non - affinity Group Charters

For flights, defined in **GEN 1.2.3.2.2.2** to these regulations, the applications referred to in paragraph d) shall be applied to CIVIL AVIATION AGENCY (AAC) not less than 30 days before the date of the flights accompanied by:

- i. Declaration in a form similar to that of **GEN 1.2.3.4** hereto:
- ii. List of participants.

#### f) Inclusive Tour Charters

For these flights, defined in **GEN 1.2.3.2.3** to these regulations, the applications referred to in paragraph c shall be applied to the CIVIL AVIATION AGENCY (AAC) not less than 30 days before the date of the flights accompanied by a list of participants.

1.2.3.3.2.3 For these flights, defined in **GEN 1.2.3.2.3** for these regulations, the application referred in paragraph c shall be applied to the CIVIL AVIATION AGENCY (AAC) not less than 30 days before the date of the flights accompanied by:

- a) Declaration in a form similar to that of **GEN 1.2.3.4** hereto;
- b) List of participants.

##### 1.2.3.3.2.4 Aircraft registered in Non - ICAO States

For aircraft registered in any State not a member of ICAO, the operator of non - scheduled flights into Cabo Verde for the purpose of picking up or putting down passengers or cargo, requires prior permission, which must be applied for through diplomatic channels fulfilling the provisions and accompanied by the details referred to in **GEN 1.2.3.3.1**.

1.2.3.4 Request for authorisation for a non - scheduled flight Applications shall be submitted to CIVIL AVIATION AGENCY (AAC) for authorisation, by using the applicable form, available at:

<http://siga.aac.cv/ext/fpr>

#### 1.2.4. Private flights

##### 1.2.4.1 Advance notification of arrival

###### 1.2.4.1.1 Aircraft registered in ICAO States

Aircraft registered in any ICAO State, subject to reciprocal treatment, do not need prior permission to fly into The Republic of Cabo Verde, and the respective flight plan is accepted as adequate in advance notification to the arrival of incoming aircraft. This information must, however be transmitted in such a way that it will be received by the aviation authorities at least two hours in advance of arrival; the landing must be carried out at previously designated international airport.

Permits can be provided for a window of 48 or 72 hours when so requested in the application.

**Note:** For reasons of flight safety and compliance with airport regulations, landing permits are required for Private Non - Commercial Flights. Applications must be submitted to AAC in time deemed necessary to allow for a response before the commencement of flight. On weekends, after 16:00 of every working day and national public holidays, urgent application must be addressed to GVACYNYX for the Attention of the Duty Airport Operations Supervisor Tel / Fax: +238 241 1309.

#### 1.2.4.1.2 Aircraft registered in Non - ICAO States

For private flights by aircraft registered in a non - ICAO State or in any case where reciprocity may not exist, special permission is required in addition to filing of a flight plan, and must be applied for through diplomatic channels.

### 1.2.5. Military and Diplomatic Flight

#### 1.2.5.1 General

For the purpose of these regulations the following aircraft are considered Military and diplomatic Flight.

- a) Military Aircraft;
- b) Aircraft used in customs and police services;
- c) Aircraft engaged in the official carriage of heads of States or Government and respective train of attendants provided that no other passengers are carried;
- d) civil aircraft engaged in the carriage of weapons, munitions, and other military equipment;
- e) Aircraft under United Nations Organisations services.

Military and Diplomatic Flight are subject to prior permission for overflying the territory of The Republic of Cabo Verde or landing at a Cabo Verde airport.

#### 1.2.5.2 Application Procedures

1.2.5.2.1 Applications regarding overflight or landing of Military and Diplomatic Flight must be submitted to the Ministry of foreign Affairs, through the usual diplomatic channels, for clearance. For the benefit of the clearance expedition, the use of Fax: +238 261 1960 and Email: mnecomunidades@gmail.com, is encouraged.

1.2.5.2.2 The request must reach the Ministry Office at least 3

working days prior to the flight.

1.2.5.2.3 Requests submitted later will only be dealt in well - founded cases such as duly justified urgency, or unexpected heads of State or Government flights, rescue, or humanitarian flights.

1.2.5.2.4 Confirmation of clearance must be received by the applicant before starting the flight.

1.2.5.2.5 The request must contain the following information:

- a) State of registry;
- b) Owner or aircraft operator, including address;
- c) Type and number of aircraft;
- d) Registration mark;
- e) Radio call sign;
- f) Point of departure and final destination;
- g) Exact flight route;
- h) Information about the crew and passengers;
  - i. Name, rank and nationality of the pilot in command, number of the crew;
  - ii. Members and passengers for each flight, for military aircraft;
  - iii. Name and nationality of the pilot in command, number of the crew members and passengers for each flight, for civil aircraft.
- i) Exact purpose of the flight and nature of freight, when carried;
- j) Information deemed necessary to support the required assistance on the ground, e.g. amount and type of fuel / oil grades;
- k) Declaration that the pilot in command is familiar with the air navigation procedures applied within The Republic of Cabo Verde airspace, and that the aircraft operator will comply with the national legislation regarding indemnities to third parties for damages on the ground.

### 1.2.6. Documentary Requirements

1.2.6.1 Documentary requirements for clearance of scheduled and non - scheduled flight aircraft.

It is necessary that the under mentioned aircraft documents are submitted by airline operators for clearance on entry and departure of their aircraft to and from The Republic of Cabo Verde. All documents listed below in legible handwriting. No visas are required in connection with such documents.

Required by	General declaration	Passenger Manifest	Cargo Manifest
Airport Authority	Required	Required	Required

- a) One copy of General Declaration and Cargo Manifest is endorsed and returned by Customs, signifying clearance;
- b) If no passengers are embarking (disembarking) and no articles are laden (unladen), no aircraft documents except copies of the General Declaration need be submitted to the above authorities.

**Note:** General Declaration is required only to flights that do not receive handling assistance by the national company. when the flights are attended by the national company, a traffic form that replaces the general declaration and the passenger manifest is required.

1.2.6.2 Documentary requirements for clearance of private flight aircraft.

Applications must obtain the following information to the required flight plan:

- a) Name of aircraft, owner / operator and full address;
- b) Type of aircraft and registration mark;
- c) Date and time of arrival and departure from the airport;
- d) concerned itinerary;
- e) Purpose of the flight and nature of cargo when carried must follow the ICAO standard format as set forth in the relevant appendices to ICAO Annex 9 and are acceptable when furnished in English and completed;
- f) Any other relevant information such as the amount and type of fuel required and special / specific handling requirements.

### 1.2.7. Public health measures applied to aircraft

1.2.7.1 All inbound aircraft from Africa including aircraft operating on domestic flights are required to perform a disinfection

operation before landing at Cape Verde airports.

The record of this operation on the general declaration (according to ICAO Annex 9, chapter 2, paragraph 2.23 and 2.24) or the attestation on the cargo manifest by the competent airport health control of origin of the flight shall be accepted by the local airport authorities as evidence that effective disinfecting has been carried out.

Should disinfecting not have been previously carried out for any reason, the pilot when in radio contact with Sal control, must advise that disinfecting has not been carried out and request it to be done.

Occasionally airport authorities may require additional disinfecting to be performed by competent airport personnel just after landing. Should this occur pilots / operators are requested to give strict instructions to their crew to facilitate the operation and avoid any inconvenience or delay to the flight.

**INTENTIONALLY LEFT BLANK**



## GEN 1.3 ENTRY, TRANSIT AND DEPARTURE OF PASSENGERS AND CREW

### 1.3.1. Customs requirements

Baggage or articles belonging to disembarking passengers and crew are immediately released except for those selected for inspection by the customs authorities. Such baggage will be cleared on the basis of verbal declaration except in the case of returning citizens.

### 1.3.2. Immigration requirements

1.3.2.1 Passports and visas are required for arriving and departing passengers.

1.3.2.2 Baggage identification is normally required on departure.

1.3.2.3 A person entering the Republic of Cabo Verde for immigration purposes must hold a valid passport and an immigration visa, the latter being issued at Cabo Verde Consulates abroad.

1.3.2.4 Procedures Relating to Entrance Visas.

1.3.2.4.1 Passengers in transit not exempted from consular visa on arriving at any Cabo Verde International Airport without it may be permitted to stay in Cabo Verde territory for four days.

1.3.2.4.2 Passengers wishing to enjoy this privilege shall leave their passports at the Police Office at the Airport, in exchange for a 283 - format card.

1.3.2.4.3 No consular fees shall be due for disembarkation taking place as provided for in sub - section 1.3.2.4.1 and sub - section 1.3.2.4.2.

1.3.2.4.4 Passengers wishing to prolong their stay in Cabo Verde beyond the time - limit mentioned in sub - section 1.3.2.4.1 may be allowed to do so for an additional six - day period.

1.3.2.4.5 To this end and upon surrender of the 283 - format card passengers will be given back their passports at the airport Police Office.

1.3.2.4.6 The normal consular fee of about USD 10.00 for visas shall be collected from foreign passengers availing themselves of the above practice.

1.3.2.4.7 As a rule, none of the privileges above referred to shall be granted, except to subjects of foreign countries with diplomatic or consular representatives in Cabo Verde, it being further necessary that the airlines should guarantee the transportation of the passengers in question within the time - limit granted for their stay in Cabo Verde.

### 1.3.3. Public health requirements

1.3.3.1 Disembarking passengers are not required to present vaccination certificates except when coming directly from an area with yellow fever.

1.3.3.2 Should a massive return of national citizens from an area infected with cholera, yellow fever or Malaria occur, public health authorities may select some disembarking passengers for a medical examination.

1.3.3.3 On departure, no health formalities are required.

**INTENTIONALLY LEFT BLANK**

**GEN 1.4 ENTRY, TRANSIT AND DEPARTURE OF CARGO**

To be developed

**INTENTIONALLY LEFT BLANK**

## GEN 1.5 AIRCRAFT INSTRUMENTS, EQUIPMENT AND FLIGHT DOCUMENTS

### 1.5.1. General

Commercial air transport aircraft in Cabo Verde must adhere to provisions of ICAO Annex 6 - Operation of Aircraft, Part 1 - International Commercial Air Transport - Aeroplanes, Chapter 6 (Aeroplane Instruments) and Chapter 7 (Aeroplane Communication and Navigation Equipment).

### 1.5.2. Instruments and Equipment to be carried

1.5.2.1 Except when a Special Exemption has been granted by Air Traffic Services, aircraft flying within SAL OCENIC FIR / UIR shall be equipped with and maintain in operation SSR Transponder capable of responding to Mode A interrogations with 4096 codes and Mode C interrogations with Automatic Pressure Altitude information.

1.5.2.2 ACAS II - As required by ICAO SUPPS Doc 7030 / 4, ACAS II shall be carried and operated in the SAL OCENIC FIR / UIR by all aircraft that meet the following criteria:

- a) All civil fixed wing turbine - engine aircraft having a maximum take - off mass exceeding 15 000 KG, or a maximum approved passenger seating configuration of more than 30, will be required to be equipped with ACAS II.
- b) With effect from 1<sup>st</sup> January 2005, all civil fixed wing turbine - engine aircraft having a maximum take - off mass exceeding 5 700 KG, or a maximum approved passenger seating configuration of more than 19, will be required to be equipped with ACAS II.

1.5.2.3 Aircraft, other than State aircraft, operating on the RNAV routes described in **ENR 3.3** within the SAL OCENIC FIR / UIR shall be equipped with, as a minimum, RNAV equipment meeting RNP 10 in accordance with the requirements set out in ICAO Doc 7030 Regional Supplementary Procedures.

1.5.2.4 Standard equipment is considered to be VHF, HF, VOR and ILS which shall be carried within SAL OCENIC FIR / UIR.

1.5.2.5 A local flying restriction is imposed upon aircraft in that they will not be accepted without two way radio communication.

1.5.2.6 Subject to the observances of the application, rules, conditions and limitations set forth in this document and in the legislation described in **1.5.2.2** foreign civil aircraft registered in any foreign country which at the time are a member of ICAO may be navigated in Cabo Verde.

1.5.2.7 Aircraft registered under the laws of foreign countries, not members of the ICAO, which grant reciprocal treatment to Cabo Verde aircraft and airmen, and the limitations applicable in the case of aircraft of ICAO member states.

### 1.5.3. Equipment to be carried on all internal and on certain flights

1.5.3.1 On internal flights and on flights with single engined and multi engined aircraft which are not capable of maintaining prescribed minimum safe altitude in the event of engine failure, the signalling equipment in sub - section **1.5.4.2** shall be carried.

#### 1.5.3.2 Signalling equipment

The following signalling equipment shall be carried:

- a) An emergency locator transmitter (ELT);
- b) Two signal flares of the day and night type;
- c) Eight red signal cartridges and a means of firing them;
- d) A signal sheet (minimum 1 x 1 M) in a reflecting colour;
- e) An electric hand torch.

### 1.5.3.3 Survival equipment

The following survival equipment shall be carried:

- a) A compass;
- b) A knife;
- c) A sleeping bag with a waterproof inner lining or a rescue blanket (Astron) per person;
- d) Four boxes of matches in waterproof containers;
- e) A ball of string;
- f) A cooking stove with fuel and the accompanying cooking and eating utensils.

### 1.5.4. Flight Documents to be carried

NIL

**INTENTIONALLY LEFT BLANK**

## GEN 1.6 SUMMARY OF NATIONAL REGULATIONS AND INTERNATIONAL AGREEMENTS / CONVENTIONS

### 1.6.1. General

A list of civil aviation legislation is mentioned below. It is essential that persons engaged in air operations within the area of responsibility of the Republic of Cabo Verde are acquainted with the relevant regulations.

Official publication of the relevant regulations can be found online at the following website:

Http: [www.aac.cv/navsite/legislacao-aac/doc](http://www.aac.cv/navsite/legislacao-aac/doc)

Copies of the documents may be obtained from:

Agencia de Aviacao Civil - ACC  
P.O. Box 371  
PRAIA  
SANTIAGO ISLAND  
Republic of Cabo Verde  
TEL: +238 2603430  
+238 2603431  
+238 2603432  
Telefax:+238 2611075  
e-mail: [info@aac.cv](mailto:info@aac.cv)  
AFS: GVPRYAYX  
Http: [www.aac.cv](http://www.aac.cv)

### 1.6.2. National Legislation on Civil Aviation

References	Contents
Aeronautical Code	Approved by Legislative Decree No. 1 / 2001 of 20 August, as amended by the Legislative Decree No. 4 / 2009 of 7 September - Official Gazette Series I, No. 35
Statutes of Civil Aviation Agency	Approved by Decree - Law No. 28 / 2004, of 12 July, as amended by Decree - Law No. 31 / 2009 of 7 September - Official Gazette Series I, No. 35
Decree - Law No. 14 / 2009 of 25 May approves the National Program for Civil Aviation Security	Republished 10 August, 2009 in Official Gazette Series I, No. 32
Decree - Law No. 46 / 2003 of 10 November	Creates within the Institute of Civil Aeronautics, The National Commission for Air Transport Facilitation and Civil Aviation Security - designated the National Commission FAL / SEC - Official Gazette No. 38
Decree - Law No. 37 / 2006 of 3 July	Approves the Regulation related to entry, overflight and exit of the national territory for foreign aircraft - Official Gazette No. 19
Decree - Law No. 9 / 80, 11 February	Establishes the Oceanic Flight Information Region - Sal Oceanic FIR - Official Gazette No. 6
Resolution No. 1 / 2007 of the Board of Directors of AAC, published in Official Gazette No. 26, II Series, of 4 July 2007	Approves the formula for calculating air navigation en - route fees in the Sal oceanic FIR
Resolution No. 2 / 2007 of the Board of Directors of AAC, published in Official Gazette No. 36, II Series of 12 September 2007	Approves the terminal navigation fees; changes in landing, take - off and parking fees, as well as changes in passengers' fees in international operations
Decree - Law No. 34 / 2009	Establishes search and rescue services for civil aviation to be provided throughout the airspace designated as Sal Search and Rescue Oceanic Region - Official Gazette Series I, No. 37, 21 September
Ordinance No. 34 / 2009 of 28 September	Publishes the Cape Verde Civil Aviation Search and Rescue Region
Decree - Law No. 38 / 2009	Establishes the principles governing the technical investigation, under the responsibility of Cape Verde State, of aircraft accidents and serious incidents and establishes the Commission for the Prevention and Investigation of Aviation Accidents - Official Gazette Series I, No. 38, 28 September
Decree - Law No. 18 / 2009 of 22 June	Establishes the General regime of Aviation Servitudes - Official Gazette Series I, No. 38, 22 June
Decree No. 8 / 96 of 10 December	Approves for adherence of Cape Verde to the Convention on Search and Rescue - in Official Gazette No. 41, Suppl.
Resolution No. 43 / 2002 of 27 May	Approves for Adherence, the Protocol on the Suppression of Unlawful Acts at Airports Serving International Civil Aviation, supplementary to the Convention for the Suppression of Unlawful Acts against the Safety of Civil Aviation signed at Montreal on 24 February 1988 - Official Gazette No. 15
Resolution No. 18 / 2003 of 18 August	Publishes the Convention on International Civil Aviation, signed at Chicago on December 7, 1944 - Official Gazette No. 26
Resolution No. 93 / VI / 04, 31 May	Approves for Adherence, the Supplementary Convention to the Warsaw Convention for Unification of Certain Rules Relating to International Carriage by air done by other Entity than the Contractual carrier - Official Gazette No. 16
Resolution No. 101 / VI / 2004, 21 June	Approves for ratification, the Protocol relating to an amendment to paragraph a) of Article 50 of the Convention on International Civil Aviation of 1944, signed on 26 October 1990 - Official Gazette No. 19
Resolution No. 102 / VI / 2004, 21 June	Approves, for ratification, the Protocol relating to an amendment to Article 56 of the Convention on International Civil Aviation, signed on 26 October 1989 - Official Gazette No. 19

<i>References</i>	<i>Contents</i>
Resolution No. 103 / VI / 2004, 21 June	Approves, for Adherence, the Convention for the Unification of Certain Rules for International Carriage by Air, signed at Montreal on May 28, 1999 - Official Gazette No. 19
Decree with Force of Law No. 14 / 76 of 6 July	Air Services Agreement between the Government of the Republic of Cape Verde and the Government of the Republic of Portugal - Official Gazette 27 /76
Decree with Force of Law No. 22 /76 of 27 November	Ratifies the Agreement on Air navigation concluded between the Government of the Republic Cape Verde and the government of the Republic of Portugal - Official Gazette 27 /76
Decree No. 68 /90 of 18 August	Approves the Agreement on Civil Aviation Security between the Government of the Republic of Cape Verde and the Government of the United States of America - Official Gazette No. 33
Decree No. 149 /90 of 22 December	Approves the Agreement between the government of the Republic of Cape Verde and the Kingdom of The Netherlands concerning Air Services and beyond their respective territories - Official Gazette No. 51
Decree No. 4 / 97 of 17 March	Approves the Agreement between the Government of the Republic of Cape Verde and the Government of the former Union of Soviet Republics concerning Air Services - Official Gazette No. 10

**1.6.3. Summary of International Agreements / Conventions**

NIL



---

**GEN 1.7 DIFFERENCES FROM ICAO STANDARDS, RECOMMENDED PRACTICES AND PROCEDURES**

1.7.1. The list of differences from ICAO standards, recommended practises, and significant differences from procedures is available on the Civil Aviation Authority (AAC) website at: [www.aac.cv/navdoc/89](http://www.aac.cv/navdoc/89) or by contacting the Civil Aviation Authority:

Agencia de Aviacao Civil - ACC  
P.O. Box 371  
Praia  
Santiago Island  
Republic of Cabo Verde  
TEL: +238 2603430  
+238 2603431  
+238 2603432  
Telefax:+238 2611075  
e-mail: [info@aac.cv](mailto:info@aac.cv)  
AFS: GVPYAYX  
Http: [www.aac.cv](http://www.aac.cv)

**INTENTIONALLY LEFT BLANK**

**GEN 2. TABLES AND CODES**

**GEN 2.1 MEASURING SYSTEM, AIRCRAFT MARKINGS, HOLIDAYS**

**2.1.1. Units of measurement**

The units of measurement shown below will be used by all ground and air operations within the SAL OCENIC FIR / UIR in accordance with ICAO Annex 5.

<i>Measurement of</i>	<i>Units used</i>
Distance used in navigation, position reporting, etc.	Nautical Miles
Relatively short distances such as those relating to airports (e.g runway length)	Metres
Altitudes, elevations and heights	Metres or Feet
Horizontal speed including wind speed	Knots
Vertical speed	Feet per minute
Wind direction for landing and taking off	Degrees Magnetic
Wind direction except for landing and taking off	Degrees True
Visibility including runway visual range	Kilometres or Metres (visibility of less than 5 KM may be given in Metres)
Altimeter setting	Hectopascal (HPA)
Temperature	Degrees Celsius
Weight	Metric Tons or Kilograms
Time	Hours and Minutes, beginning at midnight UTC

**2.1.2. Temporal Reference System**

2.1.2.1 Coordinated Universal Time (UTC) is used in the air traffic and communication services and in documents published by the Aeronautical Information Service.

2.1.2.2 The local time for Cabo Verde is: UTC -1 hour.

**2.1.3. Horizontal reference datum**

**2.1.3.1 Name of the reference system**

All published geographical coordinates indicating Latitude and Longitude, are expressed in terms of World Geodetic System - 1984 (WGS - 84) Geodetic Reference Datum.

**2.1.3.2 Name and parameters of the projection**

The projection used is the Lambert Conformal Conic projection.

**2.1.3.3 Ellipsoid**

The World Geodetic System of 1984 (WGS-84) is used.

**2.1.3.4 Datum**

The World Geodetic System of 1984 (WGS-84) is used

**2.1.3.5 Area of application**

The area of application for the published geographical coordinates coincides with the area of responsibility of the Aeronautical

Information Service, i.e., the entire territory of the SAL OCENIC FIR / UIR.

**2.1.3.6 Use of an Asterisk to identify published geographical coordinates**

An asterisk (\*) will be used to identify those published geographical coordinates which have been transformed into WGS - 84 coordinates but whose accuracy of original field work does not meet the requirements in ICAO Annex 11, Chapter 2, and ICAO Annex 14 Volumes I and II Chapter 2. Specifications for determination and reporting of WGS - 84 coordinates are given in ICAO Annex 11, Chapter 2, and in ICAO Annex 14, Volumes I and II, Chapter 2.

**2.1.4. Vertical reference system**

**2.1.4.1 Name / designation of the system**

The vertical reference system corresponds to mean sea level (MSL).

**2.1.4.2 Geoid model**

The geoid model used for height transformation is the Earth Gravitational Model 2008 (EGM08).

**2.1.5. Aircraft nationally and registration marks**

The nationality mark for aircraft registered in Cabo Verde are the letters D4. The nationality mark is followed by a hyphen and a registration mark consisting of 3 letters, e.g. D4 - ABC.

**2.1.6. Public holidays**

New Years Day	01 January
Freedom's Day	13 January
National Heroes Day	20 January
Good Friday*	Friday before Easter

Labour Day	01 May
Children Day	01 June
Independence Day	05 July
Saint's Day	15 August
All Saint's Day	01 November
Christmas Day	25 December

**Note:** Air traffic services are not affected.

**Note:** Dates of public holidays with an asterisk (\*) will change yearly.

## GEN 2.2 ABBREVIATIONS USED IN AERONAUTICAL INFORMATION PRODUCTS

† When radio telephony is used, the abbreviations and terms are transmitted as spoken words.

‡ When radio telephony is used, the abbreviations and terms using the individual letters in non - phonetic form.

\* Signal is also available for use in communicating with the maritime service.

# Signal for use in the teletypewriter service only.

**A**

A	Amber	AGN	Again
AAA	(or AAB, AAC . . . etc., in sequence)	AIC	Aeronautical information circular
	Amended meteorological message (message type designator)	AIDC	Air traffic services inter - facility data communication
A/A	Air-to-air	AIM	Aeronautical information management
AA/M	Aircraft autonomous integrity monitoring	AIP	Aeronautical information publication
AAD	Assigned altitude deviation	AIRAC	Aeronautical information regulation and control
AAL	Above aerodrome level	AIREP †	Air-report
AAR	Air to air refuelling	AIRMET †	Information concerning en-route weather phenomena which may affect the safety of low-level aircraft operations
ABI	Advance boundary information	AIS	Aeronautical information services
ABM	Abeam	ALA	Alighting area
ABN	Aerodrome beacon	ALERFA ‡	Alert phase
ABT	About	ALR	Alerting (message type designator)
ABV	Above	ALRS	Alerting service
AC	Altocumulus	ALS	Approach lighting system
ACARS †	(to be pronounced "AY-CARS") Aircraft communication addressing and reporting system	ALT	Altitude
ACAS †	Airborne collision avoidance system	ALTN	Alternate or alternating (light alternates in colour)
ACC ‡	Area control centre or area control	ALTN	Alternate (aerodrome)
ACCID	Notification of an aircraft accident	AMA	Area minimum altitude
ACFT	Aircraft	AMD	Amend or amended (used to indicate amended meteorological message; message type designator)
ACK	Acknowledge	AMDT	Amendment (AIP Amendment)
ACL	Altimeter check location	AMS	Aeronautical mobile service
ACN	Aircraft classification number	AMSL	Above mean sea level
ACP	Acceptance (message type designator)	AMSS	Aeronautical mobile satellite service
ACPT	Accept or accepted	ANC	Aeronautical chart 1:500 000 (followed by name/ title and scale)
ACT	Active or activated or activity	ANCS	Aeronautical navigation chart - small scale (followed by name/title and scale)
AD	Aerodrome	ANS	Answer
ADA	Advisory area	AOC	Aerodrome obstacle chart
ADC	Aerodrome chart	AP	Airport
ADDN	Addition or additional	APAPI †	(to be pronounced "AY PAPI") Abbreviated precision approach path indicator
ADF ‡	Automatic direction-finding equipment	APCH	Approach
ADIZ †	(to be pronounced "AY-DIZ") Air defence identification zone	APDC	Aircraft parking / docking chart (followed by name/ title)
ADJ	Adjacent	APN	Apron
ADO	Aerodrome office (specify service)	APP	Approach control office or approach control or approach control service
ADR	Advisory route	APR	April
ADS*	The address (when this abbreviation is used to request a repetition, the question mark (IMI) precedes the abbreviation, e.g. IMI ADS) (to be used in AFS as a procedure signal)	APRX	Approximate or approximately
ADS-B‡	Automatic dependent surveillance - broadcast	APSG	After passing
ADS-C‡	Automatic dependent surveillance - contract	APU	Auxiliary power unit
ADSU	Automatic dependent surveillance unit	APV	Approve or approved or approval
ADVS	Advisory service	ARC	Area chart
ADZ	Advise	ARNG	Arrange
AES	Aircraft earth station	ARO	Air traffic services reporting office
AFIL	Flight plan filed in the air	ARP	Aerodrome reference point
AFIS	Aerodrome flight information service	ARP	Air - report (message type designator)
AFM	Yes or affirm or affirmative or that is correct	ARQ	Automatic error correction
AFS	Aeronautical fixed service	ARR	Arrive or arrival
AFT	After . . . (time or place)	ARR	Arrival (message type designator)
AFTN ‡	Aeronautical fixed telecommunication network	ARS	Special air - report (message type designator)
A/G	Air-to-ground	ARST	Arresting (specify (part of) aircraft arresting equipment)
AGA	Aerodromes, air routes and ground aids	AS	Altostratus
AGL	Above ground level	ASAP	As soon as possible
		ASC	Ascend to or ascending to
		ASDA	Accelerate - stop distance available
		ASE	Altimetry system error
		ASHTAM	Special series of NOTAM notifying, by means of a specific format, change in activity of volcano, a volcanic eruption and / or volcanic ash cloud that is of significance to aircraft operations
		ASPH	Asphalt

AT...	At (followed by time at which weather change is forecast to occur)	CCA	(or CCB, CCC...etc., in sequence) Correct meteorological message (message type designator)
ATA‡	Actual time of arrival		
ATC‡	Air traffic control (in general)	CCO	Continuous climb operations
ATCSMAC...	Air traffic control surveillance minimum altitude chart (followed by name / title)	CD	Candela
ATD‡	Actual time of departure	CDN	Coordination (message type designator)
ATFM	Air traffic flow management	CDO	Continuous descent operations
ATIS†	Automatic terminal information service	CDR	Conditional route
ATM	Air traffic management	CF	Change frequency to...
ATN	Aeronautical telecommunication network	CF	Course to a fix
ATP...	At... (time or place)	CFM*	Confirm or I confirm (to be used in AFS as a procedure signal)
ATS	Air traffic services	CGL	Circling guidance light(s)
ATTN	Attention	CH	Channel
AT - VASIS†	(to be pronounced "AY - TEE - VASIS")	CH#	This is a channel - continuity - check of transmission to permit comparison of your record of channel - sequence numbers of messages received on the channel (to be used in AFS as a procedure signal)
ATZ	Aerodrome traffic zone		
AUG	August		
AUTH	Authorized or authorization		
AUTO	Automatic		
AUW	All up weight	CHEM	Chemical
AUX	Auxiliary	CHG	Modification (message type designator)
AVBL	Available or availability	CI	Cirrus
AVG	Average	CIDIN†	Common ICAO data interchange network
AVGAS†	Aviation gasoline	CIV	Civil
AWOS	Automated weather observation system	CK	Check
AWTA	Advise at what table able	CL	Centre line
AWY	Airway	CLA	Clear type of ice formation
AZM	Azimuth	CLBR	Calibration
<b>B</b>		CLD	Cloud
B	Blue	CLG	Calling
BA	Braking action	CLIMB - OUT	Climb - out area
BARO -	(to be pronounced "BAA - RO - VEE - NAV")	CLR	Clear(s) or cleared to ... or clearance
VNAV†	Barometric vertical navigation	CLRD	Runway(s) cleared (used in METAR / SPECI)
BASE†	Cloud base	CLSD	Close or closed or closing
BCFG	Fog patches	CM	Centimetre
BCN	Beacon (aeronautical ground light)	CMB	Climb to or climbing to
BCST	Broadcast	CMPL	Completion or completed or complete
BDRY	Boundary	CNL	Cancel or cancelled
BECMG	Becoming	CNL	Flight plan cancellation (message type designator)
BFR	Before		
BKN	Broken	CNS	Communications, navigation and surveillance
BL...	Blowing (followed by DU = dust, SA = sand or SN = snow)	COM	Communications
		CONC	Concrete
BLDG	Building	COND	Condition
BLO	Below clouds	CONS	Continuous
BLW	Below...	CONST	Construction or constructed
BOMB	Bombing	CONT	Continue(s) or continued
BR	Mist	COOR	Coordinate or coordination
BRF	Short (used to indicate the type of approach desired or required)	COORD	Coordinates
		COP	Change - over - point
BRG	Bearing	COR	Correct or correction or corrected (used to indicate corrected meteorological message: message type designator)
BRKG	Braking		
BS	Commercial broadcasting station	COT	At the coast
BTL	Between layers	COV	Cover or covered or covering
BTN	Between	CPDLC‡	Controller - pilot data link communications
BUFR	Binary universal form for the representation of meteorological data	CPL	Current flight plan (message type designator)
<b>C</b>		CRC	Cyclic redundancy check
C	Centre (preceded by runway designation number to identify a parallel runway)	CRM	Collision risk model
C	Degrees Celsius (Centigrade)	CRZ	Cruise
CA	Course to an altitude	CS	Call sign
CAA	Civil Aviation Authority or Civil Aviation Administration	CS	Cirrostatus
		CTA	Control area
CAT	Category	CTAM	Climb to and maintain
CAT	Clear air turbulence	CTC	Contact
CAVOK†	(to be pronounced "KA - OH - KAY") Visibility, cloud and present weather better than prescribed values or conditions	CTL	Control
		CTN	Caution
		CTR	Control zone
CB‡	(to be pronounced "CEE BEE") Cumulonimbus	CU	Cumulus
CC	Cirrocumulus	CUF	Cumuliform
		CUST	Customs
		CVR	Cockpit voice recorder

CW	Continuous wave	EEE#	Error (to be used in AFS as a procedure signal)
CWY	Clearway	EET	Estimated elapsed time
<b>D</b>		EFC	Expect further clearance
D	Downward (tendency in RVR during previous 10 minutes)	EFIS†	(to be pronounced "EE - FIS") Electronic flight instrument system
D...	Danger area (followed by identification)	EGNOS†	(to be pronounced "EGG - NOS") EUROPEAN geostationary navigation overlay service
DA	Decision altitude		
D -ATIS†	(to be pronounced "DEE - ATIS") Data link automatic terminal information service	EHF	Extremely high frequency (30 000 to 300 000 MHZ)
DCD	Double channel duplex	ELBA†	Emergency location beacon - aircraft
DCKG	Docking	ELEV	Elevation
DCP	Datum crossing point	ELR	Extra long range
DCPC	Direct controller - pilot communications	ELT	Emergency locator transmitter
DCS	Double channel simplex	EM	Emission
DCT	Direct (in relation to flight plan clearances and type of approach)	EMBD	Embedded in a layer (to indicate cumulonimbus embedded in layers of other clouds)
DE*	From (used to precede the call sign of the calling station) (to be used in AFS as a procedure signal)	EMERG	Emergency
DEC	December	END	Stop - end (related to RVR)
DEG	Degrees	ENE	East north east
DEP	Depart or departure	ENG	Engine
DEP	Departure (message type designator)	ENR	En route
DEPO	Deposition	ENRC...	Enroute chart (followed by name / title)
DER	Departure end of the runway	EOBT	Estimated off - block time
DES	Descent to or descending to	EQN	Equatorial latitudes northern hemisphere
DEST	Destination	EQPT	Equipment
DESTRESFA	Distress phase	EQS	Equatorial latitudes southern hemisphere
†		ESE	East - south- east
DEV	Deviation or deviating	EST	Estimate or estimated or estimate (message type indicator)
DF	Direction finding	ETA*‡	Estimated time of arrival or estimating arrival
DFDR	Digital flight data recorder	ETD‡	Estimated time of departure or estimating departure
DFTI	Distance from touchdown indicator		
DH	Decision height	ETO	Estimated time over significant point
DIF	Diffuse	EUR RODEX	European regional OPMET data exchange
DIST	Distance	EV	Every
DIV	Divert or diverting	EVS	Enhanced vision system
DLA	Delay or delayed	EXC	Except
DLA	Delay (message type designator)	EXER	Exercises or exercising or exercise
DLIC	Data link initiation capability	EXP	Expect or expected or expecting
DLY	Daily	EXTD	Extend or extending
DME‡	Distance measuring equipment	<b>F</b>	
DNG	Danger or dangerous	F	Fixed
DOF	Date of flight	FA	Course from a fix to an altitude
DOM	Domestic	FAC	Facilities
DP	Dew point temperature	FAF	Final approach fix
DPT	Depth	FAL	Facilitation of international air transport
DR	Dead reckoning	FAP	Final approach point
DR...	Low drifting (followed by DU = dust, SA = sand or SN = snow)	FAS	Final approach segment
DRG	During	FATO	Final approach and take / off area
DS	Dust storm	FAX	Facsimile transmission
DSB	Double side-band	FBL	Light (used to indicate the intensity of weather phenomena, interference or static reports, e.g. FBL RA = light rain)
DTAM	Descend to and maintain		
DTG	Date - time group	FC	Funnel cloud (tornado or water spout)
DTHR	Displaced runway threshold	FCST	Forecast
DTRT	Deteriorate or deteriorating	FCT	Friction coefficient
DTW	Dual tandem wheels	FDPS	Flight data processing system
DU	Dust	FEB	February
DUC	Dense upper cloud	FEW	Few
DUPE#	This is a duplicate message (to be used in AFS as a procedure signal)	FG	Fog
DUR	Duration	FIC	Flight information centre
D - VOLMET	Data link VOLMET	FIR‡	Flight information region
DVOR	Doppler VOR	FIS	Flight information service
DW	Dual wheels	FISA	Automated flight information service
DZ	Drizzle	FL	Flight level
<b>E</b>		FLD	Field
E	East or eastern longitude	FLG	Flashing
EAT	Expected approach time	FLR	Flares
EB	Eastbound	FLT	Flight
EDA	Elevation differential area	FLTCK	Flight check
EDTO	Extended diversion time operations	FLUC	Fluctuating or fluctuation or fluctuated
		FLW	Follow(s) or following

FLY	Fly or flying	GRASS	Grass landing area
FM	Course from a fix to manual termination (used in navigation database coding)	GRIB	Processed meteorological data in the form of grid point values expressed in binary form (meteorological code)
FM	From	GS	Ground speed
FM...	From (followed by time at which weather change is forecast to begin)	GS	Small hail and / or snow pellets
FMC	Flight management computer	GUND	Geoid undulation
FMS‡	Flight management system	<b>H</b>	
FMU	Flow management unit	H	High pressure area or the centre of high pressure
FNA	Final approach	H...	Significant wave height (followed by figures in METAR / SPECI)
FPAP	Flight path alignment point	H24	Continuous day and night service
FPL	Filed flight plan (message type designator)	HA	Holding / racetrack to an altitude
FPM	Feet per minute	HAPI	Helicopter approach path indicator
FPR	Flight plan route	HBN	Hazard beacon
FR	Fuel remaining	HCH	Helicopter crossing height
FREQ	Frequency	HDF	High frequency direction - finding station
FRI	Friday	HDG	Heading
FRNG	Firing	HEL	Helicopter
FRONT†	Front (relating to weather)	HF‡	High frequency (3 000 to 30 000 KHZ)
FROST†	Frost (used in aerodrome warning)	HF	Holding / racetrack to a fix
FRQ	Frequent	HGT	Height or height above
FSL	Full stop landing	HJ	Sunrise to sunset
FSS	Flight service station	HLDG	Holding
FST	First	HLP	Heliport
FT	Feet (dimensional unit)	HLS	Helicopter landing site
FTE	Flight technical error	HM	Holding / racetrack to a manual termination
FTP	Fictitious threshold point	HN	Sunset to sunrise
FTT	Flight technical tolerance	HO	Service available to meet operational requirements
FU	Smoke		
FZ	Freezing	HOL	Holiday
FZDZ	Freezing drizzle	HOSP	Hospital aircraft
FZFG	Freezing fog	HPA	Hectopascal
FZRA	Freezing rain	HR	Hours
<b>G</b>		HRP	Heliport reference point
G	Green	HS	Service available during hours of scheduled operations
G...	Variations from the mean wind speed (gusts) (followed by figures in METAR / SPECI and TAF)	HSH	High latitudes southern hemisphere
GA	Go ahead, resume sending (to be used in AFS as a procedure signal)	HUD	Head - up display
GA	General aviation	HUM	Humanitarian
G/A	Ground - to - air	HURCN	Hurricane
G/A/G	Ground - to - air and air - to - ground	HVDF	High and very high frequency direction - finding stations (at the same location)
GAGAN†	GPS and geostationary earth orbit augmented navigation	HVY	Heavy
GAIN	Airspeed or headwind gain	HVY	Heavy (used to indicate the intensity of weather phenomena e.g. HVY RA = heavy rain)
GAMET	Area forecast for low - level flights	HX	No specific working hours
GARP	GBAS azimuth reference point	HYR	Higher
GBAS†	(to be pronounced "GEE - BAS") Ground - based augmentation system	HZ	Haze
GCA‡	Ground controlled approach system or ground controlled approach	HZ	Hertz (cycle per second)
GEN	General	<b>I</b>	
GEO	Geographic or true	IAC...	Instrument approach chart (followed by name / title)
GES	Ground earth station	IAF	Initial approach fix
GLD	Glider	IAO	In and out of clouds
GLONASS‡	(to pronounced "GLO - NAS") Global orbiting navigation satellite system	IAP	Instrument approach procedure
GLS‡	GBAS landing system	IAR	Intersection of air routes
GMC...	Ground movement chart (followed by name / title)	IAS	Indicated airspeed
GND	Ground	IBN	Identification beacon
GNDCK	Ground check	ICAO	International Civil Aviation Organization
GNSS‡	Global navigation satellite system	ICÉ	Icing
GOV	Government	ID	Identifier or identity
GP	Glide path	IDENT†	Identification
GPA	Glide path angle	IF	Intermediate approach fix
GPIP	Glide path intercept point	IFF	Identification friend / foe
GPS‡	Global positioning system	IFR‡	Instrument flight rules
GPU	Global power unit	IGA	International general aviation
GPWS‡	Ground proximity warning system	ILS‡	Instrument landing system
GR	Hail	IM	Inner marker
GRAS†	(to be pronounced "GRASS") Ground - based regional augmentation system	IMC‡	Instrument meteorological conditions
		IMG	Immigration



IMI*	Interrogation sign (question mark) (to be used in AFS as a procedure signal)	LORAN†	LORAN (long range air navigation system)
IMPR	Improve or improving	LOSS	Airspeed or headwind loss
IMT	Immediate or immediately	LPV	Localizer performance with vertical guidance
INA	Initial approach	LR	The last message received by me was... (to be used in AFS as a procedure signal)
INBD	Inbound	LRG	Long range
INC	In cloud	LS	The last message sent by me was... (to be used in AFS as a procedure signal)
INCERFA†	Uncertainty phase	LTA	Lower control area
INCORP	Incorporated	LTD	Limited
INFO†	Information	LTP	Landing threshold point
INOP	Inoperative	LV	Light and variable (relating to wind)
INP	If not possible	LVE	Leave or leaving
INPR	In progress	LVL	Level
INS	Inertial navigation system	LVP	Low visibility procedures
INSTL	Install or installed or installation	LYR	Layer or layered
INSTR	Instrument	<b>M</b>	
INT	Intersection	...M	Metres (preceded by figures)
INTL	International	M...	Mach number (followed by figures)
INTRG	Interrogator	M...	Minimum value of runway visual range (followed by figures in METAR / SPECI)
INTRP	Interrupt or interruption or interrupted	MAA	Maximum authorized altitude
INTSF	Intensify or intensifying	MAG	Magnetic
INTST	Intensity	MAHF	Missed approach holding fix
IR	Ice on runway	MAINT	Maintenance
IRS	Inertial reference system	MAP	Aeronautical maps and charts
ISA	International standard atmosphere	MAPT	Missed approach point
ISB	Independent sideband	MAR	At sea
ISOL	Isolated	MAR	March
<b>J</b>		MATF	Missed approach turning fix
JAN	January	MAX	Maximum
JTST	Jet stream	MAY	May
JUL	July	MBST	Microburst
JUN	June	MCA	Minimum crossing altitude
<b>K</b>		MCW	Modulated continuous wave
KG	Kilograms	MDA	Minimum descent altitude
KHZ	Kilohertz	MDF	Medium frequency direction - finding station
KIAS	Knots indicated airspeed	MDH	Minimum descent height
KM	Kilometres	MEA	Minimum en - route altitude
KMH	Kilometres per hour	MEDEVAC	Medical evacuation flight
KPA	Kilopascal	MEHT	Minimum eye height over threshold (for visual approach slope indicator systems)
KT	Knots	MET†	Meteorological or meteorology
KW	Kilowatts	METAR†	Aerodrome routine meteorological report (in meteorological code)
<b>L</b>		MET	Local routine meteorological report (in abbreviated plain language)
...L	Left (preceded by runway designation number to identify a parallel runway)	REPORT	Medium frequency (300 to 3 000 KHZ)
L	Litre	MF	Minimum holding altitude
L	Locator	MHA	Medium and high frequency direction - finding stations (at same location MHVDE Medium, high and very high frequency direction - finding stations)
L	Low pressure area or the centre of low pressure	MHDF	Megahertz
LAM	Logical acknowledgement (message type indicator)	MHZ	Mid - point (related to RVR)
LAN	Inland	MID	Shallow fog
LAT	Latitude	MIFG	Military
LCA	Local or locally or location or located	MIL	Minutes
LDA	Landing distance available	MIN*	Missing... (transmission identification) (to be used in AFS as a procedure signal)
LDAH	Landing distance available, helicopter	MIS	Marker radio beacon
LDG	Landing	MKR	Microwave landing system
LDI	Landing direction indicator	MLS‡	Middle marker
LEN	Length	MM	Middle latitudes northern hemisphere
LF	Low frequency (30 to 300 KHZ)	MNH	Minimum
LGT	Light or lighting	MNM	Minimum navigation performance specifications
LGTD	Lighted	MNPS	Monitor or monitoring or monitored
LIH	Light intensity high	MNT	Maintain
LIL	Light intensity low	MNTN	Military operating area
LIM	Light intensity medium	MOA	Minimum obstacle clearance (required)
Line	Line (used in SIGMET)	MOC	Minimum obstacle clearance altitude
LM	Locator, middle	MOCA	
LMT	Local mean time		
LNAV†	(to be pronounced "EL - NAV") Lateral navigation		
LNG	Long (used to indicate the type of approach desired or required)		
LO	Locator, outer		
LOC	Localizer		
LONG	Longitude		

MOD	Moderate (used to indicate the intensity of weather phenomena, interference or static reports e.g. MODRA = moderate rain)	NOTAM†	Notice distribution by means of telecommunication containing information concerning the establishment, condition or change in any aeronautical facility, service, procedure or hazard, the timely knowledge of which is essential to personnel concerned with flight operations
MON	Above mountains		
MON	Monday		
MOPS†	Minimum operational performance standards		
MOTNE	Meteorological Operational Telecommunications Network Europe	NOTAMC	Cancelling NOTAM
MOV	Move or moving or movement	NOTAMN	New NOTAM
MPS	Metres per second	NOTAMR	Replacing NOTAM
MRA	Minimum reception altitude	NOV	November
MRG	Medium range	NOZ‡	Normal operating zone
MRP	ATS / MET reporting point	NPA	Non precision approach
MS	Minus	NR	Number
MSA	Minimum sector altitude	NRH	No reply heard
MSAS†	(to be pronounced "EM -SAS") Multifunctional transport satellite (MTSAT) satellite - based augmentation system	NS	Nimbostratus
MSAW	Minimum safe altitude warning	NSC	Nil significant cloud
MSG	Message	NSE	Navigation system error
MSH	Middle latitudes southern hemisphere	NSW	Nil significant weather
MSL	Mean sea level	NTL	National
MSR#	Message... (transmission identification) has been misrouted (to used in AFS as a procedure signal)	NTZ‡	No transgression zone
MSSR	Monopulse secondary surveillance radar	NW	North - west
MT	Mountain	NWB	North - westbound
MTOM	Maximum take - off mass	NXT	Next
MTU	Metric units	<b>O</b>	
MTW	Mountain waves	OAC	Oceanic area control centre
MVDF	Medium and very high frequency direction - finding stations (at the same location)	OAS	Obstacle assessment surface
MWO	Meteorological watch office	OBS	Observe or observed or observation
MX	Mixed type of ice formation (white and clear)	OBSC	Obscure or obscured or obscuring
<b>N</b>		OBST	Obstacle
N	No distinct tendency (in RVR during previous 10 minutes)	OCA	Oceanic clearance altitude
N	North or northern latitude	OCA	Obstacle control area
NADP	Noise abatement departure procedure	OCC	Occulting (light)
NASC†	National AIS system centre	OCH	Obstacle clearance height
NAT	North Atlantic	OCNL	Occasional or occasionally
NAV	Navigation	OCS	Obstacle clearance surface
NAVAID	Navigation aid	OCT	October
NB	Northbound	OFZ	Obstacle free zone
NBFR	Not before	OGN	Originate (to be used in AFS as a procedure signal)
NC	No change	OHD	Overhead
NCD	No cloud detected (used in automated METAR / SPECI)	OIS	Obstacle identification surface
NBD‡	Non - directional radio beacon	OK	We agree or It is correct (to be used in AFS as a procedure signal)
NDV	No directional variations available (used in automated METAR / SPECI)	OLD†	On - line data interchange
NE	North - east	OM	Outer marker
NEB	North - eastbound	OPA	Opaque, white type of ice formation
NEG	No or negative or permission not granted or that is not correct	OPC	The control indicated is operational control
NGT	Night	OPMET†	Operational meteorological (information)
NIL*†	None or I have nothing to send to you	OPN	Open or opening or opened
NM	Nautical miles	OPR	Operator or operate or operative or operating or operational
NML	Normal	OPS†	Operations
NN	No name, unnamed	O/R	On request
NNE	North - north - east	ORD	Order
NNW	North - north - west	OSV	Ocean station vessel
NO	No (negative) (to used in AFS as a procedure signal)	OTP	On top
NOF	International NOTAM office	OTS	Organized track system
NONSTD	Non - standard	OUBD	Outbound
NOSIG†	No significant change (used in trend - type landing forecasts)	OVC	Overcast
		<b>P</b>	
		P...	Maximum value of wind speed or runway visual range (followed by figures in METAR / SPECI and TAF)
		P...	Prohibited area (followed by identification)
		PA	Precision approach
		PALS	Precision approach lighting system (specify category)
		PANS	Procedures for air navigation services
		PAPI†	Precision approach path indicator
		PAR‡	Precision approach radar
		PARL	Parallel

PATC...	Precision approach terrain chart (followed by name / title)	QTF	Will you give me the position of my station according to the bearings taken by the D / F stations which you control? or the position of your station the according to bearings taken by the D / F station I control was...latitude...logitude (or other indication of position), class...at...hours (to be used in radio telegraphy as a Q code)
PAX	Passenger(s)		
PBC	Performance - based communication		
PBN	Performance - based navigation		
PBS	Performance - based surveillance		
PCD	Proceed or proceeding		
PCL	Pilot - controlled lighting	QUAD	Quadrant
PCN	Pavement classification number	QUJ	Will you indicate the TRUE track to reach you? Or the TRUE track to reach me is...degrees at...hours (to be used in radio telegraphy as a Q code)
PCT	Per cent		
PCD‡	Pre - departure clearance		
PDG	Procedure design gradient	R	
PER	Performance	...R	Right (preceded by runway designation number to identify a parallel runway)
PERM	Permanent		
PIB	Pre - flight information bulletin	R	Rate of turn
PJE	Parachute jumping exercise	R	Red
PL	Ice pellets	R...	Radial from VOR (followed by figures)
PLA	Practice low approach	R...	Restricted area (followed by identification)
PLVL	Present level	R...	Runway (followed by figures in METAR / SPECI)
PN	Prior notice required	R*	Received (acknowledgement of receipt) (to be used in AFS as a procedure signal)
PNR	Point of no return		
PO	Dust / sand whirls (dust devils)	RA	Rain
POB	Persons on board	RA	Resolution advisory
POSS	Possible	RAC	Rules of the air and air traffic services
PPI	Plan position indicator	RAG	Ragged
PPR	Prior permission required	RAG	Runway arresting gear
PPSN	Present position	RAI	Runway alignment indicator
PRFG	Aerodrome partially covered by fog	RAIM†	Receiver autonomous integrity monitoring
PRI	Primary	RASC†	Regional AIS system centre
PRKG	Parking	RASS	Remote altimeter setting source
PROB†	Probability	RB	Rescue boat
PROC	Procedure	RCA	Reach cruising altitude
PROP	Propeller	RCC	Rescue coordination centre
PROV	Provisional	RCF	Radio communication failure (message type designator)
PRP	Point - in - space reference point		
PS	Plus	RCH	Reach or reaching
PSG	Passing	RCL	Runway centre line
PSN	Position	RCLL	Runway centre line light(s)
PSP	Pierced steel plank	RCLR	Recleared
PSR‡	Primary surveillance radar	RCP‡	Required communication performance
PSYS	Pressure systems	RDH	Reference datum height (for ILS)
PTN	Procedure turn	RDL	Radial
PTS	Polar track structure	RDO	Radio
PWR	Power	RDOACT	Radioactive
Q		RE	Recent (used to qualify weather phenomena, e.g. RERA = recent rain)
QDL	Do you intend to ask me for a series of bearings? Or I intend to ask you for a series of bearings (to be used in radio telegraphy as a Q code)	REC	Receive or receiver
		REDL	Runway edge light(s)
QDM‡	Magnetic heading (zero wind)	REF	Reference to...or refer to...
QDR	Magnetic bearing	REG	Registration
QFE‡	Atmospheric pressure at aerodrome elevation (or at runway threshold)	RENL	Runway end light(s)
		REP	Report or reporting or reporting point
QFU	Magnetic orientation on runway	REQ	Request or requested
QGE	What is my distance to your station? Or your distance to my station is (distance figures and units) (to be used in radio telegraphy as a Q code)	RERTE	Re - route
		RESA	Runway end safety area
QJH	Shall I run my test tape / a test sentence? Or run your test tape / a test sentence (to be used in AFS as a Q code)	RF	Constant radius arc to a fix
		RFFS	Rescue and fire fighting services
		RG	Range (lights)
QNH‡	Altimeter sub - scale setting to obtain elevation when on the ground	RHC	Right - hand circuit
		RIF	Re-clearance in flight
QSP	Will you relay to...free of charge? Or I will relay to... free of charge (to be used in AFS as a Q code)	RIME†	Rime (used in aerodrome warnings)
		RL	Report leaving
QTA	Shall I cancel telegram number...? Or cancel telegram number...(to be used in AFS as a Q code)	RLA	Relay to
		RLCE	Request level change en - route
		RLLS	Runway lead - in lighting system
QTE	True bearing	RLNA	Request level not available
		RMK	Remark
		RNAV†	(to be pronounced "AR - NAV") Area navigation
		RNG	Radio range
		RNP‡	Required navigation performance
		ROBEX†	Regional OPMET bulletin exchange (scheme)
		ROC	Rate of climb

ROD	Rate of descent	SEV	Severe (used e.g. to qualify icing and turbulence reports)
RON	Receiving only	SFC	Surface
RPDS	Reference path data selector	SG	Snow grains
RPI‡	Radar position indicator	SGL	Signal
RPL	Repetitive flight plan	SH...	Showers (followed by RA = rain, SN = snow, PL = ice pellets, GR = hail, GS = small hail and / or snow pellets or combination of thereof e.g. SHRASN = Showers of rain and snow)
RPLC	Replace or replaced	SHF	Super high frequency (3000 to 30000 MHZ)
RPS	Radar position symbol	SI	International system of units
RPT*	Repeat or I repeat (to be used in AFS as a procedure signal)	SID†	Standard instrument departure
RQ-*	Request (to be used in AFS as a procedure signal)	SIF	Selective identification feature
RQMNT	Requirements	SIG	Significant
RQP	Requested flight plan (message type designator)	SIGMET†	Information concerning en - route weather and other phenomena in the atmosphere that may be affect the safety of aircraft operations
RQS	Request supplementary flight plan (message type designator)	SIMUL	Simultaneous or simultaneously
RR	Report reaching	SIWL	Single isolated wheel load
RRA	(or RRB,RRC,...etc., in sequence) Delayed meteorological message (message type designator)	SKED	Schedule or scheduled
RSC	Rescue sub - centre	SLP	Speed limiting point
RSCD	Runway surface condition	SLW	Slow
RSP	Responder beacon	SMC	Surface movement control
RSP‡	Required surveillance performance	SMR	Surface movement radar
RSR	En - route surveillance radar	SN	Snow
RSS	Root sum square	SNOCLO	Aerodrome closed due to snow (used in METAR / SPECI)
RTD	Delayed (used to indicate delayed meteorological message; message type designator)	SNOWTAM†	A special series of NOTAM given in a standard format providing a surface condition report notifying the presence or cessation of hazardous conditions due to snow, ice, slush, frost, standing water or water associated with snow, slush, ice or frost on the movement area
RTE	Route	SOC	Start of climb
RTF	Radio telephone	SPECI†	Aerodrome special meteorological report (in meteorological code)
RTG	Radio telegraph	SPECIAL†	Local special meteorological report ( in abbreviated plain language)
RTHL	Runway threshold light(s)	SPI	Special position indicator
RTN	Return or returned or returning	SPL	Supplementary flight plan (message type designator)
RTODAH	Rejected take - off distance available, helicopter	SPOC	SAR point of contact
RTS	Return to service	SPOT†	Spot wind
RTT	Radio teletype writer	SQ	Squall
RTZL	Runway touchdown zone light(s)	SQL	Squall line
RUT	Standard regional route transmitting frequencies	SR	Sunrise
RV	Rescue vessel	SRA	Surveillance radar approach
RVA	Radar vectoring area	SRE	Surveillance radar element of precision approach radar system
RVR‡	Runway visual range	SRG	Short range
RVSM‡	Reduced vertical separation minimum (300 M (1000 FT) between FL 290 and FL 410)	SRR	Search and rescue region
RWY	Runway	SRY	Secondary
<b>S</b>		SS	Sandstorm
S...	State of the sea (followed by figures in METAR / SPECI)	SS	Sunset
S	South or southern latitude	SSB	Single sideband
SA	Sand	SSE	South - south east
SALS	Simple approach lighting system	SSR‡	Secondary surveillance radar
SAN	Sanitary	SST	Supersonic transport
SAR	Search and rescue	SSW	South - south west
SARPS	Standard and Recommended Practices (ICAO)	ST	Stratus
SAT	Saturday	STA	Straight - in approach
SATCOM†	Satellite communication	STAR†	Standard instrument arrival
SATVOICE†	Satellite voice communication	STD	Standard
SB	Southbound	STF	Stratiform
SBAS†	(to be pronounced "ESS - BAS") Satellite - based augmentation system	STN	Station
SC	Stratocumulus	STNR	Stationary
SCT	Scattered	STOL	Short take - off and landing
SD	Standard deviation	STS	Status
SDBY	Standby	STWL	Stopway light(s)
SDF	Step down fix	SUBJ	Subject to
SE	South - east	SUN	Sunday
SEA	Sea (used in connection with sea - surface temperature and state of the sea)	SUP	Supplement
SEB	South - eastbound		
SEC	Seconds		
SECN	Section		
SECT	Sector		
SELCAL†	Selective calling system		
SEP	September		
SER	Service or servicing or served		









SUPPS	Regional supplementary procedures	TS...	Thunderstorm (followed by RA = rain, SN = snow, PL = ice pellets, GR = hail, GS = small hail and / or snow pellets or combination thereof e.g. TSRASN = thunderstorm with rain and snow)
SVC	Service messages	TSUNAMI†	Tsunami (used in aerodrome warnings)
SVCBL	Serviceable	TT	Teletype writer
SW	South - west	TUE	Tuesday
SWB	South - westbound	TURB	Turbulence
SWX	Space weather	T-VASIS†	(to be pronounced "TEE - VASIS") T visual approach slope indicator system
SWXC	Space weather centre	TVOR	Terminal VOR
SWY	Stopway	TWR	Aerodrome control tower or aerodrome control
<b>T</b>		TWY	Taxiway
T	Temperature	TX...	Maximum temperature (followed by figures in TAF)
...T	True (preceded by bearing to indicate reference to True North)	TXL	Taxilane
TA	Traffic advisory	TXT*	Text (when the abbreviation is used to request a repetition, the question mark (IMI) precedes the abbreviation, e.g. IMI TXT) (to be used in AFS as a procedure signal)
TA	Transition altitude	TYP	Type of aircraft
TAA	Terminal arrival altitude	TYPH	Typhoon
TACAN†	UHF tactical air navigation aid	<b>U</b>	
TAF†	Aerodrome forecast (in meteorological code)	U	Upward (tendency in RVR during previous 10 minutes)
TA/H	Turn at an altitude / height	UA	Unmanned aircraft
TAIL†	Tail wind	UAB...	Until advised by...
TAR	Terminal area surveillance radar	UAC	Upper area control centre
TAS	True airspeed	UAR	Upper air route
TAX	Taxiing or taxi	UAS	Unmanned aircraft system
TC	Tropical cyclone	UDF	Ultra high frequency direction - finding station
TCAC	Tropical cyclone advisory centre	UFN	Until further notice
TCAS RA†	(to be pronounced (" TEE -CAST - AR - AY ")) Traffic alert and collision avoidance system resolution advisory	UHDT	Unable higher due traffic
TCH	Threshold crossing height	UHF‡	Ultra high frequency (300 to 3000 MHZ)
TCU	Towering cumulus	UIC	Upper information centre
TDO	Tornado	UIR‡	Upper flight information region
TDZ	Touchdown zone	ULM	Ultra light motorized aircraft
TECR	Technical reason	ULR	Ultra long range
TEL	Telephone	UNA	Unable
TEMPO†	Temporary or temporarily	UNAP	Unable to approve
TF	Track to fix	UNL	Unlimited
TFC	Traffic	UNREL	Unreliable
TGL	Touch - and - go landing	UP	Unidentified precipitation (used in automated METAR / SPECI)
TGS	Taxiing guidance system	U/S	Unserviceable
THR	Threshold	UTA	Upper control area
THRU	Through	UTC‡	Coordinated Universal Time
THU	Thursday	<b>V</b>	
TIBA†	Traffic information broadcast by aircraft	...V...	Variations from the mean wind direction (preceded and followed by figures in METAR / SPRECI, e.g. 350V070)
TIL†	Until	VA	Heading to an altitude
TIP	Until past...(place)	VA	Volcanic ash
TKOF	Take - off	VAAC	Volcanic ash advisory centre
TL...	Till (followed by which weather change is forecast to end)	VAC...	Visual approach chart (followed by name / title)
TLOF	Touchdown and lift - off area	VAL	In valleys
TMA‡	Terminal control area	VAN	Runway control van
TN...	Minimum temperature (followed by figures in TAF)	VAR	Magnetic variation
TNA	Turn altitude	VAR	Visual - aural radio range
TNH	Turn height	VASIS	Visual approach slope indicator system
TO...	To...(place)	VC...	Vicinity of the aerodrome (followed by FG = fog, FC = funnel cloud, SH = shower, PO = dust / sand whirls, BLDU = blowing dust, BLSA = blowing sand or BLSN = blowing snow, DS = duststorm, SS = sandstorm, TS = thunderstorm or VA = volcanic ash, e.g.VCFG = vicinity fog)
TOC	Top of climb	VCY	Vicinity
TADA	Take - off distance available	VDF	Very high frequency direction - finding station
TODAH	Take - off distance available, helicopter	VER	Vertical
TOP†	Cloud top	VFR‡	Visual flight rules
TORA	Take - off run available	VHF‡	Very high frequency (30 to 300 MHZ)
TOX	Toxic	VI	Heading to intercept
TP	Turning point		
TR	Track		
TRA	Temporary reserved airspace		
TRANS	Transmit or transmitter		
TREND†	Trend forecast		
TRG	Training		
TRL	Transition level		
TROP	Tropopause		
TS	Thunderstorm (in aerodrome reports and forecasts, TS used alone means thunder heard but no precipitation at the aerodrome)		

VIP‡	Very important person	† When radio telephony is used, the abbreviations and terms are transmitted as spoken words.
VIS	Visibility	
VLF	Very low frequency (3 to 30 KHZ)	
VLR	Very long range	‡ When radio telephony is used, the abbreviations and terms are transmitted using the individual letters in non-phonetic form.
VM	Heading to a manual termination	
VMC	Visual meteorological conditions	
VNAV†	(to be pronounced "VEE - NAV") Vertical navigation	
VOL...	Volume (followed by I, II...)	
VOLMET†	Meteorological information for aircraft in flight	
VOR‡	VHF omnidirectional radio range	
VORTAC‡	VOR and TACAN combination	
VOT	VOR airborne equipment test facility	
VPA	Vertical path angle	
VPT	Visual manoeuvre with prescribed track	
VRB	Variable	
VSA	By visual reference to the ground	
VSP	Vertical speed	
VTF	Vector to final	
VTOL	Vertical take - off and landing	
VV...	Vertical visibility (followed by figures in METAR / SPECI and TAF)	
<b>W</b>		
W	West or western longitude	
W	White	
W...	Sea - surface temperature (followed by figures in METAR / SPECI)	
WAAS†	Wide area augmentation system	
WAC...	World Aeronautical Chart - ICAO 1:1000000 (followed by name / title)	
WAFC	World area forecast centre	
WB	Westbound	
WBAR	Wing bar lights	
WDI	Wind direction indicator	
WDSPR	Widespread	
WED	Wednesday	
WEF	With effect from or effective from	
WGS - 84	World Geodetic System - 1984	
WI	Within	
WID	Width or wide	
WIE	With immediate effect or effective immediately	
WILCO†	Will comply	
WIND	Wind	
WIP	Work in progress	
WKN	Weaken or weakening	
WNW	West - north - west	
WO	Without	
WPT	Way - point	
WRNG	Warning	
WS	Wind shear	
WSPD	Wind speed	
WSW	West - south - west	
WT	Weight	
WTSPT	Waterspout	
WWW	Worldwide web	
WX	Weather	
WXR	Weather radar	
<b>X</b>		
X	Cross	
XBAR	Crossbar (of approach lighting system)	
XNG	Crossing	
XS	Atmospherics	
<b>Y</b>		
Y	Yellow	
YCZ	Yellow caution zone (runway lighting)	
YES*	Yes (affirmative) (to be used in AFS as a procedure signal)	
YR	Your	
<b>Z</b>		
Z	Coordinated Universal Time (in meteorological messages)	



GEN 2.3 CHART SYMBOLS

2.3.1. Aerodromes



2.3.1.1 Charts other than approach charts

Civil (land)	
Civil (water)	
Joint civil and military (land)	
Joint civil and military (water)	
Military (land)	
Military (water)	
Emergency aerodrome or aerodrome with no facilities	
Sheltered anchorage	
Heliport	

2.3.1.2 Approach Charts

The aerodrome on which the procedure is based	
Aerodromes affecting the traffic pattern on the aerodrome on which the procedure is based	

2.3.1.3 Aerodrome Charts

Hard surface runway	
Unpaved runway	
Stopway SWY	

2.3.2. Aerodrome data

Elevation above sea level	74
Minimum lighting	L
Runway hard surface	H
Length of longest runway in hundreds of meters	14

**Note:** A dash ( - ) is inserted where L or H does not apply



2.3.3. Radio facilities

Non - directional radio beacon (NDB)	
Distance - measuring equipment (DME)	
Co - located VOR and DME facilities	
VHF omni - directional radio range (VOR)	

2.3.4. Abbreviations

Aerodrome Control Tower	TWR
Instrument Landing System	ILS
Locator beacon	L
Meteorological service	MET
Approach control service	APP
Area control center	ACC
Flight information service	FIS
Flight information region	FIR
Terminal control area	TMA
Control area	CTA
Upper control area	UTA



Example of combination of Airport facilities

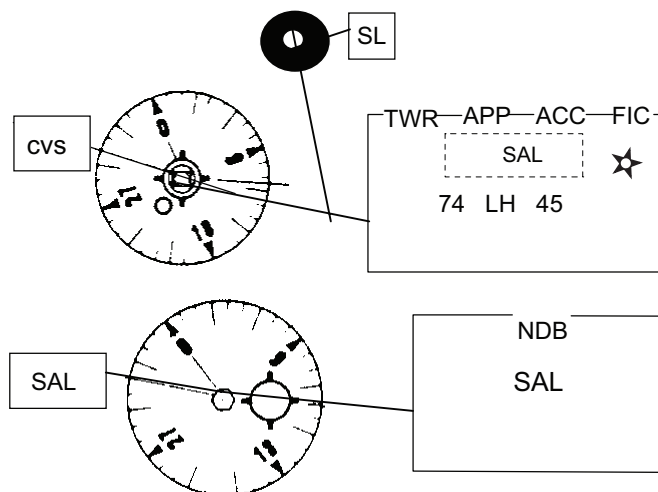

2.3.5. Aerodrome Installations and Lights

Aerodrome reference point (ARP)	
Taxiways and parking areas	
Control tower	Control Tower
Point light	
Barrette	
Obstacle light	
Aeronautical ground light	
Wind direction indicator (lighted)	
Wind direction indicator (unlighted)	
Landing direction indicator (lighted)	
Landing direction indicator (unlighted)	
Marine light	Occ W R G //

(Visibility range of marine lights are shown in nautical miles). Marine alternating lights are red and white unless otherwise indicated. Marine lights are white unless colours are stated.	
Fixed	F
Flashing	Fl
Occulting	Occ
Alternating	Alt
Group	Gp
Red	R
White	W
Blue	B
Green	G
Sector	SEC
Second	sec

2.3.6. Miscellaneous

Highest elevation on chart	• 3365
Obstacles	Lighted 
Group obstacles <i>Note: Numerals in italics indicate elevation of top of obstacle above sea level. Upright numerals in parentheses indicate height above specified datum.</i>	
Restricted airspace (prohibited, restricted or danger areas)	
Common boundary of two areas	
Air defence identification zone (ADZ)	<b>ADIZ</b> 
Transmission line or overhead cable	-T-T-
Isogonal	
Boundary of flight information region (FIR)	
Control area and airway (AWY)	
Control zone (CTR)	

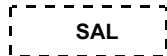
Reporting point (compulsory and non - compulsory) and ATS / MET	
Customs aerodrome	

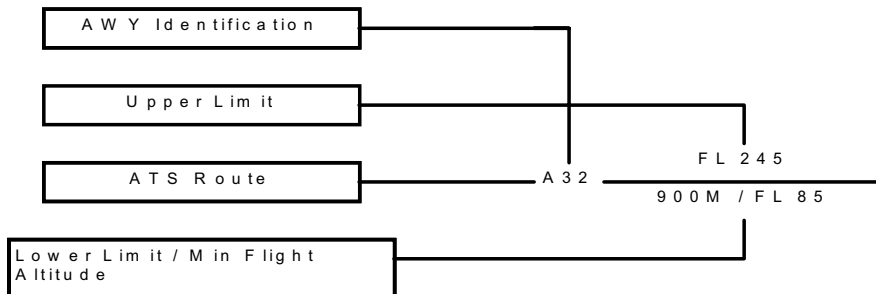
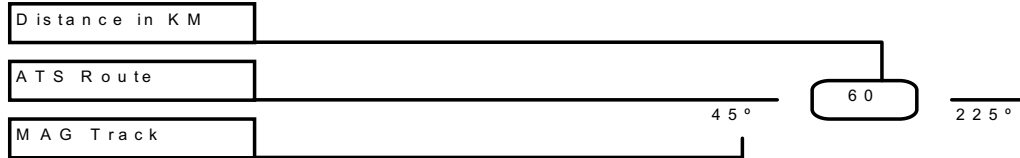

**2.3.7. Topographical symbols**

NIL

**INTENTIONALLY LEFT BLANK**

## GEN 2.4 LOCATION INDICATORS

The location indicators marked with an asterisk (\*) cannot be used in the address component of AFS messages.

1. ENCODE		2. DECODE	
Location	Indicator	Indicator	Location
FOGO ISLAND / SAO FILIPE*	GVSF	GVAC	SAL ISLAND / AMILCAR CABRAL
MAIO ISLAND / MAIO*	GVMA	GVBA	RABIL / ARISTIDES PEREIRA
PRAIA / NELSON MANDELA	GVNP	GVMA	MAIO ISLAND / MAIO*
RABIL / ARISTIDES PEREIRA	GVBA	GVNP	PRAIA / NELSON MANDELA
SAL ISLAND / AMILCAR CABRAL	GVAC	<b>GVSC</b>	SAL OCENIC FIR
SAL OCEANIC UIR	<b>GVSC</b>	<b>GVSC</b>	SAL OCEANIC UIR
SAL OCENIC FIR	<b>GVSC</b>	GVSF	FOGO ISLAND / SAO FILIPE*
SAO NICOLAU ISLAND / PREGUICA*	GVSN	GVSN	SAO NICOLAU ISLAND / PREGUICA*
SAO PEDRO / CESARIA EVORA	GVSV	GVSV	SAO PEDRO / CESARIA EVORA

**INTENTIONALLY LEFT BLANK**

GEN 2.5 LIST OF RADIO NAVIGATION AIDS

<i>ID</i>	<i>Station name</i>	<i>Aid</i>	<i>Purpose</i> <i>A=Aerodrome</i> <i>E=Enroute</i> <i>AE=Both</i>	<i>Station name</i>	<i>ID</i>	<i>Aid</i>	<i>Purpose</i> <i>A=Aerodrome</i> <i>E=Enroute</i> <i>AE=Both</i>
BVT	BOA VISTA / RABIL	NDB	AE	BOA VISTA / RABIL	BVT	NDB	AE
CVS	SAL / AMILCAR CABRAL	VOR/DME	AE	PRAIA	PRA	NDB	A
NCL	SAO NICOLAU	L	A	PRAIA	SNT	VOR/DME	AE
PRA	PRAIA	NDB	A	SAL / AMILCAR CABRAL	CVS	VOR/DME	AE
SAL	SAL / AMILCAR CABRAL	NDB	A	SAL / AMILCAR CABRAL	SAL	NDB	A
SL	SAL ILS	ILS	A	SAL ILS	SL	ILS	A
SNT	PRAIA	VOR/DME	AE	SAO NICOLAU	NCL	L	A
SP	SAO VICENTE	LOC	A	SAO VICENTE	SVT	NDB	E
SVT	SAO VICENTE	NDB	E	SAO VICENTE	SP	LOC	A

**INTENTIONALLY LEFT BLANK**



**GEN 2.6 CONVERSION OF UNITS OF MEASUREMENT**

Tables for conversions or alternately conversions formulae between:

<i>NM to KM</i> 1 NM = 1.852 KM		<i>KM to NM</i> 1 KM = 0.54 NM		<i>FT to M</i> 1 FT = 0.3048 M		<i>M to FT</i> 1 M = 3.281 FT	
<i>NM</i>	<i>KM</i>	<i>KM</i>	<i>NM</i>	<i>FT</i>	<i>M</i>	<i>M</i>	<i>FT</i>
0.1	0.185	0.1	0.05	1	0.305	1	3.28
0.2	0.370	0.2	0.11	2	0.610	2	6.56
0.3	0.556	0.3	0.16	3	0.914	3	9.84
0.4	0.741	0.4	0.22	4	1.219	4	13.12
0.5	0.926	0.5	0.27	5	1.524	5	16.40
0.6	1.111	0.6	0.32	6	1.829	6	19.69
0.7	1.296	0.7	0.38	7	2.134	7	22.97
0.8	1.482	0.8	0.43	8	2.438	8	26.25
0.9	1.667	0.9	0.49	9	2.743	9	29.53
1	1.852	1	0.54	10	3.048	10	32.81
2	3.704	2	1.08	20	6.096	20	65.62
3	5.556	3	1.62	30	9.144	30	98.43
4	7.408	4	2.16	40	12.192	40	131.23
5	9.260	5	2.70	50	15.240	50	164.04
6	11.112	6	3.24	60	18.288	60	196.85
7	12.964	7	3.78	70	21.336	70	229.66
8	14.816	8	4.32	80	24.384	80	262.47
9	16.668	9	4.86	90	27.432	90	295.28
10	18.520	10	5.40	100	30.480	100	328.08
20	37.040	20	10.80	200	60.960	200	656.17
30	55.560	30	16.20	300	91.440	300	984.25
40	74.080	40	21.60	400	121.920	400	1 312.34
50	92.600	50	27.00	500	152.400	500	1 640.42
60	111.120	60	32.40	600	182.880	600	1 968.50
70	129.640	70	37.80	700	213.360	700	2 296.59
80	148.160	80	43.20	800	243.840	800	2 624.67
90	166.680	90	48.60	900	274.320	900	2 952.76
100	185.200	100	54.00	1 000	304.800	1 000	3 280.84
200	370.400	200	107.99	2 000	609.600	2 000	6 561.68
300	555.600	300	161.99	3 000	914.400	3 000	9 842.52
400	740.800	400	215.98	4 000	1 219.200	4 000	13 123.36
500	926.000	500	269.98	5 000	1 524.000	5 000	16 404.20
				6 000	1 828.800		
				7 000	2 133.600		
				8 000	2 438.400		
				9 000	2 743.200		
				10 000	3 048.000		

*From decimal minutes of an arc to seconds of an arc*

<i>MIN</i>	<i>SEC</i>	<i>MIN</i>	<i>SEC</i>	<i>MIN</i>	<i>SEC</i>	<i>MIN</i>	<i>SEC</i>
0.01	0.6	0.26	15.6	0.51	30.6	0.76	45.6
0.02	1.2	0.27	16.2	0.52	31.2	0.77	46.2
0.03	1.8	0.28	16.8	0.53	31.8	0.78	46.8
0.04	2.4	0.29	17.4	0.54	32.4	0.79	47.4
0.05	3.0	0.30	18.0	0.55	33.0	0.80	48.0

*From decimal minutes of an arc to seconds of an arc*

MIN	SEC	MIN	SEC	MIN	SEC	MIN	SEC
0.06	3.6	0.31	18.6	0.56	33.6	0.81	48.6
0.07	4.2	0.32	19.2	0.57	34.2	0.82	49.2
0.08	4.8	0.33	19.8	0.58	34.8	0.83	49.8
0.09	5.4	0.34	20.4	0.59	35.4	0.84	50.4
0.10	6.0	0.35	21.0	0.60	36.0	0.85	51.0
0.11	6.6	0.36	21.6	0.61	36.6	0.86	51.6
0.12	7.2	0.37	22.2	0.62	37.2	0.87	52.2
0.13	7.8	0.38	22.8	0.63	37.8	0.88	52.8
0.14	8.4	0.39	23.4	0.64	38.4	0.89	53.4
0.15	9.0	0.40	24.0	0.65	39.0	0.90	54.0
0.16	9.6	0.41	24.6	0.66	39.6	0.91	54.6
0.17	10.2	0.42	25.2	0.67	40.2	0.92	55.2
0.18	10.8	0.43	25.8	0.68	40.8	0.93	55.8
0.19	11.4	0.44	26.4	0.69	41.4	0.94	56.4
0.20	12.0	0.45	27.0	0.70	42.0	0.95	57.0
0.21	12.6	0.46	27.6	0.71	42.6	0.96	57.6
0.22	13.2	0.47	28.2	0.72	43.2	0.97	58.2
0.23	13.8	0.48	28.8	0.73	43.8	0.98	58.8
0.24	14.4	0.49	29.4	0.74	44.4	0.99	59.4
0.25	15.0	0.50	30.0	0.75	45.0		

*From seconds of an arc to decimal minutes of an arc*

SEC	MIN	SEC	MIN	SEC	MIN	SEC	MIN
1	0.02	16	0.27	31	0.52	46	0.77
2	0.03	17	0.28	32	0.53	47	0.78
3	0.05	18	0.30	33	0.55	48	0.80
4	0.07	19	0.32	34	0.57	49	0.82
5	0.08	20	0.33	35	0.58	50	0.83
6	0.10	21	0.35	36	0.60	51	0.85
7	0.12	22	0.37	37	0.62	52	0.87
8	0.13	23	0.38	38	0.63	53	0.88
9	0.15	24	0.40	39	0.65	54	0.90
10	0.17	25	0.42	40	0.67	55	0.92
11	0.18	26	0.43	41	0.68	56	0.93
12	0.20	27	0.45	42	0.70	57	0.95
13	0.22	28	0.47	43	0.72	58	0.97
14	0.23	29	0.48	44	0.73	59	0.98
15	0.25	30	0.50	45	0.75		

---

## GEN 2.7 SUNRISE/SUNSET

### 2.7.1. INTRODUCTION

2.7.1.1 The Sunrise and Sunset 2022 tables were prepared by the "Centro de Analise e Previsao de Tempo" (Analysis and Weather Forecast Centre), a department of Instituto Nacional de meteorologia e geofisica, the Cabo Verde Meteorological Authority, and are reproduced with their permission. The tables include 7 public airports and aerodromes.

2.7.1.2 The times in the tables are given in UTC.

2.7.1.3 The tables can be obtained under <https://ais.asa.cv/ais/en/ais-3/sunrise-and-sunset-tables/>

**INTENTIONALLY LEFT BLANK**

## GEN 3. SERVICES

### GEN 3.1 AERONAUTICAL INFORMATION SERVICES

#### 3.1.1. Responsible service

3.1.1.1 The Aeronautical Information Service is provided by the Air Navigation Direction (DNA), through the Aeronautical Information Management Service (SGIA) - AIS / MAP, of ASA - Aeroportos e Seguranca Aerea - S.A..

3.1.1.2 The AIM is responsible for the flow of information necessary for the safety, regularity and efficiency of international and national air navigation within the area of its responsibility as indicated under **GEN 3.1.2** below. It consists of AIS headquarters, International NOTAM Office (NOF) and ARO units established at aerodromes listed under GEN 3.1.5 below.

#### 3.1.1.3 AIS Headquarter

Air Navigation Direction (DNA)  
Aeronautical Information Management Service (SGIA) - AIS / MAP  
Aeroporto Amilcar Cabral  
Espargos  
Sal Island  
Republic of Cabo Verde  
TEL: +238 2412502  
Telefax:+238 2413264  
e-mail: [sgia@asa.cv](mailto:sgia@asa.cv)  
AFS: GVACYOYX  
Http: <https://ais.asa.cv>

#### 3.1.1.4 International NOTAM Office (NOF)

Air Navigation Direction (DNA)  
International NOTAM Office  
Aeroporto Amilcar Cabral  
Espargos  
Sal Island  
Republic of Cabo Verde  
TEL: +238 2412090  
Telefax:+238 2413264  
e-mail: [sgia.nof@asa.cv](mailto:sgia.nof@asa.cv)  
AFS: GVACYNYX  
Http: <https://ais.asa.cv>

#### 3.1.1.5 Service hours

AIS service hours are as follows

- International NOTAM Office: H 24
- Aeronautical Information Management Service: MON - FRI during office hours (09:00 - 17:00)

#### 3.1.1.6 Applicable ICAO documents

The service is provided in accordance with the provisions contained in the following ICAO documents:

- Annex 15 - Aeronautical Information Service
- Doc 8126 - Aeronautical Information Service Manual
- Doc 10066 - Procedures for Air Navigation Services of Aeronautical Information Management.

Differences to these provisions are detailed in **GEN 1.7**

#### 3.1.2. Area of Responsibility

The Aeronautical Information Services is responsible for the collection and dissemination of information for the entire territory of the Republic of Cabo Verde and for High Sea Airspace under the Republic of Cabo Verde jurisdiction for air traffic purposes.

#### 3.1.3. Aeronautical publications

The Aeronautical information is provided in the form of aeronautical information products consisting of the following elements:

- Electronic Aeronautical Information Publication (eAIP)
- Electronic Amendment Service to the AIP (AIP AMDT)
- Electronic Supplement Service to the AIP (AIP SUP)
- NOTAM and Pre Flight Information Bulletins (PIB)
- Electronic Aeronautical Information Circulars (AIC) Service and
- Checklists and lists of valid NOTAM.

NOTAM and the related monthly checklist are issued via the Aeronautical Fixed Service (AFS) while PIB are made available at aerodrome AIS units. All other aeronautical products are published on the internet.

#### 3.1.3.1 Electronic Aeronautical Information Publication (AIP)

The electronic AIP is the basic source for permanent information and long duration temporary changes, which are essential for the safety of air navigation. The AIP is published in one volume and contains all relevant information for international civil aviation. It is published in English and updated by means of AIP Amendments and / or AIP Supplements.

The electronic AIP Cabo Verde is available in HTML format. The HTML version and a PDF version derived there-from is published on the internet and can be found at <https://ais.asa.cv/eaip>.

#### 3.1.3.2 Amendment Service to the electronic AIP

3.1.3.2.1 Amendments to the electronic AIP (AIP AMDT) are published on the internet.

3.1.3.2.2 There are two types of Amendments:

- Electronic regular AIP Amendments (AIP AMDT), containing permanent information which is not of operational significance for the safe conduct of a flight and does not require an advanced notification to the users. These electronic AIP AMDT are issued in accordance with the established regular intervals (**GEN 0.1.4.2**) and incorporate permanent changes into the electronic AIP at the indicated publication date;
- Electronic AIRAC AIP amendments (AIRAC AIP AMDT) containing permanent information which is of operational significance for the safe conduct of a flight and requires an advanced notification to the users. Electronic AIRAC AIP amendments are issued in accordance with the AIRAC system, identified by the acronym AIRAC at the indicated AIRAC effective date.

A brief description of the subjects affected by the amendment is given on the electronic AIP Amendment cover sheet. Each electronic AIP amendment cover sheet includes references to the serial number of those elements, if any, of the Aeronautical Information Products which have been incorporated in the electronic AIP by the amendment and are consequently cancelled. Each AIP AMDT and each AIRAC AIP AMDT will be allocated separate two digit serial numbers which are consecutive in line with the AIRAC cycle. This will be followed by a four digit number to denote the year of issue or validity, e.g. AIP AMDT 01 / 2022; AIRAC AIP AMDT 01 / 2022. This new system will supersede the old system (which used a continuous sequence of numbers).

3.1.3.2.3 For further details refer to the electronic AIP Republic of

Cabo Verde version on the internet and its Help section.

### 3.1.3.3 **Electronic Supplement Service to the electronic AIP (AIP SUP)**

3.1.3.3.1 Temporary changes of long duration (three months and longer) and information of short duration which consists of extensive text and / or graphics, supplementing the permanent information contained in the electronic AIP are published as electronic AIP Supplements (AIP SUP). Operationally significant temporary changes to the electronic AIP are published in accordance with the AIRAC system and its established effective dates are identified clearly by the acronym AIRAC.

3.1.3.3.2 Electronic AIP Supplements are separated by information subject (General - GEN, En-route - ENR and Aerodromes - AD). In a similar manner to AIP AMDT, each Supplement (regular or AIRAC) is allocated a serial number which is consecutive and based on the calendar year, i. e. AIRAC AIP SUP 01 / 2022.

3.1.3.3.3 Electronic AIP Supplements are kept in the AIP as long as all or some of their contents remain valid. The period of validity of information contained in the electronic AIP Supplement will normally be given in the supplement itself. Alternatively, NOTAM may be used to indicate changes to the period of validity or cancellation of the supplement.

3.1.3.3.4 The checklist of electronic AIP Supplements currently in force is issued additionally by the medium of the monthly printed plain language summary of NOTAM in force.

3.1.3.3.5 Electronic AIP Supplements are placed on the desktop of the electronic AIP as a separate subject item under the electronic AIP Tabulator "SUP". For further details refer to the electronic AIP Cabo Verde version on the internet and its Help section.

### 3.1.3.4 **Electronic Aeronautical Information Circular (AIC)**

3.1.3.4.1 The electronic Aeronautical Information Circulars (AIC) contain information of long - term forecast of any major change in legislation, regulations procedures or facilities; purely explanatory or advisory nature liable to affect flight safety; and information or notification of an explanatory or advisory nature concerning technical, legislative or purely administrative matters. AICs are divided in accordance with subjects and their affects and are issued in two series (A and N). AIC Series **A** contains information affecting international civil aviation and is given international distribution, while AIC Series **N** contains information affecting national aviation only and is given national distribution.

3.1.3.4.2 Each electronic AIC is numbered consecutively on a calendar year basis. The year, indicated by four digits, is a part of serial number of the AIC, e.g. AIC 1 / 2022. A checklist of AIC currently in force is issued as an AIC once a year.

3.1.3.4.3 Electronic AIC are placed on the desktop of the electronic AIP accordingly as a separate item under the eAIP Tabulator "AIC". For further details refer to the electronic AIP Cabo Verde version on the internet and its Help section.

### 3.1.3.5 **Notice to Airmen (NOTAM)**

3.1.3.5.1 A NOTAM is a notice distributed by means of Aeronautical Fixed Telecommunication Network (AFTN) containing information concerning the establishment, condition or change in any aeronautical facility, service, procedure or hazard, the timely knowledge of which is essential to personnel concerned with flight operations.

3.1.3.5.2 A NOTAM shall be originated and issued promptly whenever the information to be disseminated is of a temporary nature and of short duration or when operationally significant

permanent changes, or temporary changes of long duration are made at short notice.

3.1.3.5.3 When an AIP AMDT or an AIP SUP is published in accordance with the AIRAC procedures, a "TRIGGER" NOTAM shall be originated giving a brief description of the contents, the effective date, and the reference number to the AIP AMDT or AIP SUP.

3.1.3.5.4 The basic purpose of a NOTAM is the dissemination of information in advance of the event to which it relates, except in the case of unserviceability which cannot be foreseen.

3.1.3.5.5 A NOTAM checklist shall be issued via the AFTN for each month on the first day of the following month containing a numerical list of valid NOTAM in force, and referring to the latest AIP AMDT, AIP SUP and AIC issued.

3.1.3.5.6 A monthly printed Plain Language list of valid NOTAM including a reference to the latest AIP AMDT, checklist of AIP SUP and AIC issued, shall be prepared with a minimum delay and forwarded by the most expeditious means to recipients of the Aeronautical Information Products.

3.1.3.5.7 NOTAMs are originated and issued for SAL OCENIC FIR / UIR and are distributed in two series identified by the letter **A** and **S**.

**Series A - International distribution:** General rules, navigation warnings, en-route navigation and communication facilities, airspace reservations and navigation warnings, information concerning international aerodromes.

**Series S (SNOWTAM):** Information providing a surface condition report notifying the presence or cessation of hazardous conditions due to snow, ice, slush, frost, standing water or water associated with snow, slush, ice or frost on the movement area. SNOWTAMs are prepared in accordance with ICAO Doc 10066 (PANS - AIM) Appendix 4 and are issued for all international aerodromes.

### 3.1.3.6 **Checklist and list of valid NOTAM**

3.1.3.6.1 A checklist of valid NOTAMs is issued monthly via AFS. The checklist is followed by a printed list of valid NOTAMs distributed by mail to all recipients of the Integrated Aeronautical Information Package. It contains a plain language (in English) presentation of the valid NOTAM and information about the number of the latest issued AIP AMDT, AIRAC AIP AMDT, AIP SUP and AIC as well as the numbers of the elements issued under the AIRAC that will become effective or, if none, the NIL AIRAC notification.

3.1.3.6.2 Checklists and lists of valid NOTAMs are administrative material without operational significance. Their purpose is to help recipients of the Aeronautical Information Products verifying the continuity and validity of the information they handle.

### 3.1.3.7 **Distribution and sale of Publications**

3.1.3.7.1 This information is supplied free of charges to foreign Aeronautical Authorities and Aeronautical Information Services on a reciprocal basis. Nevertheless a registration is necessary to access the eAIP. Instructions to obtain access are given on the website.

3.1.3.7.2 Aeronautical Publications and the conditions of subscription, and respective purchase prices are published every year in an International AIC.

3.1.3.7.3 Orders, cancellations, claims and payment of subscriptions of all international aeronautical publications shall be addressed to:

**Aeronautical Information Management Service AIS / MAP**  
Aeroporto Amílcar Cabral

Espargos  
Sal Island  
Republic of Cabo Verde  
TEL: +238 2412502  
Telefax:+238 2413264  
e-mail: sgia@asa.cv  
AFS: GVACYOYX  
Http: https://ais.asa.cv

### 3.1.4. AIRAC system

In order to control and regulate operationally significant changes requiring amendments to charts, route manuals, etc., such changes, whenever possible, will be issued on predetermined dates according to the AIRAC SYSTEM. This type of information will be published as AIRAC AIP amendments or AIRAC AIP Supplement.

AIRAC information will be issued so that the information will be received by the user not later than 28 days, and for major changes not later than 56 days, before the effective date. The following table indicates AIRAC effective dates for Years 2022 to 2029:

2022	2023	2024	2025
27 January	26 January	25 January	23 January
24 February	23 February	22 February	20 February
24 March	23 March	21 March	20 March
21 April	20 April	18 April	17 April
19 May	18 May	16 May	15 May
16 June	15 June	13 June	12 June
14 July	13 July	11 July	10 July
11 August	10 August	08 August	07 August
08 September	07 September	05 September	04 September
06 October	05 October	03 October	02 October
03 November	02 November	31 October	30 October
01 December	30 November	28 November	27 November
29 December	28 December	26 December	25 December

2026	2027	2028	2029
22 January	21 January	20 January	18 January
19 February	18 February	17 February	15 February
19 March	18 March	16 March	15 March
16 April	15 April	13 April	12 April
14 May	13 May	11 May	10 May
11 June	10 June	08 June	07 June
09 July	08 July	06 July	05 July
06 August	05 August	03 August	02 August
03 September	02 September	31 August	30 August
01 October	30 September	28 September	27 September
29 October	28 October	26 October	25 October
26 November	25 November	23 November	22 November
24 December	23 December	21 December	20 December

### 3.1.5. Pre - flight information service at aerodromes / heliports

Air Traffic Services Reporting Office (ARO) units are established at the airports of Sal Island / Amilcar Cabral, Praia / Nelson Mandela, Rabil / Aristides Pereira and Sao Pedro / Cesaria Evora.

ARO Unit / hours of Service	Telephone	Telefax	AFTN
Sal Island / Amilcar Cabral H24	+238 2411309	+238 2411309	GVACZPZX
Praia / Nelson Mandela H24	+238 2633471	NIL	GVNPZPZX
Rabil / Aristides Pereira 09:00 - 19:00	+238 2511070	+238 2511010	GVBAZPZX

Sao Pedro / Cesaria Evora 07:00 - 23:00	+238 2323716	+238 2323716	GVSVPZPX
--	--------------	--------------	----------

3.1.5.1 A pre - flight information service unit is available at all ATS Reporting Offices (ARO's), covering areas of its responsibility.

3.1.5.2 Pre Flight Information Bulletins (PIB) are prepared in accordance with ICAO Annex 15, ICAO Doc 8126 and 10066. A selection of different PIB is possible and the following types are available.

For IFR or VFR flight:

- Route type PIB
- Aerodrome type PIB
- Area type PIB
- Navigation Warnings

**Note:**

- *In all these PIB's a set of filters may be applied, namely: Date and duration of the flight, Qualifiers (Traffic, Purpose and Scope), and flight levels used.*
- *The languages used by all ATS Reporting Offices (ARO's) are Portuguese and English or French.*

**3.1.6. Digital data sets**

To be developed.



## GEN 0.1 AERONAUTICAL CHARTS

### 0.1.1. Responsible service

0.1.1.1 All the aeronautical charts for use by civil aviation are published under the authority of the aeronautical Information Management.

0.1.1.2 These charts are produced in accordance with specifications set down in ICAO Annex 4 and other pertinent ICAO documents.

### 0.1.2. Maintenance of charts

0.1.2.1 The aeronautical charts included in the AIP are regularly kept up to date or are replaced by the amendments to the AIP. Significant revisions to aeronautical chart series are also included in the AIP and may be promulgated in the AIP SUP, if appropriate. Information concerning new maps and charts will be notified by Aeronautical Information Circular.

0.1.2.2 Items and information found after publication to have been incorrect at the aeronautical information date, are corrected immediately by NOTAM if they are of operational significance, attention being directed to the particular chart affected.

0.1.2.3 Revision of the aeronautical information on all charts is constantly in progress and amended charts are published as regularly as production resources permit. Topographical and hydro graphical information portrayed is also revised when necessary.

### 0.1.3. Purchase arrangements

0.1.3.1 All charts are incorporated in the AIP and may be obtained from:

Aeronautical Information Management Service (SGIA) - AIS / MAP  
Aeroporto Amilcar Cabral  
Espargos  
Sal Island  
Republic of Cabo Verde  
TEL: +238 2412502  
Telefax:+238 2413264  
e-mail: sgia@asa.cv  
AFS: GVACYOYX  
Http: NIL

### 0.1.4. Aeronautical chart series available

0.1.4.1 The following series of aeronautical charts are produced:

- a) World Aeronautical Chart - ICAO 1:1 000 000;
- b) Aerodrome Chart - ICAO;
- c) Aerodrome Obstacle Chart - ICAO type A (for each runway);
- d) En-route Chart - ICAO;
- e) Standard Departure Chart - Instrument (SID) - ICAO;
- f) Standard Arrival Chart - Instrument (STAR) - ICAO;
- g) Instrument Approach Chart - ICAO (for each runway and procedure type);
- h) Visual Approach Chart - ICAO.
- i) Aerodrome Parking / Docking Chart - ICAO

The charts currently available are listed under paragraph 5 of this subsection.

#### 0.1.4.2 General Description of each Series

##### a) World Aeronautical Chart - ICAO 1:1000 000

This series is constructed on Lambert Conformal Conic Projection in accordance with ICAO specifications. The chart

provides information to satisfy visual air navigation and is also used as a pre - flight planning chart.

##### b) Aerodrome Chart - ICAO

This chart contains aerodrome data to provide flight crews with information that will facilitate the ground movement of aircraft:

- from the aircraft stand to the runway; and
- from the runway to the aircraft stand.

It also provides essential some operational information at Sal Island / Amilcar Cabral, Praia / Nelson Mandela, Rabil / Aristides Pereira and Sao Pedro / Cesaria Evora.

##### c) Aerodrome Obstacle Chart - ICAO Type A

This chart contains detailed information on obstacles in Sal Island / Amilcar Cabral, Praia / Nelson Mandela, Rabil / Aristides Pereira and Sao Pedro / Cesaria Evora Airports. This obstacle information provides the data necessary to enable an operator to comply with the operating limitations of ICAO Annex 6, Parts I and II, Chapter 5.

##### d) En-route Chart - ICAO

This chart is produced for the entire SAL OCENIC FIR / UIR. This chart provides the flight crew information to facilitate navigation along ATS routes in compliance with Air Traffic Services procedures.

##### e) Standard Departure Chart - Instrument (SID) - ICAO

This chart is produced whenever a standard departure route - instrument has been established and cannot be shown with sufficient clarity on the Area Chart - ICAO. The aeronautical data shown include the aerodrome of departure and aerodrome(s) which affect the designated standard departure route - instrument. This chart provides the flight crew with information that will enable them to comply with the designated standard departure route - instrument from the take - off phase to the en - route phase.

##### f) Standard Arrival Chart - Instrument (STAR) - ICAO

This chart is produced for all aerodromes used by civil aviation where instrument approach procedures have been established. This chart provides the flight crew with information that will enable them to perform an approved instrument approach procedure to the runway of intended landing including the missed approach procedure and where applicable, associated holding patterns.

##### g) Instrument Approach Chart - ICAO (for each runway and procedure type)

This chart provides the flight crew with information that will enable them to perform an approved instrument procedure to the runway of intended landing including the missed approach procedure and where applicable, associated holding patterns.

This chart is produced for all aerodromes used by civil aviation where instrument approach procedures have been established.

##### h) Visual Approach Chart - ICAO

This chart provides flight crew with information which enable them to transit from the enroute / descent to approach phases of flight to the runway of intended landing by means of visual reference.

This chart is produced for aerodromes used by civil aviation where:

- only limited navigation facilities are available; or
- radio communication facilities are not available; or
- no adequate aeronautical charts of the aerodrome and its surroundings at 1:500 000 or greater scale are available; or
- visual approach procedures have been established.

i) **Aerodrome Parking / Docking Chart - ICAO**

This supplementary chart provides flight crew with detailed information to facilitate the ground movement of aircraft between the taxiway and the aircraft stands and the parking / docking of aircraft.

**0.1.5. List of aeronautical charts available**

0.1.5.1 The available charts are part of the AIP. The charts are not for sale separately.

0.1.5.2 A detailed list of charts related to each individual airport is given in the relevant aerodrome subsection, AD 2.24. For each aerodrome there is at least an aerodrome chart and a visual approach chart published. A detailed list of charts related to en - route and area can be seen at ENR 6.

**0.1.6. Index to the World Aeronautical Chart (WAC) - ICAO 1:1 000 000**

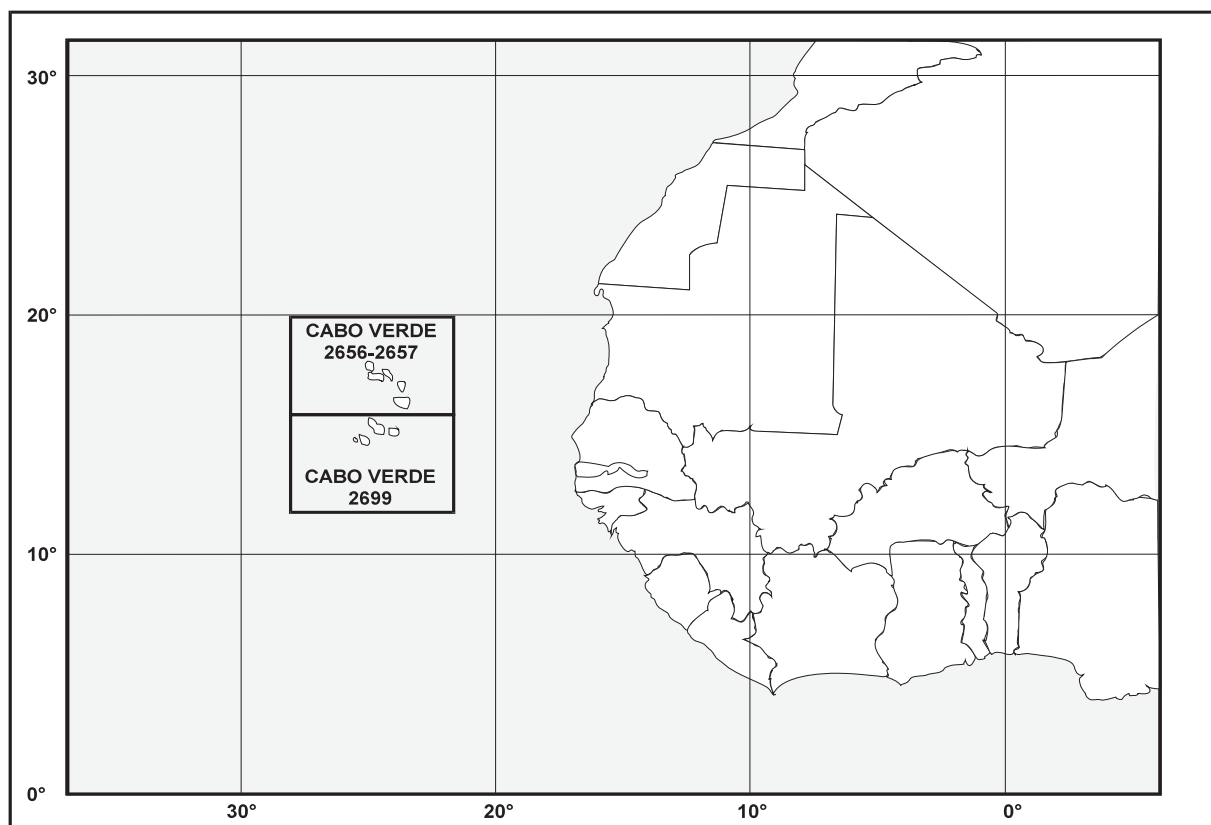

**0.1.7. Topographical charts**

NIL

**0.1.8. Correction to charts not contained in the AIP**

NIL

## GEN 3.3 AIR TRAFFIC SERVICES

### 3.3.1. Responsible services

3.3.1.1 The Air Traffic Service is provided by the Air Navigation Direction (DNA), through the Air Traffic Operation Service (SOTA), of ASA - Aeroportos e Seguranca Aerea - S.A..

Air Navigation Direction (DNA)  
Air Traffic Operation Service (SOTA)  
Aeroporto Amilcar Cabral  
Espargos  
Sal Island  
Republic of Cabo Verde  
TEL: +238 2419200  
Telefax:+238 2413336  
e-mail: NIL  
AFS: GVACDNAX  
Http: NIL

3.3.1.2 The services are provided in accordance with the provision contained in the following ICAO documents

- a) ANNEX 2 - Rules of the Air
- b) ANNEX 11 - Air Traffic Services
- c) DOC 4444 - Procedures for Air Navigation Services - Air Traffic Management (PANS - ATM)
- d) DOC 8168 - Procedures for Air Navigation Services - Aircraft Operations (PANS - OPS)
- e) DOC 7030 - Regional Supplementary Procedures

**Note:** Differences to this provision are detailed in subsection **GEN 1.7**.

### 3.3.2. Area of responsibility

3.3.2.1 Air Traffic Services are provided for the entire territory of Cabo Verde, including its territorial waters as well as the airspace over the high seas within the SAL OCENIC FIR / UIR.

3.3.2.2 In some cases, in accordance with the regional air navigation agreement, air traffic services are provided, under the delegated authority, in the airspace within another bordering FIR. Details of such services are provided in section ENR. 2.

### 3.3.3. Type of service

3.3.3.1 The following types of service are provided:

- a) Flight Information Service (FIS) and Alerting Services (FIC)
- b) Area Control (ACC)
- c) Approach Control (APP) and
- d) Radar

3.3.3.2 The following types of services are provided at aerodromes:

- a) Aerodrome Control (TWR), or
- b) Aerodrome Flight Information (AFIS), where applicable

3.3.3.3 Provision of flight information service within SAL OCENIC FIR

Flight Information service (FIS) is a non - radar service provided, either separately or in conjunction with other services, for the purpose of supplying information useful for the safe and efficient conduct of flights. Under a FIS the following conditions apply:

- a) Provision of the service includes information about weather, changes of serviceability of facilities, conditions at aerodromes and any other pertinent information.

- b) The controller may attempt to identify the flight for monitoring and coordination purposes only. Such identification does not imply that the radar service is being provided or that the controller will continuously monitor the flight. Pilots must be left in no doubt that they are not receiving a radar service.
- c) Controller are not responsible for separating or sequencing aircraft.

In addition to the above, controllers will, subject to workload, provide pilots with information concerning collision hazards to aircraft operating in Class "G" airspace when self evident information from any source indicates that the risk of collision may exist. It is accepted that this information may be incomplete and the controller cannot assume responsibility for its issuance at all times or for its accuracy. At ACC, controllers will provide FIS on request to aircraft both along with and, when necessary, separate from other service provision. This service is provided on ATC sector on its associated frequency. Warnings of proximity hazards should be issued when, from aircraft reports, they are self evident but decision to make any alteration to the flight profile remains with the pilot. Warnings are issued at the discretion of the controller and take the form of traffic information passed to each involved flight.

### 3.3.4. Co - ordination between the operator and ATS

Co - ordination between the operator and air traffic service is effective in accordance with 2.15 of ICAO Annex 11.

### 3.3.5. Minimum flight altitude

3.3.5.1 The minimum flight altitudes on the ATS routes, as presented in section ENR 3, have been determined so as to ensure a least 300 M (1000 FT) vertical clearance above the highest obstacle within 8 KM (4.3 NM) on each side of the centre line of the route.

3.3.5.2 However, where the angular divergence of the navigational air signal, in combination with the distance between the navigation aids could result in an aircraft being more than 8 KM (4.3 NM) on either side of the centre line the 18 KM (9.7 NM) protection limit is increased by the extent to which the divergence is more than 8 KM (4.3 NM) from the centre line.

3.3.6. ATS unit address list

<i>Unit Name</i>	<i>Postal address</i>	<i>Telephone Number</i>	<i>Telefax Number</i>	<i>Telex Number</i>	<i>AFS address</i>
<i>1</i>	<i>2</i>	<i>3</i>	<i>4</i>	<i>5</i>	<i>6</i>
SAL ACC	Aeroporto Amilcar Cabral Espargos Sal Island Republic of Cabo Verde	+238 2411135 +238 2411730	+238 2411570 +238 2411219	NIL	GVSCZRZX
SAL APP	Aeroporto Amilcar Cabral Espargos Sal Island Republic of Cabo Verde	+238 2411135 +238 2411730	+238 2411219	NIL	GVACZTZX
AMILCAR CABRAL FIC	Aeroporto Amilcar Cabral Espargos Sal Island Republic of Cabo Verde	+238 2411135 +238 2411730	+238 2411219	NIL	GVSCZRZX
SAL RADIO	Aeroporto Amilcar Cabral Espargos Sal Island Republic of Cabo Verde	+238 2412090	+238 2413264	NIL	GVACYSYX

## GEN 3.4 COMMUNICATION AND NAVIGATION SERVICES

### 3.4.1. Responsible Service

3.4.1.1 The Communication and Navigation Services are provided by the Air Navigation Direction (DNA), through the Communication, Surveillance and Navigation Service (SCVN), of ASA - Aeroportos e Seguranca Aerea - S.A..

Air Navigation Direction (DNA)  
Communication, Surveillance and Navigation Service (SCVN)  
Aeroporto Amilcar Cabral  
Espargos  
Sal Island  
Republic of Cabo Verde  
TEL: +238 2419200  
Telefax:+238 2413336  
e-mail: NIL  
AFS: GVACDNAX  
Http: NIL

3.4.1.2 The service is provided in accordance with the provision contained in the following ICAO documents:

- a) Annex 10 - Aeronautical Telecommunications
- b) DOC 8400 - Procedures for Air Traffic Navigation Services - ICAO Abbreviations and Codes (PANS - ABC)
- c) DOC 8585 - Designators for Aircraft Operating Agencies, Aeronautical Authorities and Services
- d) DOC 7030 - Regional Supplementary Procedures
- e) DOC 7910 - Location Indicators

**Note:** Differences to this provision are detailed in subsection GEN 1.7.

### 3.4.2. Area of responsibility

3.4.2.1 Communication Services are provided for the entire SAL OCENIC FIR / UIR.

3.4.2.2 Responsibility for the day - to - day operation of these services is vested in the Station Communication Officers located at each international aerodrome.

3.4.2.3 Inquiries, suggestions or complains regarding any communication service should be referred to the relevant Station Communication Officer or to the Director of Air Navigation.

### 3.4.3. Type of service

#### 3.4.3.1 Radio navigation services

The following types of radio aids to navigation are available:

- a) LF / MF Non - directional Beacon (NDB)
- b) Instrument Landing System (ILS)
- c) VHF Omni directional Radio Range (VOR)
- d) Distance - Measuring Equipment (DME)
- e) Approach and Regional Control Radar

#### 3.4.3.2 Voice and & or data link services

##### 3.4.3.2.1 Mobile service

The aeronautical stations maintain a continuous watch on their stated frequencies during the published hours of service unless otherwise notified.

An aircraft should normally communicate with the air / ground control radio station that exercises control in the area in which the aircraft is flying. Aircraft should maintain a continuous watch on the appropriate frequency of the control station and should not abandon

watch, except in an emergency, without informing the control radio station.

##### 3.4.3.2.2 Fixed service

The messages to be transmitted over the Aeronautical Fixed Service (AFS) are accepted only if:

- a) They satisfy the requirements of ICAO Annex 10, Vol II, Chap. 3.3.3
- b) They are prepared in the form specified in ICAO Annex 10
- c) The text of an individual message does not exceed 200 groups

**Note:** General aircraft operating messages, designated as Class B2, are not acceptable.

##### 3.4.3.3 Broadcasting service

NIL

##### 3.4.3.4 Language used

English and Portuguese

##### 3.4.3.5 Where detailed information can be obtained

Details of the various facilities available at the individual aerodromes can be found in the relevant sections of Part 3 (AD). In cases where a facility is serving both the en - route traffic and the aerodromes, details are given in the relevant sections of Part 2 (ENR) and Part 3 (AD).

### 3.4.4. Requirements and conditions

NIL

### 3.4.5. Miscellaneous

See following figures of AFTN circuit network.

Aeronautical Fixed Services (Telegraph)

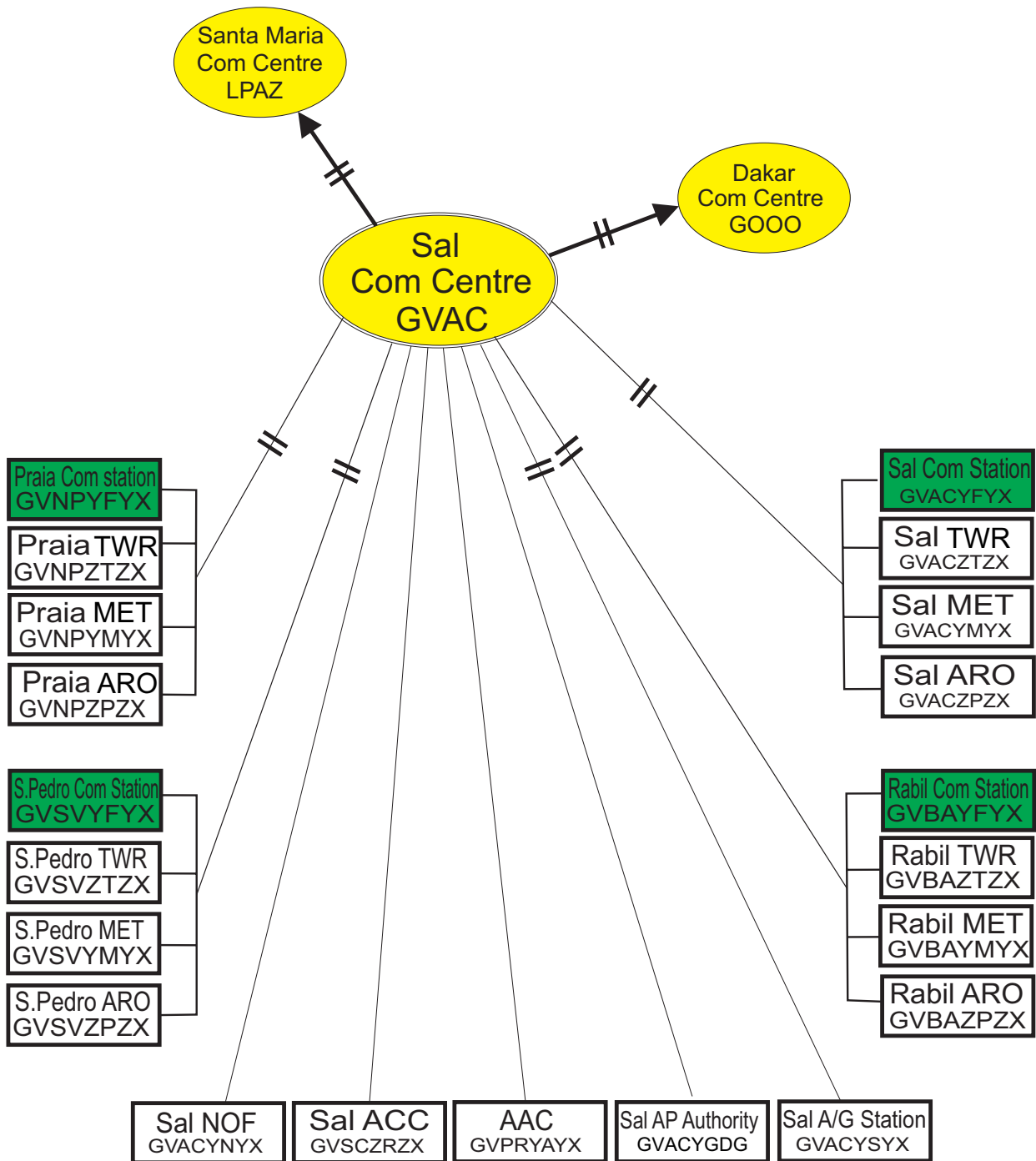

LEGEND	
SIMPLEX CIRCUIT	I
DUPLEX CIRCUIT	II
COM CENTER	—
AFS STATION	—

Aeronautical Fixed Services (Telephone)

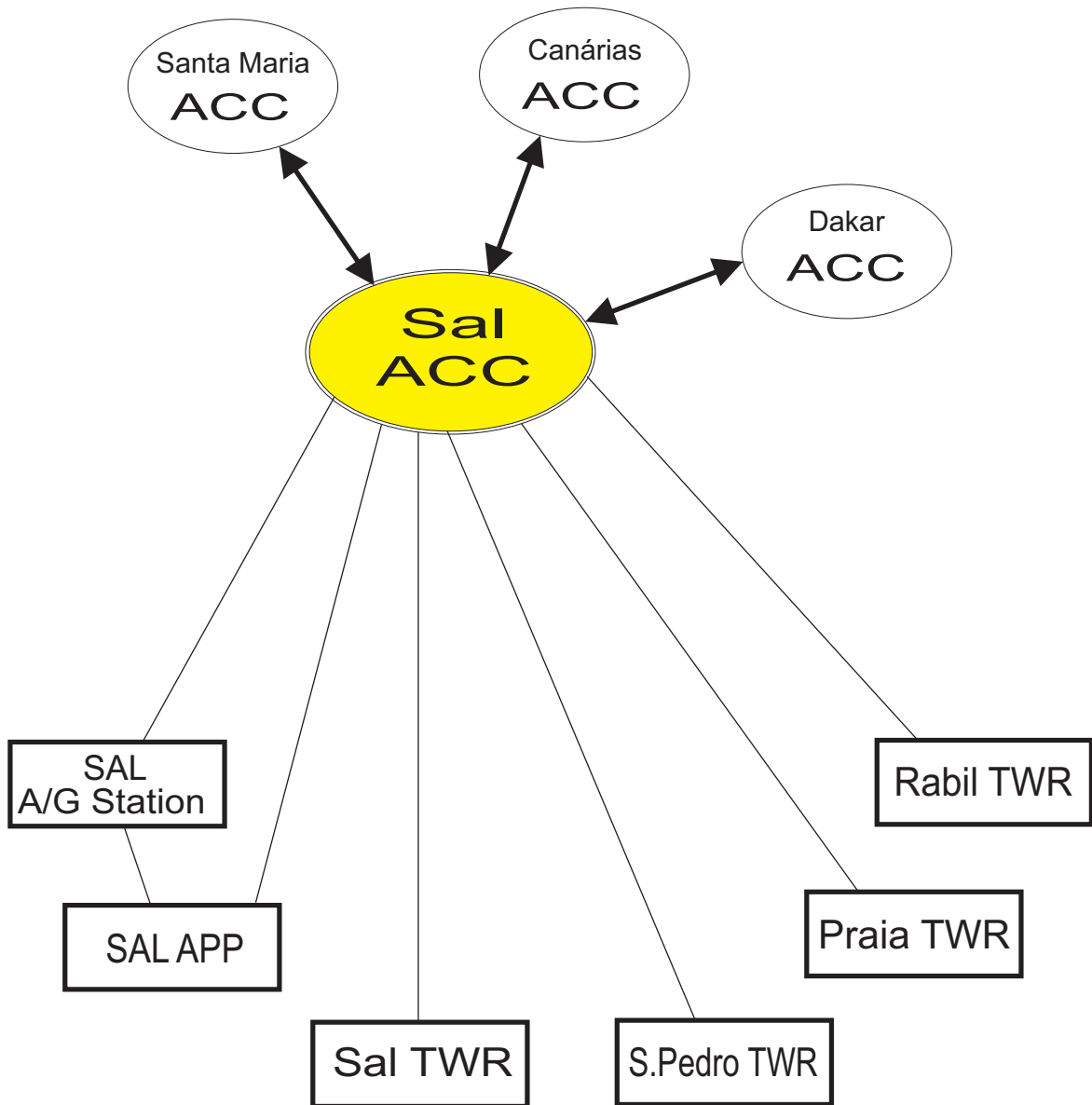

**INTENTIONALLY LEFT BLANK**



---

## GEN 3.5 METEOROLOGICAL SERVICES

### 3.5.1. Responsible service

3.5.1.1 The Meteorological Services are provided by the National Institute of Meteorology and Geophysics (INMG).

National Institute of Meteorology and Geophysics (INMG)

Aeroporto Amílcar Cabral

P.O. Box 76

Espargos

Sal Island

Republic of Cabo Verde

TEL: +238 2411658

+238 2411276

Telefax:+238 2411294

e-mail: inmg.maa@gmail.com

AFS: GVACYMYX

Http: www.inmg.gov.cv

3.5.1.2 The services are provided in accordance with the provision contained in ICAO Annex 3 - Meteorological Service for International Air Navigation.

**Note:** Differences to this provision are detailed in subsection **GEN 1.7**.

### 3.5.2. Area of responsibility

Meteorological Services are provided for the entire SAL OCENIC FIR / UIR.

### 3.5.3. Meteorological observations and reports

**Table GEN 3.5.3 Meteorological observations and reports**

Name of station/ Location indicator	Type & frequency of observation/automatic observing equipment	Types of MET reports & availability of trend forecasts	Observation System & site(s)	Hours of operation	Climatological information
1	2	3	4	5	6
Sal Island / Amilcar Cabral GVAC	Hourly plus Special Observation	METAR SPECI TREND	WDI left side of RWY 01 MDD Station  ANEMOMETER CUP RWY 01 and RWY 19  AWOS: Surface wind both runways, visibility + RVR, temperature, dew point, relative humidity, sky conditions, cloud height and amount, altimeter setting and rainfall	H24	Climatological tables available
Praia / Nelson Mandela GVNP	Hourly plus Special Observation	METAR SPECI TREND	WDI left side of RWY 03 and right side of RWY 21  ANEMOMETER CUP RWY 03  AWOS: Surface wind both runways, visibility + RVR, temperature, dew point, relative humidity, sky conditions, cloud height and amount, altimeter setting and rainfall	H24	NIL
Maio Island / Maio GVMA	Only when AD operations are available	METAR SPECI	WDI left side of RWY 01 AWOS: Surface wind for RWY 01, temperature, dew point, relative humidity and altimeter setting	HO	NIL
Rabil / Aristides Pereira GVBA	Hourly plus Special Observation	METAR SPECI	WDI left side of RWY 03 and RWY 21  ANEMOMETER CUP RWY 03  AWOS: Surface wind both runways, visibility + RVR, temperature, dew point, relative humidity, sky conditions, cloud height and amount, altimeter setting and rainfall	0900 - 1900	NIL
Sao Pedro / Cesaria Evora GVSV	Hourly plus Special Observation	METAR SPECI TREND	Left side of RWY 06 and right side of RWY 24  Anemometer cup RWY 06  AWOS: Surface wind for both RWYs, visibility + RVR, temperature, dew point, relative humidity, sky conditions, cloud height and amount, altimeter setting and rainfall.	H24	NIL

**Table GEN 3.5.3 Meteorological observations and reports**

<i>Name of station/ Location indicator</i>	<i>Type &amp; frequency of observation/automatic observing equipment</i>	<i>Types of MET reports &amp; availability of trend forecasts</i>	<i>Observation System &amp; site(s)</i>	<i>Hours of operation</i>	<i>Climatological information</i>
1	2	3	4	5	6
Sao Nicolau Island / Preguica GVSN	Hourly 09:00 - 19:00	METAR SPECI	WDI left side of RWY 01 and right side of RWY 19  AWOS: Surface wind for RWY 01, temperature, dew point, relative humidity and altimeter setting.	07:00 - 19:00	NIL
Fogo Island / Sao Filipe GVSF	Hourly 07:00 - 19:00	METAR SPECI	WDI Left side of RWY 14 and left side of RWY 32.  AWOS: Surface wind for RWY 14, temperature, dew point relative humidity and altimeter setting.	07:00 - 19:00	NIL

**3.5.4. Types of services**

3.5.4.1 Personal briefing and consultation for flight crew members is provided. Flight documentation comprises a significant weather chart, an upper wind and upper air temperature chart and the latest available aerodrome forecast for the destination and, if required, for its alternate aerodromes.

3.5.4.2 For the planning of VFR flights, plain - language summary forecast of en - route weather conditions may be requested from Sal.

3.5.4.3 Cloud height is measured by ceilometers. These observations are representative of the landing area.

3.5.4.4 Distant reading thermometers at Sal Island / Amilcar Cabral, Praia / Nelson Mandela and Sao Pedro / Cesaria Evora are used to measure the air temperature in conditions normally representative of the temperature over the runways.

**3.5.5. Notification required from operators**

3.5.5.1 Notification from Operators in respect of briefing, consultation, flight information needed by them (ref. ICAO Annex 3, 2.3) is normally for inter - continental flights of more than 3500 KM. Such notification should be received at least 6 hours before the expected time of departure.

### 3.5.6. Aircraft reports

Pursuant to ICAO Annex 3, 5.3.1 the making and transmission of aircraft reports (AIREP) are required at the following ATS reporting Points:

EDUMO	TENPA	IPERA	GUNET	GAMBA	IREDO	CVS	ORABI	KENOX
AMDOL	POMAT	ONOB	BOTNO	TUTLO	XIBOT	VEPOP	ERNEK	TEGTO
ULTEM	RUKAV	OBOMO	BAMUX	PIXED	XIGLU	ILGAS	SEPOM	LUMPO
MOGSA	BORTA	TARIM	XUVIT	BIKOM	NATAS	GARPO		

The ATS / MET reporting points in respect of routes crossing FIR / UIR are at the following points: IPERA, CVS, ONOB, AMDOL, LUMPO, MOGSA, ULTEM, KENOX and EDUMO.

### 3.5.7. VOLMET Service

NIL

### 3.5.8. SIGMET Service

Table GEN 3.5.8 SIGMET service

Name of MWO / location indicators	Hours	FIR or CTA served	Type of SIGMET / validity	Specific procedure	ATS unit served	Additional information
1	2	3	4	5	6	7
SAL	H24	SAL OCENIC FIR / UIR	SIGMET / 4 HR	NIL	SAL ACC	NIL

#### 3.5.8.1 General

For the safety of air traffic, the meteorological authority maintains an area meteorological watch and warning service. This service consists partially of a continuous weather watch within the lower and upper FIR and the issuance of appropriate information (SIGMET) by Meteorological Watch Offices (MWO) and partially of the issuing of warning for the respective aerodrome and, subject to agreement, for other aerodromes by all aeronautical MET offices.

#### 3.5.8.2 Area meteorological watch service

The area meteorological watch service is performed by the following Meteorological Watch Office:

- Main Aeronautical Meteorology Centre (Centro de Meteorologia Aeronautica Principal)

The MWOs issue information in the form of SIGMET messages about the occurrence or expected occurrence of one or several of the following significant meteorological phenomena:

- thunderstorms
- severe turbulence
- severe icing
- severe mountain waves
- heavy sand storm / dust storm
- volcanic ash cloud
- tropical cyclone

The SIGMETs are issued in abbreviations and plain language using ICAO abbreviations and are numbered consecutively for each day commencing at 0001. Their period of validity is generally limited to less than 4 hours from the time of transmission.

The MWOs transmit SIGMETs issued by themselves, as well as SIGMETs of adjacent MWOs and, upon agreement, also SIGMETs of other MWOs, to the regional control centre competent for the FIR or UIR concerned.

In addition to the issuance of SIGMETs, the MWOs will inform the regional control centre about the occurrence or expected occurrence of thunderstorms, moderate icing, light to moderate hail, or moderate

turbulence within the FIRs concerned. The information is intended for the safety of low level flights and is limited to the lower airspace.

#### 3.5.8.3 Warning service

Warnings for the protection of parked and moored aircraft or other equipment at the airport are issued by all aerodrome meteorological offices, if one or several of the following phenomena are expected to occur at the airport:

- squall
- thunderstorm
- hail
- frost
- heavy rime deposit
- heavy snow
- freezing precipitation

Differences from these criteria have to be agreed upon locally.

The warnings are generally issued in English and are distributed in accordance with a distribution list which has to be agreed upon locally. In order to guarantee rapid dissemination of the warnings, the distribution list to be used shall, as far as possible, contain only one recipient for an interested group. This recipient will be responsible for the further dissemination of the warning within the group.

SIGMET information is disseminated through directed transmissions to aircraft general calls

- by the Area Control Centre (SAL ACC) for SAL OCENIC FIR / UIR
- by the ATS unit for their own area of responsibility.

**3.5.9. Other automated meteorological services**

**Table GEN 3.5.9 Other automated meteorological services**

<i>Service name</i>	<i>Information available</i>	<i>Area, route and airport coverage</i>	<i>Telephone and telefax numbers Remarks</i>
<i>1</i>	<i>2</i>	<i>3</i>	<i>4</i>
National Institute of Meteorology and Geophysics	TAF, METAR, Satellite imagery, Analysis charts of MSL Pressure FCST charts WINTEN FL 180, 300, 390, SGWX, Aviation WX WRNG.	SAL OCENIC FIR / UIR	TEL: +238 2411658 +238 2411276 Telefax:+238 2411294  Administrative Services 09:00 - 17:00

**INTENTIONALLY LEFT BLANK**

**GEN 3.6 SEARCH AND RESCUE****3.6.1. Responsible service**

3.6.1.1 The national SAR system includes the Government, SAR Committee, Joint Rescue Coordination Centre, SAR Sub - Centre, Alert Post, SRU, Rescue Teams and Aeronautical SAR authority (the CAA) and Maritime SAR authority (AMP). The CNCSAR, AMP and AAC are responsible for establishing policies, regulations and supervising SAR Services.

3.6.1.2 The Postal and AFS address of the AAC are given in the Cabo Verde AIP page **GEN 1.1.1**

3.6.1.3 The SAR Provider is responsible for planning and coordination of SAR operations. The Joint Rescue and Coordination Center (JRCC) located in the Sao Pedro / Cesaria Evora VTS facilities.

Joint Rescue and Coordination Center (JRCC)

Aeroporto Cesaria Evora

VTS Center

Mindelo

Sao Vicente Island

Republic of Cabo Verde

TEL: +238 2325555

+238 5820125

+238 5820119

Telefax:+238 2324271

e-mail: jrcc@gmail.com

coordenador.sarcv@gmail.com

coordenador.sarcv@fa.gov.cv

AFS: NIL

Http: NIL

**Note:** COSPAS SARSAT POC TEL: +238 2324271

3.6.1.4 The service is provided in accordance with the provisions contained in the following ICAO documents:

- a) Annex 2 - Rules of the Air (Appendix A)
- b) Annex 11 - Air Traffic Service
- c) Annex 12 - Search and Rescue
- d) Annex 13 - Aircraft Accident Inquiry
- e) DOC 7030 - Regional Supplementary Procedure (Alerting and Search and Rescue)
- f) DOC 9432 - Radio telephony Manual
- g) DOC 9731 - AN / 958: IAMSAR Manual

**3.6.2. Area of Responsibility**

The search and rescue service is responsible for SAR operations within SAL OCENIC FIR / UIR.

**3.6.3. Types of Services**

Details of related rescue units are given in Table 3.6.3 - Search and Rescue Units. In addition, various elements of the State Police organisation, the merchant marine and the armed forces are also available for search and rescue missions, when required.

**Table GEN 3.6.3 Search and Rescue Units**

Name	Location	Facilities	Remarks
1	2	3	4
Dakar	144014.73N 0170422.15W	1 Brequet BR1150 Atlantic (VLR)	On standby from Dakar 3 hours prior notice
Ministry of National Defence - Coast Guard	Porto Grande Mindelo	Patrol Ship "Guradio" 478 T, 20 KT max. - 27 crew members - autonomy 12 KT / 10 days	SAR Posture - 2 hours prior notice
Ministry of National Defence - Coast Guard	Porto Grande Mindelo	Patrol Ship "Esparate" 20 T, 20 KT max - 6 crew members - autonomy 2 days	SAR Posture - 2 hours prior notice
Ministry of National Defence - Coast Guard	Porto da Praia Santiago	Patrol Ship "DJEU" 68 T, 19 KT max. 10 crew members - autonomy 400 NM / 18 KT	SAR Posture - 2 hours prior notice
Ministry of National Defence - Coast Guard	Porto Grande Mindelo	Patrol Ship "Badejo" 68 T, 19 KT max. 10 crew members - autonomy 400 NM / 18 KT	SAR Posture - 2 hours prior notice
Ministry of National Defence - coast Guard	Porto de Tarrafal Sao Nicolau	Patrol Ship "Rei" 12.51 T, 35 - 40 KT max. 4 crew members autonomy 10 Hours / 24 KT	SAR posture - 2 hours prior notice
Ministry of National	Porto da Praia Santiago	SAR / V "Ponta Nho Martinho" 32 - 34 KT max. 4 crew members autonomy 9 hours / 24 KT	SAR Posture - 2 hours prior notice
Defence - Coast guard	Porto Grande Mindelo	SAR / V "Ilheu dos Passaros" 32 - 34 KT max. 4 crew members autonomy 9 hours / 24 KT	SAR Posture - 2 hours prior notice

**3.6.4. SAR Agreements**

The Republic of Cabo Verde has SAR agreements with France, based in Dakar, Portugal and Spain concerning the provision of assistance upon receipt by the former of a request from the latter for aid. Those agreements provides for facilitation of the over - flight and landing of search and rescue aircraft without prior permission. The dispatch of a flight plan will notify the authorities controlling entry. All costs will be defrayed for stopovers, accommodation and transportation of crew members, and for direct communication between the two SAR services on all common search and rescue matters. Copies of this agreement are available, upon request, from the Civil Aviation Agency (AAC).

**3.6.5. Conditions of availability**

The SAR service and facilities in Cabo Verde are available without charge to neighbouring States upon request to the Civil Aviation Administration at all times when they are not engaged in search and rescue operations in their home territory. All facilities are specialised in SAR techniques and functions.

**3.6.6. Procedures and signals used**

**3.6.6.1 Procedures and signals used by aircraft**

Procedures for pilots - in - command observing an accident or intercepting a distress call and / or message are outlined in Annex 12, Chapter 5.

**3.6.6.2 Communications**

3.6.6.2.1 Transmission and reception of distress messages within Sal Oceanic Search and Rescue Areas are handled in accordance with ICAO Annex 10, Volume II, 5.3.

3.6.6.2.2 For communications during Search and Rescue operations the codes and abbreviations published in ICAO DOC 8400 are used.

3.6.6.2.3 Information concerning positions, call signs, frequencies and hours of operation of the Republic of Cabo Verde aeronautical stations is published in AD 2.18.

3.6.6.2.4 Aeronautical stations will, on request, guard the international emergency frequency 121.500 MHZ. All coast stations guard the international distress frequency.

3.6.6.2.5 Rescue aircraft belonging to permanent Search and Rescue Units use the call-sign "Rescue" and additional identification marks (ALFA, BRAVO, CHARLIE, etc.) during rescue operations.







**3.6.6.3 Search and Rescue Signals**

The Search and Rescue signals to be used are those prescribed in ICAO Annex 12, 5.8.

**3.6.6.4 Ground / Air visual signal codes for use by survivors**

Symbols		
1.	Require assistance	V
2.	Require medical assistance	X
3.	No or negative	N
4.	Yes or affirmative	Y
5.	Proceeding in this direction	↑
Instructions for use		
1.	Make signals not less than 8 FT (2.5 M).	
2.	Take care to lay out signals exactly as shown.	
3.	Provide as much colour contrast as possible between signals and background.	
4.	Make every effort to attract attention by other means such as radio, flares, smoke, reflected light.	

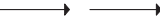
**3.6.6.5 Ground - air visual signal code for use by rescue units**

Symbols		
1	Operation completed	
2	We have found all personnel	
3	We have found only some personnel	
4	We are not able to continue returning to base	
5	Have divided into two groups each proceeding in the direction indicated	
6	Information received that aircraft is in this direction	
7	Nothing found will continue to search	



## GEN 4. CHARGES FOR AERODROMES / HELIPORTS AND AIR NAVIGATION SERVICES

### GEN 4.1 AERODROME / HELIPORT CHARGES

#### 4.1.1. Landing of aircraft

The landing and take-off is the counterpart to the use of visual aids for landing and take-off, as well as the use of the infrastructures inherent in the movement of aircraft on the ground after landing and for the purpose of take-off.

The charge includes the following distinct components:

- a) Safety and cleaning of the runway;
- b) Removal of objects;
- c) Fire and ambulance services;
- d) Meteorological services provided to aviation;
- e) Service for the approval of time or period of slots.

Airline operators are required to pay the landing and take-off charge for landing and take-off operations at the Republic of Cabo Verde airports and aerodromes.

The landing charge for the fully coordinated and facilitated airports of **GVAC, GVBA and GVNP**, will be of **876 CVE** per TON as per MTOW in the Certificate of Airworthiness, rounded up to the nearest TON.

For the remaining airports and aerodromes (**GVSV, GVSF, GVMA, GVSN**), the landing charge will be 705 CVE per TON as per MTOW in the Certificate of Airworthiness, rounded up to the nearest TON.

#### 4.1.2. Parking, hangar age and long - term storage of aircraft

##### 4.1.2.1 Parking of aircraft

The parking charge is a counterpart for the provision of airport service for each aircraft parking operation at the Republic of Cabo Verde airport and aerodromes.

The charge includes the following distinct components:

- a) Services provided for the movement of the aircraft;
- b) Maintenance of the appropriate spaces for aircraft parking.

Airlines operators operating on parking at the Republic of Cabo Verde airport and aerodromes are required to pay the parking charge.

A charge of 8.46 CVE is to be paid for each aircraft in parking operation, per hour or fraction and for each metric ton of the maximum take - off weight indicated in the Certificate of Airworthiness or in equivalent document, of the aircraft.

##### 4.1.2.2 Hangarage charges

NIL

##### 4.1.2.3 Long term storage

NIL

#### 4.1.3. Passenger service

The passenger service charge is a counterpart for the service provided to air transport passengers at the Republic of Cabo Verde airports and aerodromes.

The passenger charge includes the following distinct components:

- a) Public areas and passenger waiting rooms with air condition, lighting, bathroom services, access routes, circulation and signalling;
- b) Areas necessary for the provision of ground handling services (check - in, baggage and cargo processing, lost and found);
- c) Cleaning and maintenance service;
- d) Flight information panels;
- e) Offices for support services;
- f) Service for Persons with Reduced Mobility (PMR).

The passenger charge is payable for each passenger who embarks at national aerodromes, either on domestic flights or on international flights.

The passenger charge is still due if the ticket holder does not board within one year, or within the period of validity that results from the contractual conditions of the ticket, as from the date of issue or reissue of the same.

The passenger rate for international travel is fixed at 1740 CVE and the passenger rate on national travel is 600 CVE.

**Note:** Rates to be invoiced directly to the operator concerned. This charge be collected from the passenger separately.

#### 4.1.4. Security

TSA is the counterpart for the services provided to air passengers,

TSA comprises the following distinct components:

- a) Passenger and hand luggage control;
- b) Mail and cargo control;
- c) Control of staff at aerodromes, airports and airlines;
- d) Aircraft, surveillance and security restricted areas;
- e) Control of personnel with access to security restricted areas;
- f) Aerodromes identification systems;
- g) Staff training;
- h) Implementation of the National Civil Aviation Security Quality control Program;
- i) Support for security activities carried out by entities with responsibility for civil aviation security.

TSA is due for each passenger who embarks on national aerodromes, both on domestic flights and on international flights.

TSA is still due if the passenger does not board within one year, or within the validity period that results from the contractual conditions of the ticket, counted from the date of issue or reissue of the same.

The value of the TSA is fixed at 3400 CVE for international flights and 150 CVE for domestic flights.

**Note:** This charge shall be collected by the airports and aerodromes managing entity directly from the passenger or through air carriers and their agents when issuing the travel document and must be clearly identified in that.

#### 4.1.5. Noise - related item

Not applicable.

#### 4.1.6. Other

Airline operators using airport services are required to pay the aircraft removal charge.

##### 4.1.6.1 Catering charges

Catering charges are for the supply of consumer products at aerodromes and airports (as a percentage of the cost of products and charged together with that cost).

For each aircraft removal operation at aerodromes and airports, a rate of 470 CVE is due.

A rate of 10% of the total amount charged by the catering.

The charge will be paid by the enterprise which provides the catering operation.

##### 4.1.6.8 Sound information

The sound information charge constitutes a counterpart for the provision of the sound services at the aerodromes and airports.

##### 4.1.6.2 Aircraft Handling Service Charge

A rate of 10% of the total amount charged by the catering operator is due to each handling operation rendered by an enterprise to any commercial air transport aircraft.

Aircraft operators operating on the country's aerodromes and airports are required to pay the sound information charge.

For each sound information service operation at the aerodromes and airports, a rate of 160 CVE is due.

##### 4.1.6.3 Fire brigade to aircraft refuelling

The fire brigade to aircraft refuelling charge is the counterpart for the services of supervision and assistance of airport refuelling services to aircraft with passengers on board.

##### 4.1.6.9 Ground handling

###### 4.1.6.9.1 Check - in counter usage

Air operators using airport services are required to pay the refuelling with passengers on board charge.

The fee for using check - in counters is offset using physical infrastructure at the aerodromes and airports.

The ground handling service providers who use airport services are required to pay the fee for using check - in counters.

A rate of 1880 CVE is to be paid for each 15 minutes of assistance by fire brigade to aircraft refuelling with passengers on board.

For each hour or fraction of use check - in counter equipment, a check - in counter use fee of 950 CVE is due.

##### 4.1.6.4 Lighting aids

The lighting aids charge is a counterpart for the provision of airport services for landing or take - off operations in which lighting aids are used, either in cases where it is mandatory or when requested by the aircraft.

###### 4.1.6.9.2 Passenger processing

The passenger processing charge is compensated using the CUPP system (Common Use Passenger Processing System) by the ground handling service providers in the processing of passengers in the terminal or even outside the terminal, namely in ports or hotels.

Air operators using airport services are required to pay the lighting aids charge.

Passenger processing service providers using airport services at aerodromes and airports are required to pay the passenger processing charge.

For each landing or take - off operation of the aircraft, as indicated in the certificate of airworthiness or equivalent document, lighting aids rate of 9400 CVE is due.

For each passenger processing in the CUPPS system, a fee of 50 CVE is due.

##### 4.1.6.5 Cargo

The cargo charge is the counterpart for the supervision of airport services, considering the cargo loaded and unloaded, separately from the baggage.

#### 4.1.7. Exemptions / Reductions

##### 4.1.7.1 Exemptions

###### 4.1.7.1.1 Landing of aircraft

Airline operators using airport are required to pay the cargo charge.

The following are exempt from landing and take - off charge:

For each kilogram of cargo shipped, a rate of 1 CVE is due and for each kilogram of cargo landed, a rate of 2 CVE is due.

- a) The operations carried out in an exclusive transport service of Heads of State or Government, as well as ministers, on official travel, whenever, in any of these cases, the respective status is indicated in the flight plan, under agreements of reciprocity of treatment, after confirmation by the services of the Ministry of Foreign Affairs in terms of their competence in the matter;
- b) Operations carried out by military or other aircraft, on an official mission, under special agreements binding the Republic of Cabo Verde, after confirmation by the services of the Ministry of Foreign Affairs or the Ministry of National Defence, as the case may be, in the terms of their respective competences;
- c) Aircraft in search and rescue operations, in humanitarian, scientific missions or in service of the entity providing air navigation services or the managing entity of aerodromes;
- d) Aircraft that make landings for reasons of forced return to the aerodrome, justified by reasons of a technical or meteorological nature or another force majeure, duly proven, when they have not used another aerodrome.

##### 4.1.6.6 Signalling

The signalling charge is a counterpart for the provision of airport services for aircraft signalling operations at aerodromes and airports.

Airline operators using airport services are required to pay the signalling charge.

For each aircraft signalling operation, a signalling charge of 470 CVE is due.

##### 4.1.6.7 Aircraft removal

The aircraft charge constitutes a counterpart for the aircraft removal operations on the runway of the aerodromes and airports.

#### 4.1.7.1.2 Parking

The following are exempt from parking:

- a) The operations carried out in an exclusive transport service of Head of State or Government, as well as ministers, on official travel, whenever, in any of these cases, the respective status is indicated in the flight plan, under agreements of reciprocity of treatment, after confirmation by the services of the Ministry of Foreign Affairs in term of their competence in the matter;
- b) Operations carried out by military or other aircraft, on an official military mission, under special agreements binding the Republic of Cabo Verde, after confirmation by the services of the Ministry of Foreign Affairs or the Ministry of National Defence, as the case may be, in the terms of their respective competences;
- c) Aircraft in search and rescue operations, in humanitarian, scientific missions or in service of the entity providing air navigation services or the managing entity of aerodromes;
- d) Aircraft that make landings for reasons of forced return to the aerodrome, justified by reasons of a technical or meteorological nature or another force majeure, duly proven, when they have not used another aerodrome.
- e) Aircraft in regular or continuous series of non - regular operations during the first 60 (sixty) minutes of parking are also exempt from the parking charge.

#### 4.1.7.1.3 Passenger service

The following are exempt from passenger service charge on traveling nationally and internationally:

- a) Children under 2 (two) years of age;
- b) Passengers who, including on official missions, embark on aircraft for the private service of the Republic of Cabo Verde or Foreign State, on a reciprocal basis;
- c) Passengers on aircraft that make landings due to force return to aerodromes or airports, justified by reasons of a technical or meteorological nature or other force majeure, duly proven when other aerodromes or airports have not been used;
- d) Passengers in transit at national aerodromes.

#### 4.1.7.1.4 Security

The following are exempt from TSA payment:

- a) Children under 2 (two) years of age;
- b) Passengers who, including on official missions, disembark in aircraft for the private service of the Republic of Cabo Verde or Foreign State, on a reciprocal basis;
- c) Passengers on aircraft that land by reason of force return to the aerodrome, justified by reasons of a technical or meteorological nature or other force majeure, duly proven when they have used another aerodromes;
- d) Passengers in transit at national aerodromes.
- e) Republic of Cabo Verde passport holders on international flights.

#### 4.1.7.2 Reductions

##### 4.1.7.2.1 Landing of aircraft

Benefit from the following reductions in the landing and take - off rate

- a) 60% reduction on Cabo Verde aircraft on local experience flights, material testing, instruction, verification, training or examination of aircrew;
- b) 40% reduction on commercial aircraft on internal flights.

##### 4.1.7.2.2 Parking

Aircraft normally based on a given airport or aerodrome benefit from the following reductions in the parking fee at that aerodrome when parking for more that six hours:

- a) 50% for each metric ton of aircraft with a maximum take - off weight of up to 25 metric ton;
- b) 40% for each metric ton of aircraft with a maximum take - off weight greater than 25 metric ton.

##### 4.1.7.2.3 Passenger service

A 50% reduction in the rate of passenger service on national and international travel for children aged between 2 (two) to 12 (twelve) years of age.

#### 4.1.8. Methods of payment

4.1.8.1 Landing charges and parking or hangar charges levied at daily rates are payable at the time the aerodrome is used or, in case of the regular users, on demand at the end of each calendar month in respect of charges accruing during the month.

4.1.8.2 The following Credit Cards: VISA, Master Card, Diners Club and American Express:

- a) VISA, Master Card, Diners Club and American Express

- Sal Island / Amilcar Cabral Airport (GVAC)
- Praia / Nelson Mandela Airport (GVNP)

- b) VISA, Master Card and American Express:

- Sao Pedro / Cesaria Evora Airport (GVSV)
- Rabil / Aristides Pereira Airport (GVBA)

**INTENTIONALLY LEFT BLANK**

## GEN 4.2 AIR NAVIGATION SERVICES CHARGES

### 4.2.1. Approach Control

The Terminal Area Navigation Charge (TNC) is a counterpart for the provision of air navigation services, for each air traffic control operation for the approach and landing of national or foreign aircraft.

Air operators in approach and landing operations at aerodromes and airport are required to pay the terminal navigation charge.

The terminal air navigation charge is applied for each aircraft in an approach and landing operation, directly its maximum take - off weight, according to the following table:

MTOW	CHARGES IN CVE
Up to 10 tonnes	2500
> 10 up to 25 tonnes	3500
> 25 up to 129 tonnes	12500
> 129 tonnes	20000

### 4.2.2. Route Air Navigation Services

Air navigation charge en - route in the SAL OCENIC FIR / UIR is a counterpart for the provision of air traffic control air navigation services to air operator overflying the space managed by the Republic of Cabo Verde.

Airline operators that use the SAL OCENIC FIR / UIR in their operation are required to pay the air navigation en - route charge.

The en - route air navigation charge is applied to each aircraft using the SAL OCENIC FIR / UIR, considering the maximum take - off weight bands (rounded up), the distance segments and the charging coefficients.

The charge relative to each flight will be determined by multiplying the respective flight coefficient by a unit rate of 2300 CVE. The flight coefficient is determined from the maximum take - off weight and the total distance flown in SAL OCENIC FIR / UIR as per the table below:

<i>En - route Charges - Coefficient Determination</i>			
	Service unit rate: 2300 CVE		
Maximum take - off weight	Distance (KM)		
	<700	700 - 1000	>1000
	Flight Coefficient		
<5 tonnes	0.5	1	1.5
5 - 19 metric ton	1	2	3
20 - 49 metric ton	2	4	8
50 - 139 metric ton	3	6	12
140 - 199 metric ton	10	20	40
200 - 269 metric ton	14	28	56
270 - 349 metric ton	18	36	72
350 - 439 metric ton	22	44	88
>440 metric ton	25	50	100

### 4.2.3. Cost basis for Air Navigation Services and exemptions / reductions

#### 4.2.3.1 Exemptions

##### 4.2.3.1.1 Approach control

The following are exempt from Terminal Air Navigation Charges:

- The operations carried out in an exclusive transport service of Heads of State or Government, as well as ministers, on official travel, whenever, in any of these cases, the respective status is indicated in the flight plan, under agreements of reciprocity of treatment, after confirmation by the services of the Ministry of Foreign Affairs in terms of their competence in the matter;
- Operations carried out by military or other aircraft, on an official military mission, under special agreements binding the Republic of Cabo Verde, after confirmation by the services of the Ministry of Foreign Affairs or the Ministry of National Defence, as the case may be, in the terms of their respective competences;
- Aircraft in search and rescue operations, in humanitarian, scientific missions or in service of the entity providing air navigation services or the managing entity of aerodromes;
- Aircraft that make landings for reasons of forced return to the aerodrome, justified by reasons of technical or meteorological nature or another majeure, duly proven, when they have not used another aerodrome.

##### 4.2.3.1.2 Reductions

Not applicable.

### 4.2.4. Methods of Payment

4.2.4.1 The International Air Transport Association (IATA) will undertake billing and collection of the Terminal Area Navigation (TNC) and En - route Air Navigation Charges on behalf of ASA - Aeroportos e Seguranca Aerea - S.A., except for users of Republic of Cabo Verde airports on occasional / non - scheduled flights that will be invoiced and charges collected by ASA - Aeroportos e Seguranca Aerea - S.A. at the respective aerodrome before departure.

4.2.4.2 Users of Republic of Cabo Verde airports on domestic flights will be invoiced and Terminal Area Navigation Charges (TNC) collected directly by ASA - Aeroportos e Seguranca Aerea - S.A..

4.2.4.3 The following credit cards will be accepted:

VISA, Master Card, Diners Club and American Express:

- Sal Island / Amilcar Cabral Airport (GVAC)
- Praia / Nelson Mandela Airport (GVNP)

VISA, Master Card and American Express:

- Sao Pedro / Cesaria Evora Airport (GVSV)
- Rabil / Aristides Pereira Airport (GVBA)

**INTENTIONALLY LEFT BLANK**

**PART 2 - EN-ROUTE (ENR)**

**ENR 0.**

**ENR 0.1 TABLE OF CONTENT TO PART 2**

	<i>Page</i>
<b>ENR 0.</b>	
ENR 0.1 TABLE OF CONTENT PART 2 .....	GEN 0.1-1
<b>ENR 1. GENERAL RULES AND PROCEDURES</b>	
ENR 1.1 GENERAL RULES .....	ENR 1.1-1
ENR 1.2 VISUAL FLIGHT RULES .....	ENR 1.2-1
ENR 1.3 INSTRUMENT FLIGHT RULES .....	ENR 1.3-1
ENR 1.4 ATS AIRSPACE CLASSIFICATION AND DESCRIPTION .....	ENR 1.4-1
ENR 1.5 HOLDING, APPROACH AND DEPARTURE PROCEDURES .....	ENR 1.5-1
ENR 1.6 ATS SURVEILLANCE SERVICE AND PROCEDURES .....	ENR 1.6-1
ENR 1.7 ALTIMETER SETTING PROCEDURES .....	ENR 1.7-1
ENR 1.8 REGIONAL SUPPLEMENTARY PROCEDURES (ICAO DOC 7030) .....	ENR 1.8-1
ENR 1.9 AIR TRAFFIC FLOW MANAGEMENT (ATFM) AND AIRSPACE MANAGEMENT .....	ENR 1.9-1
ENR 1.10 FLIGHT PLANNING .....	ENR 1.10-1
ENR 1.11 ADDRESSING OF FLIGHT PLAN MESSAGES .....	ENR 1.11-1
ENR 1.12 INTERCEPTION OF CIVIL AIRCRAFT .....	ENR 1.12-1
ENR 1.13 UNLAWFUL INTERFERENCE .....	ENR 1.13-1
ENR 1.14 AIR TRAFFIC INCIDENTS .....	ENR 1.14-1
<b>ENR 2. AIR TRAFFIC SERVICES AIRSPACE</b>	
ENR 2.1 FIR, UIR, TMA AND CTA .....	ENR 2.1-1
ENR 2.2 OTHER REGULATED AIRSPACE .....	ENR 2.2-1
<b>ENR 3. ATS ROUTES</b>	
ENR 3.1 LOWER ATS ROUTES .....	ENR 3.1-1
ENR 3.2 UPPER ATS Routes .....	ENR 3.2-1
ENR 3.3 AREA NAVIGATION (RNAV) ROUTES .....	ENR 3.3-1
ENR 3.4 HELICOPTER ROUTES .....	ENR 3.4-1
ENR 3.5 OTHER ROUTES .....	ENR 3.5-1
ENR 3.6 EN-ROUTE HOLDING .....	ENR 3.6-1
<b>ENR 4. RADIO NAVIGATION AIDS/SYSTEMS</b>	
ENR 4.1 RADIO NAVIGATION AIDS - EN-ROUTE .....	ENR 4.1-1
ENR 4.2 SPECIAL NAVIGATION SYSTEMS .....	ENR 4.2-1
ENR 4.3 GLOBAL NAVIGATION SATELLITE SYSTEM (GNSS) .....	ENR 4.3-1
ENR 4.4 NAME - CODE DESIGNATORS FOR SIGNIFICANT POINTS .....	ENR 4.4-1
ENR 4.5 AERONAUTICAL GROUND LIGHTS - EN-ROUTE .....	ENR 4.5-1
<b>ENR 5. NAVIGATION WARNINGS</b>	
ENR 5.1 PROHIBITED, RESTRICTED AND DANGER AREAS .....	ENR 5.1-1
ENR 5.2 MILITARY EXERCISE AND TRAINING AREAS AND AIR DEFENCE IDENTIFICATION ZONE (ADIZ) .....	ENR 5.2-1
ENR 5.3 OTHER ACTIVITIES OF A DANGEROUS NATURE AND OTHER POTENTIAL HAZARDS .....	ENR 5.3-1
ENR 5.4 AIR NAVIGATION OBSTACLES - AREA 1 .....	ENR 5.4-1
ENR 5.5 AERIAL SPORTING AND RECREATIONAL ACTIVITIES .....	ENR 5.5-1
ENR 5.6 BIRD MIGRATION AND AREAS WITH SENSITIVE FAUNA .....	ENR 5.6-1
<b>ENR 6. EN-ROUTE CHARTS</b>	
EN-ROUTE CHART - SAL FIR UPPER AIRSPACE .....	ENR 6-1
EN-ROUTE CHART - SAL FIR LOWER AIRSPACE .....	ENR 6-2
EN-ROUTE CHART - SAL TMA .....	ENR 6-3

**INTENTIONALLY LEFT BLANK**



## ENR 1. GENERAL RULES AND PROCEDURES

### ENR 1.1 GENERAL RULES

The air traffic rules and procedures applicable to air traffic in SAL OCENIC FIR / UIR conform to ICAO Annexes 2 and 11 to the Convention on International Civil Aviation and to those portions of the Procedures for Air Navigation Services - Rules of the Air and Air Traffic Management applicable to aircraft and of the Regional Supplementary Procedures applicable to the SAM Region, except for the difference listed in **GEN 1.7**.

#### 1.1.1. Minimum Safe Heights

Aircraft shall not be flown below the minimum safe height except when necessary for the take - off and landing. The minimum safe height is the height at which neither an unnecessary noise disturbance nor unnecessary hazards to persons and property in the event of an emergency landing are to be feared; however, over cities, other densely populated areas and assemblies of persons, this height shall be at least 300 M (1000 FT) above the highest obstacle within a radius of 600 M, and elsewhere at least 150 M (500 FT) above ground or water. Gliders and balloons may be operated below a height of 150 M is necessary for the kind of operation and if danger to persons and property is not to be feared. Aircraft shall not be flown below bridges and similar constructions nor below overhead lines and antennas. For flight conducted for special purposes, the local aeronautical authority may grant exceptions.

#### 1.1.2. Dropping of objects

The dropping or spraying of objects or other substances out from aircraft is prohibited. This does not apply to ballast in the form of water or fine sand, fuel, tow ropes, tow banners and similar objects if dropped or discharged at places where no danger to persons or property exists. The local aeronautical authority may grant exemptions to the interdiction if no danger to persons or property exist. The dropping of mail is controlled by the Postal Authority or by the designated unit, in agreement with the aeronautical authority.

#### 1.1.3. Acrobatic flights

Acrobatic flights are only permitted in visual meteorological conditions and with the explicit consent of all persons on board. Acrobatic flights are prohibited at heights of less than 450 M (1500 FT) as well as over cities, other densely populated areas, assemblies of persons, and airports. The local aeronautical authority may grant exemptions in individual cases. Acrobatic flights conducted in the vicinity of aerodromes without an ATS unit require special permission in addition to the air traffic control clearance.

#### 1.1.4. Towing and advertising flights

1.1.4.1 Advertising flights with towed objects require permission from the local aeronautical authority in the area in which the applicant is a resident. Permission shall be granted only if:

- a) The pilot holds the rating for towing;
- b) The aircraft is equipped with a calibrated barograph for recording altitudes during flight;
- c) During the proposed flight not more than three aircraft are flying in formation, in which case a distance of at least 60 M shall be maintained both between the towed object of the preceding aircraft and the following aircraft, as well as between the aircraft;
- d) The legal liability insurance also explicitly covers the towing of objects.

1.1.4.2 The above applies to the towing of objects for other than advertising purposes and subparagraph does not apply to aerial work of rotorcraft. Towing gliders does not require permission, as the rating for towing will suffice. For reasons of public safety or order and in particular for noise abatement, the authority granting permission

may impose conditions. This authority may assign higher minimum safe heights and impose time limitations.

1.1.4.3 Advertising flights, where advertising consists only of inscriptions on the aircraft, do not require permission. Flights for advertising with acoustical means are prohibited.

#### 1.1.5. Times and units of measurement

Co - ordinated Universal Time (UTC) and the prescribed units of measurement shall be applied to flight operations. ASA - Aeroportos e Seguranca Aerea - S.A. - EP acting under delegated authority of the Minister of Infrastructure and Transport (Ministerial Resolution from 13th November 1995 published in "Boletim Oficial n° 45 - 1 serie" on 29th December 1995) will establish the units of measurement to be used and they will be published in the Aeronautical Information Publication (AIP).

#### 1.1.6. Airspace structure

For the performance of the flight information service and the alerting service, ASA - Aeroportos e Seguranca Aerea - S.A. establishes flight information regions which are published in the AIP. Within the flight information regions, ASA - Aeroportos e Seguranca Aerea - S.A. establishes the controlled and uncontrolled airspace according to the extent of air traffic service maintained there, on the basis of classification described in section **ENR 1.4**. Within controlled airspace, VFR flights may be prohibited completely or partly by the air traffic services with regard to the limitations of space and time if urgently required by the degree of intensity of air traffic subject to air traffic control.

#### 1.1.7. Prohibited areas and flight restrictions

ASA - Aeroportos e Seguranca Aerea - S.A., acting under delegated authority of the Minister of Infrastructure and Transport, establishes prohibited and restricted areas, if necessary, for the prevention of danger to public safety or order, especially for the safety of air traffic. The areas will be published in the AIP.

#### 1.1.8. Cloud flights with gliders

Cloud flights with gliders may be permitted by the air traffic services if the safety of air traffic can be maintained by appropriate measures. Conditions may be attached to the permission.

#### 1.1.9. Take - offs and landings of aeroplanes, rotorcraft, airships, powered gliders, gliders and parachutists outside aerodromes admitted for them

1.1.9.1 For take - offs and landings of aeroplanes, rotorcraft and airships, permission from the local authority is required. For take - offs of powered gliders and gliders outside designated aerodromes, permission from the local aeronautical authority is required; however, for landings of powered gliders and gliders on a cross - country flight, permission is not required. This is to be applied analogously to landings of parachutists outside designated aerodromes.

1.1.9.2 The authority granting permission may ask the applicant to produce evidence of the consent of the terrain owner or other entitled parties.

#### 1.1.10. Ascents of balloons, kites, self - propelled flying models and flying bodies

1.1.10.1 The ascent of a manned free balloon outside aerodromes admitted for balloon ascents requires permission from

the local aeronautical authority.

1.1.10.2 The ascent of captive balloons is permitted only with the content of the local aeronautical authority. For kites, this consent is required if they are held by a rope of more than 100 M (300 FT) in length. Kite ascent within the construction restricted zone of airports as well as within a distance of less than 3 KM from the boundary of airfields and gliding sites are prohibited. The local aeronautical authority may grant exemptions.

1.1.10.3 The mooring rope of captive balloons and kites, the ascent of which requires permission, shall be marked, at spacings of 100 M (300 FT) by red / white flags during the day, and by red and white lights at night, in such a manner that it is recognisable to other aircraft from all directions.

1.1.10.4 The ascent of flying models of less than 5 KG total weight requires no permission, with the exception of rocket - propelled models. The operation of flying models with combustion engines within a distance of less than 1.5 KM from housing areas is permitted only with the consent of the local aeronautical authority. The same applies to flying models of all types within a distance of less than 1.5 KM from the boundary of aerodromes. The operation of all types of flying models on aerodromes is permitted only with the consent of the air traffic services.

#### **1.1.11. Clearance before entering Class C airspace**

Within the SAL OCENIC FIR / UIR, all aircraft operating in Class G airspace intending to enter Class C airspace shall contact ATC and obtain clearance prior to enter Class C airspace.

#### **1.1.12. Requirements for read back of ATC clearance**

The flight crew shall read back to the air traffic controller safety related parts of ATC clearances and instructions which are transmitted by voice. The following items shall always be read back:

- a) ATC route clearances;
- b) Clearances and instructions to enter, land on, take - off from, hold short of, cross and back track on any runway;
- c) Runway in use, altimeter settings, SSR code, level instructions, heading and speed instructions, weather issued by controller or contained in ATIS broadcast and transition levels.

## ENR 1.2 VISUAL FLIGHT RULES

### 1.2.1. General

- b) No person may operate an aircraft under VFR when the flight visibility is less than, or at a distance from the clouds that is less than that prescribed, or the corresponding altitude and class of airspace in the following table:

#### 1.2.1.1 Visual Meteorological Conditions

- a) All aircraft operated in accordance with VFR flight procedures shall comply with the visual flight rules prescribed in this subsection.

#### Airspace and VMC Minima\*

Airspace class	A***BCDE		F G	
			ABOVE 900 M (3000 FT) or above 300 M (1000 FT) above terrain (AGL), whichever is the higher	At and below 900 M (3000 FT) or 300 M (1000 FT) above terrain (AGL), whichever is the higher
Distance from cloud		1500 M horizontally 300 M (1000 FT) vertically	Clear of cloud and in sight of the surface	
Flight visibility	8 KM at and above 3050 M (10000 FT) 5 KM below 3050 M (10000 FT)		5 KM**	

\* When the height of the transition altitude is lower than 3050 M (10000 FT), FL 100 should be used in lieu of 10000 FT.

\*\* When so prescribed by the appropriate ATS authority, lower flight visibilities to 1500 M may be permitted for flights operating:  
1) At speeds that, in the prevailing visibility, will give adequate opportunity to observe other traffic or any obstacles in time to avoid collision; or  
2) In circumstances in which the probability of encounters with other traffic would normally be low, e.g. in areas of low volume traffic and for aerial work at low levels  
Helicopters may be permitted to operate in less than 1500 M flight visibility, if manoeuvred at a speed that will give adequate opportunity to observe other traffic or any obstacles in time to avoid collision.

\*\*\* The VMC minima in Class A airspace are included for guidance to pilots and do not imply acceptance of VFR flights in Class A airspace.

1.2.1.2 Except when necessary for take - off or landing, or except by permission from the appropriate authority, a VFR flight shall not be flown:

- Over the congested areas of cities, towns or settlements, or over open - air assembly of persons at a height of less than 300 M (1000 FT) above the highest obstacle within a radius of 600 M from the aircraft.
- Elsewhere than as specified in a), at a height less than 150 M (500 FT) above the ground or water.

1.2.1.3 Except where otherwise indicated in air traffic control clearances or specified by the appropriate ATS authority, VFR flight in level when operated above 900 M (3000 FT) from the ground or water, or a higher datum as specified by the appropriate ATS authority, shall be conducted at a flight level appropriate to the track as specified in the tables of cruising levels.

1.2.1.4 VFR flights shall comply with the provision of paragraph 3.6 of ICAO Annex 2:

- When operating within Classes B, C and D airspace;
- When forming part of aerodrome traffic at controlled aerodromes; or
- When operated as special VFR flights.

1.2.1.5 An aircraft operated in accordance with the visual flight rules which wishes to change to compliance with the instrument flight rules shall:

- If a flight plan was submitted, communicate the necessary changes to be effected to its current flight plan; or
- When so required by paragraph ICAO Annex 2 paragraph 3.3, submit a flight plan to the appropriate air traffic services unit and obtain a clearance prior to proceeding IFR.

1.2.1.6 For the provision of FIS, VFR traffic shall:

- Submit a FPL (in person, by fax or telephone) or AFIL;
- Maintain continuous two - way radio communication;
- Be equipped and maintain in operation SSR Transponder.

### 1.2.2. VFR Weather Minima for Take - off and Landing

1.2.2.1 Except when a clearance is obtained from ATC, no person may land or take - off an aircraft under VFR from an aerodrome located within a control zone, or enter the aerodrome traffic zone (ATZ) or traffic pattern airspace, unless the:

- Reported ceiling is at least 450 M (1500 FT); and
- Reported ground visibility is at least 5 KM, if reported.

1.2.2.2 No person may land or take - off an aircraft or enter the traffic pattern under VFR from an aerodrome located outside a control zone, unless VMC conditions are at or above those indicated in 1.2.1.1 (VISUAL METEOROLOGICAL CONDITIONS).

1.2.2.3 The only exception to the required weather minima of this subsection is during a Special VFR operation.

### 1.2.3. Special VFR Operations

1.2.3.1 No person may conduct a Special VFR flight operation to enter traffic pattern, land or take - off an aircraft under special VFR from an aerodrome located in Class B, Class C, Class D or Class E airspace unless:

- Authorized by an ATC clearance;
- The aircraft remains clear of clouds; and
- The flight visibility is at least 1600 M.

1.2.3.2 No person may conduct a Special VFR flight operation in an aircraft between sunset and sunrise unless the:

- The PIC is current and qualified for IFR operations; and
- The aircraft is qualified to be operated for IFR flight.

### 1.2.4. VFR Cruising Altitudes

See table of cruising levels in ENR 1.7.5.

#### 1.2.5. ATC Clearances for VFR Flights

Each pilot of a VFR flight shall obtain and comply with ATC clearances and maintain a listening watch before and during operations:

- a) Within Classes B, C and D airspace;
- b) As part of aerodrome traffic at controlled aerodromes; and
- c) Under Special VFR.

#### 1.2.6. VFR Flights requiring ATC Authorisation

Unless authorized by the appropriate ATC authority, no pilot may operate in VFR flight:

- a) Above FL 200; or
- b) At transonic and supersonic speeds.

*Note: ATC authorisation for VFR flights may not be granted in areas where a vertical separation minimum of only 300 M (1000 FT) is applied above FL 290.*

#### 1.2.7. Weather deteriorating below VMC

Each pilot of a VFR flight operated as a controlled flight shall, when he or she finds it is not possible to maintain flight in VMC in accordance to ATC flight plan:

- a) Request and amended clearance enabling the aircraft to continue in VMC to its destination or top an alternate aerodrome or to leave the airspace within which an ATC clearance is required;
- b) If no clearance can be obtained, continue to operate in VMC and notify appropriate ATC facility of the action being taken either to leave the airspace concerned or to land at the nearest suitable aerodrome;
- c) If operating within a control zone, request authorisation to operate as a Special VFR flight; or
- d) Request clearance to operate in IFR, if currently rated for IFR operations.

#### 1.2.8. Changing from VFR to IFR

Each pilot operating in VFR who wishes to change IFR shall:

- a) If a flight plan was submitted, communicate the necessary changes to be effected to its current flight plan; or
- b) Submit a flight plan to the appropriate ATC facility and to obtain a clearance prior to proceeding IFR when in controlled airspace.

#### 1.2.9. Two - way Radio Communication Failure in VFR

If radio failure occurs in VFR while under ATC control, or if VFR conditions are encountered after the failure, each pilot shall:

- a) Continue the flight under VFR;
- b) Land at nearest suitable aerodrome; and
- c) Report arrival to ATC by the most expeditious means possible.

## ENR 1.3 INSTRUMENT FLIGHT RULES

### 1.3.1. Rules applicable to all IFR flights

#### 1.3.1.1 Aircraft equipment

Aircraft shall be equipped with suitable instruments and with navigation equipment appropriate to the route to be flown.

#### 1.3.1.2 Minimum levels

Except when necessary for take-off or landing or when specifically authorised by the appropriate authority, an IFR flight shall be flown at a level that is not below the minimum flight altitude established by the State whose territory is over flown, or where no such minimum flight altitude has been established:

1.3.1.2.1 Over high terrain or in mountainous areas, at a level which is at least 600 M (2000 FT) above the highest obstacle located within 8 KM of the estimated position of the aircraft;

1.3.1.2.2 Elsewhere than as specified in 1.3.1.2.1 above, at a level which is at least 300 M (1000 FT) above the highest obstacle located within 8 KM of the estimated position of the aircraft.

**Note:** *The estimated position of the aircraft will take account of the navigational accuracy which can be achieved on the relevant route segment, having regard to the navigational facilities available on the ground and in the aircraft.*

#### 1.3.1.3 Change from IFR flight to VFR flight

1.3.1.3.1 An aircraft electing to change the conduct of its flight from compliance with the instrument flight rules to compliance with the visual flight rules shall, if a flight plan was submitted, notify the appropriate air traffic services unit specifically so that the IFR flight can be cancelled and communicate thereto the changes to be made to its current flight plan.

1.3.1.3.2 When an aircraft operating under the instrument flight rules is flown in or encounters visual meteorological conditions, it shall not cancel its IFR flight unless it is anticipated, and intended, that the flight will be continued for a reasonable period of time in uninterrupted visual meteorological conditions.

### 1.3.2. Rules applicable to IFR flights within controlled airspace

1.3.2.1 IFR flights shall comply with ICAO Annex 2 paragraph 3.6 to the Convention on International Civil Aviation when operated in controlled airspace.

1.3.2.2 An IFR flight operating in cruising flight in controlled airspace shall be flown at a cruising level, or, if authorised to employ cruise climb techniques, between two levels or above a level, selected from:

- a) The table of cruising levels in ICAO Annex 2 Appendix 3, or
- b) a modified table of cruising levels, when so prescribed in accordance with ICAO Annex 2 Appendix 3 for flight above FL 410,

except that the correlation of levels to track prescribed therein shall not apply whenever otherwise indicated in air traffic control clearances or specified by the appropriate ATS authority in the Aeronautical Information Publication (AIP).

### 1.3.3. Rules applicable to IFR flights outside controlled airspace

#### 1.3.3.1 Cruising levels

An IFR flight operating in level cruising flight outside of controlled airspace shall be flown at a cruising level appropriate to its track as specified in:

- a) the table of cruising levels in ICAO Annex 2 Appendix 3, except when otherwise specified by the appropriate ATS authority for flight at or below 900 M (3000 FT); or
- b) a modified table of cruising levels, when so prescribed in accordance with of ICAO Annex 2 Appendix 3 for flight above FL 410.

**Note:** *This provision does not preclude the use of cruise climb techniques by aircraft in supersonic flight.*

#### 1.3.3.2 Communications

An IFR flight operating outside controlled airspace but within or into areas, or along routes, designated by the appropriate ATS authority in accordance with ICAO Annex 2 paragraph 3.3.1.2 c) or d) shall maintain a listening watch on the appropriate radio frequency and establish two-way communication, as necessary, with the air traffic services unit providing flight information service.

#### 1.3.3.3 Position reports

An IFR flight operating outside controlled airspace is required by the appropriate ATS authority to:

- submit a flight plan, and
- maintain a listening watch on the appropriate radio frequency and establish two-way communication, as necessary, with the air traffic services unit providing flight information service, shall report position as specified in ICAO Annex 2 paragraph 3.6.3 for controlled flights.

### 1.3.4. Reduced Vertical Separation Minima (RVSM)

#### 1.3.4.1 Area of Application

The airspace within the SAL OCENIC FIR / UIR between FL 290 and FL 410 inclusive, as described in **ENR 2.1** is RVSM airspace. Within this airspace, the vertical separation minimum shall be 300 M (1000 FT) between RVSM approved aircraft.

#### 1.3.4.2 Operations within RVSM Airspace

Only aircraft with RVSM approval will be authorised to operate within RVSM airspace.

#### 1.3.4.3 RVSM Approval

RVSM approved aircraft are those that have been approved by the State of Registry or State of the Operator, as appropriate, to conduct flights in RVSM airspace and that are capable of meeting the minimum aircraft system performance specification (MASPS) height - keeping requirements (or equivalent).

#### 1.3.4.4 Wake Turbulence Procedures

1.3.4.4.1 An aircraft operating in RVSM airspace encountering wake turbulence should notify ATC and request a revised clearance. However, in situations where a revised clearance is not possible or

practicable:

- a) the pilot should establish contact with other aircraft, if possible, on the appropriate VHF inter - pilot air - to - air frequency, and
- b) one (or both) aircraft may initiate lateral offset(s) not to exceed 2 NM from the assigned route or track provided that:
  - i. as soon as practicable, the offsetting aircraft notify ATC that temporary lateral offset action has been taken and specify the reason for doing so, and
  - ii. the offsetting aircraft notify ATC when re - established on assigned route(s) or track(s).

1.3.4.4.2 ATC will consider suspending RVSM procedures within affected areas of SAL OCENIC FIR / UIR, when there are pilot reports of greater than moderate turbulence. Within areas where RVSM procedures are suspended, the vertical separation minimum between aircraft will be 2000 FT.

**1.3.4.5 Mandatory Pilot Reports**

Except in the ADS or Radar environment, in addition to reading back altitude assignments, pilots shall report reaching any altitude assigned within RVSM airspace.

**1.3.4.6 ACAS**

If ACAS (TCAS) is installed in RVSM compliant aircraft, the equipment should be updated to Version 7, or later approved version, for optimum performance in RVSM airspace.

**1.3.4.7 Cruising levels**

1.3.4.7.1 The cruising levels that will apply within SAL OCENIC FIR / UIR RVSM airspace are those prescribed in Annex 2, Appendix 3, except for ATS routes UN 741 and UN 866 as specified in 1.3.4.7.2.2.

Track from 180° to 359°	Track from 000° to 179°
(outside RVSM airspace)	
	FL 410 ----->
<----- FL 400	
	FL 390 ----->
<----- FL 380	
	FL 370 ----->
<----- FL 360	
	FL 350 ----->
<----- FL 340	
	FL 330 ----->
<----- FL 320	
	FL 310 ----->
<----- FL 300	
	FL 290 ----->
	(Outside RVSM airspace)

1.3.4.7.2 In relation with the implementation of the RVSM in the CAR / SAM Regions and with the implementation of a new traffic orientation on ATS Routes UN 741 and UN 866, and in order to avoid flights in opposite directions at the same flight level, a new flight level allocation scheme has been established in the EUR / SAM corridor, as follows:

**1.3.4.7.2.1 ATS Routes: UN 873 and UN 857**

- a) **Southbound traffic: even levels** - 400, 380, 360, 340, 320, 300

- b) **Northbound traffic: odd levels** - 410, 390, 370, 350, 330, 310, 290

**1.3.4.7.2.2 ATS routes: UN 741 and UN 866 - Unidirectional Routes**

- a) **UN 741 - Southbound traffic: even and odd levels** to be indistinctly used
- b) **UN 866 - Northbound traffic: even and odd levels** to be indistinctly used

1.3.4.7.2.3 Operators are requested to plan their flights under this flight level allocation scheme.

**1.3.4.8 Random Traffic**

1.3.4.8.1 Due to implementation of automatic Data Exchange for Coordination between Sal ACC and Santa Maria ACC, all flights crossing the common FIR boundary Sal Oceanic / Santa Maria and vice versa, are required to do so via the entry / exit compulsory reporting points (i.e. **ULTEM, BAMUX, ERNEK, TEGTO, OBOMO, RUKAV, VEPPOP and XIBOT**), published in both in the Republic of Cabo Verde and Portugal AIP.

1.3.4.8.2 Procedures using entry / exit way points in random area on west of UN 741 into Dakar and Sal ACC's border and its mixture with the use of geographical coordinates:

For a better air traffic management by Dakar Oceanic and Sal ACC's, all aircraft not equipped with ADS - C / CPDLC, crossing common FIR boundary Dakar Oceanic / Sal Oceanic and vice versa on west of UN 741 shall overfly the entry / exit compulsory reporting points established along that boundary. However, the use of any entry / exit way points, based on geographical coordinates is allowed for ADS - C / CPDLC equipped aircraft. The implementation of these provisions will also help pilots to use most suitable routes.

## ENR 1.4 ATS AIRSPACE CLASSIFICATION AND DESCRIPTION

### 1.4.1. ATS airspace classification

ATS airspaces are classified and designated in accordance with the following:

*Class A.* IFR flights only are permitted, all flights are subject to air traffic control service and are separated from each other.

*Class B.* IFR and VFR flights are permitted, all flights are subject to air traffic control service and are separated from each other.

*Class C.* IFR and VFR flights are permitted, all flights are subject to air traffic control service and IFR flights are separated from other IFR flights and from VFR flights. VFR flights are separated from IFR flights and receive traffic information in respect of other VFR flights.

*Class D.* IFR and VFR flights are permitted and all flights are subject to air traffic control service, IFR flights are separated from other IFR flights and receive traffic information in respect of VFR flights, VFR flights receive traffic information in respect of all other flights.

*Class E.* IFR and VFR flights are permitted, IFR flights are subject to air traffic control service and are separated from other IFR flights. All flights receive traffic information as far as is practical.

*Class F.* IFR and VFR flights are permitted, all participating IFR flights receive an air traffic advisory service and all flights receive flight information service if requested.

*Class G.* IFR and VFR flights are permitted and receive flight information service if requested.

The requirements for the flights within each class of airspace are as shown in the following table.

**Table 1.4.1: ATS Airspace Classifications (Controlled)**

Class	Type of flight	Separation provided	Service provided	VMC visibility and distance from cloud minima	Speed limitation*	Radio communication requirement	ATC clearance
<b>A</b>	IFR only	All aircraft	Air traffic control service	Not applicable	Not applicable	Continuous two-way	Yes
<b>B**</b>	IFR	All aircraft	Air traffic control service	Not applicable	Not applicable	Continuous two-way	Yes
	VFR	All aircraft	Air traffic control service	8 KM at and above 3050 M (10 000 FT) AMSL, 5 KM below 3050 M (10000 FT) AMSL Clear of clouds	Not applicable	Continuous two-way	Yes
	IFR	IFR from IFR, IFR from VFR	Air traffic control service	Not applicable	Not applicable	Continuous two - way	Yes
<b>C</b>	VFR	VFR from IFR	1. Air traffic control service for separation from IFR 2. VFR / VFR traffic information (and traffic avoidance advice on request)	8 KM at and above 3050 M (10000FT) AMSL, 5 KM below 3050M (10000 FT) AMSL 1500 M horizontal; 300 M vertical distance from cloud	250 KT IAS below 3050 M (10000 FT) AMSL	Continuous two-way	Yes
<b>D**</b>	IFR	IFR from IFR	Air traffic control service including traffic information about VFR flights (and traffic avoidance advice on request)	Not applicable	250 KT IAS below 3050 M (10000 FT) MSL	Continuous two-way	Yes
	VFR	Nil	Traffic information between VFR and IFR flights (and traffic avoidance advice on request)	8 KM at and above 3050 M (10000 FT) AMSL, 5 KM below 3050 M (10000 FT) AMSL 1500 M horizontal; 300 M vertical distance from cloud	250 KT IAS below 3050 M (10000 FT) AMSL	Continuous two-way	Yes
Class E**	IFR	IFR from IFR	Air traffic control service and traffic information about VFR flights as far as practical	Not applicable	250 KT IAS below 3050 M (10000 FT) AMSL	Continuous two-way	Yes
	VFR	Nil	Traffic information as far as practical	8 KM at and above 3050 M (10000 FT) AMSL, 5 KM below 3050 M (10000 FT) AMSL 1500 M horizontal; 300 M vertical distance from cloud	250 KT IAS below 3050 M (10000 FT) AMSL	No	No

\* When the height of a transition altitude lower than 3050 M (10000 FT) AMSL, FL 100 should be used in lieu of 10000 FT.

\*\* Classes of airspace B, D and F are not used in SAL OCENIC FIR / UIR.

\*\*\* When so prescribed by the appropriate ATS authority:

- a) lower flight visibilities to 1500 M may be permitted for flights operating:
  - i. at speeds that, in the prevailing visibility, will give adequate opportunity to observe other traffic or any obstacles in time to avoid collision; or
  - ii. in circumstances in which the probability of encounters with other traffic would normally be low, e.g. in areas of low traffic volume and for aerial work at low levels.
- b) helicopters may be permitted to operate in less than 1500 M flight visibility, if manoeuvred at a speed that will give adequate opportunity to observe other traffic or any obstacles in time to avoid collision.



**Table 1.4.2: ATS airspace Classifications (Uncontrolled)**

Class	Type of flight	Separation provided	Service provided	VMC visibility and distance from cloud minima	Speed limitation*	Radio communication requirement	ATC clearance
F**	IFR	IFR from IFR as practical	Air traffic advisory service, flight information service	Not applicable	250 KT IAS below 3050 M (10000 FT) AMSL	Continuous two - way	No
	VFR	NIL	Flight Information Service	8 KM at and above 3050 M (10000 FT) AMSL, 1500 M horizontal; 300 M vertical distance from cloud. At and below 900 M AMSL or 300 M above terrain whichever is higher - 5 KM*** clear of cloud and in sight of ground or water.	250 KT IAS below 3050 M (10000 FT) AMSL	No	No
G	IFR	NIL	Flight Information Service	Not applicable	250 KT IAS below 3050 M (10000 FT) AMSL	Continuous two-way	No
	VFR	NIL	Flight Information Service	8 KM at and above 3050 M (10000 FT) AMSL, 5 KM below 3050 M (10000 FT) AMSL, 1500 M horizontal; 300 M vertical distance from cloud. At and below 900 M AMSL or 300 M above terrain whichever is higher - 5 KM***, clear of cloud and in sight of ground or water	250 KT IAS below 3050 M (10000 FT) AMSL	No	No

\* When the height of a transition altitude lower than 3050 M (10000 FT) AMSL, FL 100 should be used in lieu of 10000 FT.  
\*\* Classes of airspace B, D and F are not used in SAL OCENIC FIR / UIR.  
\*\*\* When so prescribed by the appropriate ATS authority:  
a) lower flight visibilities to 1500 M may be permitted for flights operating:  
i. at speeds that, in the prevailing visibility, will give adequate opportunity to observe other traffic or any obstacles in time to avoid collision; or  
ii. in circumstances in which the probability of encounters with other traffic would normally be low, e.g. in areas of low traffic volume and for aerial work at low levels.  
b) helicopters may be permitted to operate in less than 1500 M flight visibility, if manoeuvred at a speed that will give adequate opportunity to observe other traffic or any obstacles in time to avoid collision.

**INTENTIONALLY LEFT BLANK**

**ENR 1.5 HOLDING, APPROACH AND DEPARTURE PROCEDURES**

**1.5.1. General**

1.5.1.1 The holding, approach and departure procedures in use are based on those contained in the latest edition of ICAO Doc 8168 - Procedures for Air Navigation Services - Aircraft Operations (PANS-OPS).

1.5.1.2 The holding and approach procedures in use have been based on the values and factors contained in Parts III and IV of Vol. I of the PANS-OPS. The holding patterns shall be entered and flown as indicated below.

**1.5.2. Arriving flights**

1.5.2.1 IFR flights entering and landing within a terminal control area will be cleared to a specified holding point and instructed to contact approach control at a specified time, level or position. The terms of this clearance shall be adhered to until further instructions are received from approach control. If the clearance limit is reached before further instructions have been received, holding procedure shall be carried out at the level last authorized.

1.5.2.2 Due to the limited airspace available, it is important that the approaches to the patterns and the holding procedures be carried out as precisely as possible. Pilots are strongly requested to inform ATC if for any reason the approach and / or holding cannot be performed as required.

**1.5.3. Departing flights**

1.5.3.1 IFR flights departing from controlled aerodromes will receive initial ATC clearance from the local aerodrome control tower. The clearance limit will normally be the aerodrome of destination. IFR flights departing from non-controlled aerodromes must make

arrangements with the area control centre concerned prior to take-off.

1.5.3.2 Detailed instructions will be issued with regard to routes, turns, etc. will be issued after take - off.

**1.5.4. Other relevant information and procedures**

NIL

**1.5.5. Special procedures**

If necessary, in case of congestion, inbound aircraft may also be instructed to hold at one of the designated airways reporting points.

**1.5.6. Weather minima**

1.5.6.1 An approach - to - land as well as a landing clearance will be issued regardless of weather conditions.

1.5.6.2 If no visual contact is established at the OCH appropriate missed approach procedure shall be initiated.

1.5.6.3 There are no weather requirements for take - off, except that the pilot shall have sufficient visibility to continually align the aircraft with the axis of the runway.

1.5.6.4 Operators shall established their own meteorological minima for GVAC, GVNP, GVSV and GVBA aerodromes, and shall report them to ASA - Empresa Nacional de Aeroportos e Seguranca Aerea - S.A., Sal Island - Republic of Cabo Verde.

**1.5.7. Table of Transition Altitude and Levels**

Location	Transition Altitude (FT)	QNH (HPA)					
		942.2 to 959.4	959.5 to 977.1	977.2 to 995.0	995.1 to 1013.2	1013.3 to 1031.6	1031.7 to 1050.3
		TRANSITION LEVEL					
GVAC	7000	100	95	90	85	80	75
GVBA	7000	100	95	90	85	80	75
GVNP	7000	100	95	90	85	80	75
GVSV	7000	100	95	90	85	80	75

**INTENTIONALLY LEFT BLANK**

## ENR 1.6 ATS SURVEILLANCE SERVICES AND PROCEDURES

### PROVISION OF RADAR SERVICES WITHIN SAL FIR / UIR

#### 1.6.1. Introduction

A Traffic Control Services within SAL OCENIC FIR / UIR, with the exception of Aerodrome Control Service provided by TWR, will normally be carried out with the use of radar coverage. Many factors, such as radar coverage, controller workload, equipment capabilities, traffic density and the atmospheric conditions, may affect the performance of the radar services.

Radar services are provided within SAL OCENIC FIR / UIR in accordance with procedures specified in ICAO Doc 4444 - chapter 8, supplement by ICAO Regional Procedures contained in Doc 7030. No radar vectoring will be provided below 1700 FT within SAL TMA. Service is restricted to radar monitoring of air traffic below this altitude.

#### 1.6.2. Radar Services

Radar control services provided by Air Traffic Control Units in SAL OCENIC FIR / UIR are as follows:

- 1.6.2.1 Radar separation of departing, arriving and en - route traffic;
- 1.6.2.2 Radar monitoring of air traffic to provide information on any significant deviation from normal flight path;
- 1.6.2.3 Radar vectoring when required;
- 1.6.2.4 Assistance to aircraft in emergency;
- 1.6.2.5 Assistance to aircraft crossing controlled airspace;
- 1.6.2.6 Warnings and position information on other aircraft considered to constitute a hazard;
- 1.6.2.7 Assistance to aircraft experiencing difficulties in navigation or a failure of two - way - communication.

#### 1.6.3. Radar separation

The minimum horizontal radar separation is:

1. 5 NM for the SAL TMA;
2. 10 NM for the remaining area.

#### 1.6.4. Minimum levels

Levels assigned by radar controller to pilots will provide a minimum terrain clearance according to the phase of flight.

#### 1.6.5. Radar coverage

Radar Station location and coverage are:

##### 1.6.5.1 Morro do Curral SSR station:

- Position: 164525 N 0225634 W
- Operational Range: 250 NM (Refreshing Rate 7 SEC)

##### 1.6.5.2 Monte Tchota SSR station:

- Position: 150215 N 0233722 W
- Operational Range: 250 NM (Refreshing Rate 7 SEC)

##### 1.6.5.3 Pedra Rachada SSR station:

- Position: 170653 N 0250348 W
- Operational Range: 250 NM (Refreshing Rate 7 SEC)

**Note:** See radar coverage chart under ENR 1.6.11

#### 1.6.6. SSR ground equipment

The SSR equipment is:

- 1.6.6.1 Capable of interrogating on Mode A and C;
- 1.6.6.2 Capable of decoding up to 4096 codes;
- 1.6.6.3 Not associated with primary radar.

#### 1.6.7. Radar and radio failure procedures

##### 1.6.7.1 Radar failure

In the event of radar failure or loss of radar identification, instructions will be issued to restore non - radar standard operation. Reduced vertical separations of 500 FT or 1000 FT when below or above FL 410, respectively, VMC clearances, and / or holding patterns may be prescribed as emergency measures.

##### 1.6.7.2 Radio communication failures

1.6.7.2.1 SSR equipped aircraft experiencing radio communication failures will operate the transponder on Mode A, Code 7500. SSR may be used for acknowledging of any instructions, to verify the aircraft receiver.

1.6.7.2.2 If the aircraft radio is completely unserviceable, the pilot should carry out the procedures of radio failure in accordance with ICAO provisions. The radar controller will provide separation to identified or non - identified aircraft experiencing complete communications failure, as far as possible, from other airspace users that constitute a hazard, until they have left the airspace concerned or have landed.

##### 1.6.7.2.3 SSR transponder failure

1.6.7.2.3.1 Failure before intended departure - in case of a transponder which has failed and cannot be restored before departure, pilots shall:

- a) inform ATS as soon as possible and preferable before submission of a Flight Plan;
- b) plan to proceed, as directly as possible, to the nearest suitable aerodrome where repair can be effected.
- c) insert in item 10 of the ICAO Flight Plan Form under SSR the letter N of complete unserviceable of the transponder or in case of partial transponder failure, the character corresponding to the remaining transponder capability.

1.6.7.2.3.2 Failure during flight - In case of a transponder failure during flight within or bound to enter Sal controlled airspace, pilots may expect that ATC units will endeavour to provide for continuation of flight to destination in accordance with the Flight Plan. After landing, pilots shall make every effort to have the transponder restored to normal operation. If repair cannot be effected, pilots shall comply with the above provisions for failure before intended departure. The exemption from the requirement for transponder equipment mentioned may be granted by the supervisor on duty in the ACC whenever conditions permit. Change of ETD, cruising level

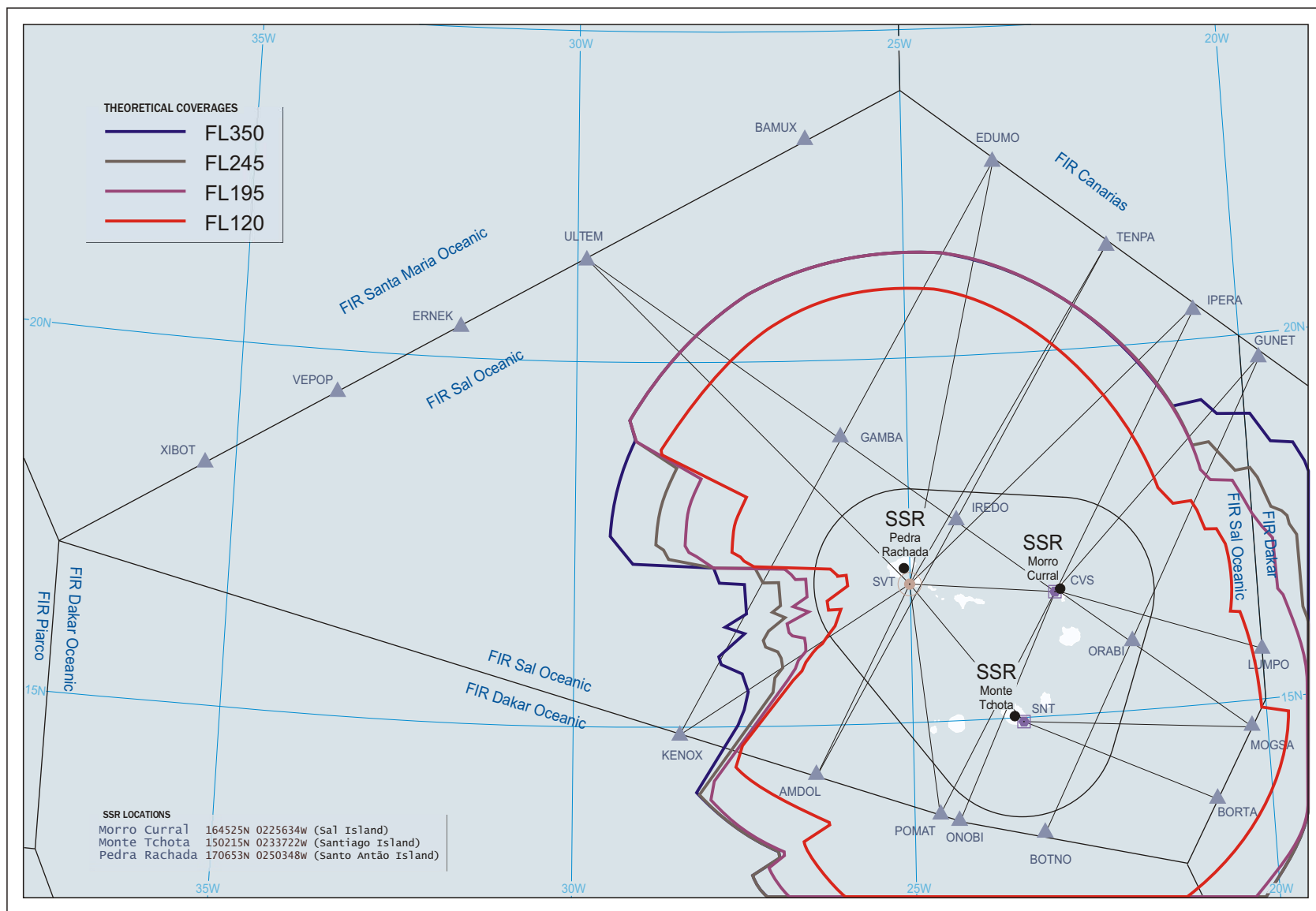

**ENR 1.7 ALTIMETER SETTING PROCEDURES**

**1.7.1. Introduction**

1.7.1.1 The altimeter setting procedures in use generally conform to those contained in ICAO Doc 8168, Vol. I, Part 6 and are given in full below.

1.7.1.2 Transition altitudes are given in AD 2.17 for each aerodrome. In addition, transition altitudes are given on the Instrument Approach charts of all International Aerodromes.

1.7.1.3 QNH reports and temperature information for use in determining adequate terrain clearance are available on request from the air traffic services units. QNH values are given in HPA.

**1.7.2. Basic altimeter setting procedures**

**1.7.2.1 General**

1.7.2.1.1 A transition altitude is specified for each aerodrome. No transition altitude is less than 450 M (1500 FT) above an aerodrome.

1.7.2.1.2 Vertical positioning of aircraft when at or below the transition level is expressed in terms of altitude. Where such positioning at or above the transition level is expressed in terms of altitude when descending and in terms of flight levels when ascending.

1.7.2.1.3 Flight level zero is located at the atmospheric pressure level of 1 013.2 HPA (29.92 IN). Consecutive flight levels are separated by a pressure interval corresponding to 500 FT (152.4 M) in the standard atmosphere.

*Note: Examples of the relationship between flight levels and altimeter indications are given in the following table, the metric equivalents being approximate:*

Flight level number	Altimeter indication	
	Feet	Metres
10	1000	300
15	1500	450
20	2000	600
50	5000	1500
100	10000	3050
150	15000	4550
200	20000	6100

**1.7.2.2 Take - off and climb**

1.7.2.2.1 A QNH altimeter setting is available prior to taxiing for take-off.

1.7.2.2.2 Vertical positioning of aircraft during climb is expressed in terms of altitudes until reaching the transition altitude above which vertical positioning is expressed in terms of flight levels.

1.7.2.2.3 A QFE altimeter setting is available on request.

**1.7.2.3 Vertical separation - en - route**

1.7.2.3.1 Vertical separation of aircraft during en - route flight at and below the transition altitude shall be assessed in terms of altitude.

1.7.2.3.2 Vertical separation of aircraft during en - route flight above the transition altitude shall be assessed in terms of flight

levels.

	000°-179°		180°-359°	
	IFR	VFR	IFR	VFR
Flight level number	10		20	
	30	35	40	45
	50	55	60	65
	70	75	80	85
	90	95	100	105
	...etc.	...etc.	...etc.	...etc.
	270		280	
	290		300	
	310		320	
	330		340	
...etc.		...etc.		
	410		430	
	...etc.		...etc.	

**1.7.2.4 Approach and landing**

1.7.2.4.1 A QNH altimeter setting is made available in approach clearance and in clearance to enter the traffic circuit.

1.7.2.4.2 QFE altimeter settings are available on request.

1.7.2.4.3 Vertical positioning of aircraft during approach is controlled by reference to flight levels until reaching the transition level below which vertical positioning is controlled by reference to altitudes.

1.7.2.4.4 The transition level is made available in approach clearances.

**1.7.2.5 Missed approach**

The relevant portions of 1.7.2.2 and 1.7.2.4 shall be applied in the event of a missed approach.

**1.7.3. Description of altimeter setting region(s)**

The altimeter setting region is Sal. The area covered by this region is shown on the air traffic services chart ENR 2.

**1.7.4. Procedures applicable to operators (including pilots)**

**1.7.4.1 Flight Planning**

The levels at which a flight is to be conducted shall be specified in a flight plan:

1.7.4.1.1 in terms of flight levels if the flight is to be conducted at or above the transition level; and

1.7.4.1.2 in terms of altitudes if the flight is to be conducted in the vicinity of an aerodrome and at or below the transition altitude.

*Note 1: Short flights in the vicinity of an aerodrome may often be conducted only at altitudes below the transition altitude.*

*Note 2: Flight levels are specified in a plan by number and not in terms of feet or metres as is the case with altitudes.*

**1.7.5. Tables of cruising levels**

The cruising levels to be observed when so required are as follows:

TRACK

From 000° to 179°						From 180° to 359°					
IFR Flights			VFR Flights			IFR Flights			VFR Flights		
Altitude			Altitude			Altitude			Altitude		
FL	Metres	Feet	FL	Metres	Feet	FL	Metres	Feet	FL	Metres	Feet
-			-	-	-	0			-	-	-
10	300	1000	-	-	-	20	600	2000	-	-	-
30	900	3000	35	1050	3500	40	1200	4000	45	1350	4500
50	1500	5000	55	1700	5500	60	1850	6000	65	2000	6500
70	2150	7000	75	2300	7500	80	2450	8000	85	2600	8500
90	2750	9000	95	2900	9500	100	3050	10000	105	3200	10500
110	3350	11000	115	3500	11500	120	3650	12000	125	3800	12500
130	3950	13000	135	4100	13500	140	4250	14000	145	4400	14500
150	4550	15000	155	4700	15500	160	4900	16000	165	5050	16500
170	5200	17000	175	5350	17500	180	5500	18000	185	5650	18500
190	5800	19000	195	5950	19500	200	6100	20000			
210	6400	21000				220	6700	22000			
230	7000	23000				240	7300	24000			
250	7600	25000				260	7900	26000			
270	8250	27000				280	8550	28000			
290	8850	29000				300	9150	30000			
310	9450	31000				320	9750	32000			
330	10050	33000				340	10350	34000			
350	10650	33000				360	10950	36000			
370	11300	37000				380	11600	38000			
390	11900	39000				400	12200	40000			
410	12500	41000				430	13100	43000			
450	13700	45000				470	14350	47000			
490	14 950	49000				510	15550	51000			
etc.	etc.	etc.				etc.	etc.	etc.			

**Note:** 1. Some of the lower levels in the above table may not be usable due to terrain clearance requirements.

**Note:** 2. No VFR flight is permitted above FL 195.

**Note:** 3. A flight conducted above FL 200 shall be flown in compliance with IFR.

**Note:** 4. In areas where, on the basis of regional air navigation agreement and in accordance with conditions specified therein, a vertical separation minimum (VSM) of 300 M (1000 FT) is applied between FL 290 and FL 410 inclusive.



## ENR 1.8 REGIONAL SUPPLEMENTARY PROCEDURES (ICAO DOC 7030)

### 1.8.1. Implementation FANS 1 A Services in the SAL OCENIC FIR / UIR airspace

#### 1.8.1.1 Introduction

On 11 / 09 / 22 FANS 1 / A services were implemented over the SAL OCENIC FIR / UIR according with the procedures and limitation described hereafter.

#### 1.8.1.2 FANS 1 / A current limitations

1.8.1.2.1 Only a reduced set of standard CPDLC uplink messages is available (see 1.8.1.6.2). When using CPDLC the following will be observed by controllers:

1. ATC clearances will be only provided using the standard pre - formatted messages;
2. Multiple clearances on a single uplink pre - formatted message (e.g. level change plus direct to) are not possible. The second clearance will be provided after the reception of the WILLCO / UNABLE response to the first clearance;
3. No conditional clearances (e.g. level change including speed restriction) will be provided by ATC;
4. Free text messages will only be used to provide information to pilots. A ROGER response to the free text message is expected.

1.8.1.2.2 Sal FANS 1 / A system is able to accept automatic transfers of FANS 1 / A services coming from its equipped adjacent ACC's. Nevertheless, as the standard CPDLC message UM 160, "Next Data Authority" (NDA) is not available, pilots should not expect automatic transfers of FANS services from SAL ACC to its adjacent ACC's.

#### 1.8.1.3 Safety consideration about FANS 1 / A implementation

1. ADS - C data will never be used for operational purposes such as application of ADS - C separations between aircraft or aircraft and terrain. The application of ADS - C based separations would require extensive evaluations and agreements with adjacent ACC's
2. ADS - C monitoring has to be understood as the use of ADS - C for the purpose of monitoring deviations from the nominal flight path or from the terms of ATC clearances and detecting emergencies and inconsistencies between flight plan data on board and flight plan on ground.
3. Pilot are not released from maintaining and monitoring voice VHF / HF communication.
4. Pilot request and controller instructions via CPDLC are only in the circumstances described on item 1.8.1.6.
5. Requirements and operational procedures adopted are defined for reaching the highest point of compliance with FANS Operations Manual (FOM) version 6.0.

#### 1.8.1.4 Flight planning procedures

1.8.1.4.1 The operator is responsible for correctly inserting items 10 and 18 of the ICAO flight plan according to the FANS procedures.

1.8.1.4.2 The flight plan identification used for logon must be exactly the same as the filed in the ATS flight plan.

1.8.1.5 Procedures for connection (logon) to Sal FANS 1 / A system.

1.8.1.5.1 The aircraft and operators shall be approved either by the State of operator or the State of registration prior to any ADS - C / CPDLC operation.

To avoid an automatic rejection of the logon, pilots shall ensure that the identification and registration number contained in the FN\_CON

message (logon), are exactly the same as the identification and registration numbers filed in the flight plan.

1.8.1.5.2 Traffic entering or overflying SAL OCENIC FIR / UIR coming from CANARIES, DAKAR and SANTA MARIA ACC'S.

1. For aircraft coming from airspace where FANS 1 / A services have been provided, ADS - C and CPDLC will be transferred automatically to SAL ACC (GVSC) by the ACC responsible for the adjacent FIR.
2. If 10 minutes before reaching the common boundary point the automatic log - on with SAL ACC has not been successful, pilots shall start a manual log - on to SAL ACC, sending an AFN Contact message (FN\_CON) containing the 4 character ICAO code of SAL OCENIC FIR / UIR (GVSC).
3. Once the log - on is accepted, the controller shall established the CPDLC connection, which will remain inactive until the CPDLC connection with the transferring ACC is terminated.
4. Immediately after the reception of the log - on, SAL ACC will established the ADS - C connection setting a 15 minutes reporting rate periodic contract and a waypoint change event contract.
5. The transferring ACC will terminate its CPDLC connection 5 minutes prior to the common boundary point.
6. For aircraft coming from airspace where FANS 1 / A services have not been provided, pilots are requested to perform a manual log - on to Sal FANS 1 / A system using the FN\_CON message with the 4 character ICAO code of SAL OCENIC FIR / UIR (GVSC) between 15 and 45 MIN before the common boundary point.
7. Once the log - on is accepted, the controller shall establish the CPDLC and ADS - C connections, requesting a 15 MIN reporting rate periodic contract and a waypoint change event contract.

1.8.1.5.3 Traffic departing from SAL OCENIC FIR / UIR towards CANARIES, DAKAR and SANTA MARIA ACC's.

1. Traffic departing from airports inside SAL OCENIC FIR / UIR inbound to CANARIES, DAKAR and SANTA MARIA ACC's are requested to logon to SAL ACC FANS system before the departure using the FN\_CON message containing the 4 letter ICAO code of SAL OCENIC FIR / UIR (GVSC).
2. Once the log - on is accepted, the controller shall established the CPDLC and the ADS - C connections, requesting a 15 MIN reporting rate periodic contract and a waypoint change event contract.

1.8.1.5.4 Traffic existing from SAL ACC towards CANARIES, DAKAR and SANTA MARIA ACC's

1. Between 15 and 45 MIN before reaching the common boundary point, pilots overflying or departing SAL OCENIC FIR / UIR towards CANARIES, DAKAR and SANTA MARIA ACC's are requested to manually logon (FN\_CON) to GCCC, GOOO or LPPO respectively.
2. SAL ACC will manually terminate the CPDLC connection to Sal FANS 1 / A system 5 MIN before reaching the common boundary point.
3. The flight crew shall ensure that there is no active connection with SAL ACC after crossing the boundary point.

#### 1.8.1.6 CPDLC procedures

1.8.1.6.1 CPDLC is to be used as primary mean of communication in the portion of the SAL OCENIC FIR / UIR airspace between TUTLO and the route UN 741. However, on the route UN 741 pilots connected CPDLC will be advised by controllers as soon as the flight is entering in areas were suitable VHF radio communications can be established with the ATC. The assigned VHF / HF are to be used as a secondary. In the remaining portion of

SAL OCENIC FIR / UIR airspace VHF is to be used as primary mean of communication. CPDLC / HF are to be used as secondary.

1.8.1.6.2 Pilots shall only expect the following set of controller uplink CPDLC pre - formatted messages;

ROGER	-	CLIMB TO (Altitude)
AFFIRM	-	DESCENT TO (Altitude)
NEGATIVE	-	PROCEED DIRECT TO (Position)
STAND BY	-	INCREASE SPEED TO (Speed) OR GREATER
MAINTAIN (Altitude)	-	REDUCE SPEED TO (Speed) OR LESS
RESUME OWN NAVIGATION	-	PROCEED BACK ON ROUTE
CONFIRM ALTI-TUDE	-	OFFSET (Distance offset / direction) OF ROUTE
CONFIRM SPEED	-	REPORT PASSING (Position)
CONFIRM POSI-TION	-	CHECK STUCK MICROPHONE (Frequency)
CONFIRM HEADING	-	REQUEST DEFERRED

1.8.1.6.3 **When using “free Test” uplink messages to provide information to pilots the following will be observed by controllers:**

1. Format and phraseology will be in accordance with the ATC standard;
2. Non - essential words and sentences will be avoided;
3. Abbreviations will only be included if they are in accordance with the standard ATC Phraseology.

1.8.1.6.4 Except in cases of emergency, when controller or pilot communicates via CPDLC, the response shall be via CPDLC.

1.8.1.6.5 If pilots voice response confirms the availability and quality of the voice VHF communications, from that moment, all communications will be performed by voice.

1.8.1.6.6 If pilots or controllers detect situations of poor voice communications, these communications must be performed using CPDLC.

1.8.1.6.7 In cases where CPDLC is used and, in order to avoid a potential ambiguity, pilots should avoid sending downlink multiple clearance request messages.

1.8.1.7 ADS - C procedures

1.8.1.7.1 Aircraft departing from airports inside Sal airspace or entering in SAL OCENIC FIR / UIR coming from its adjacent ACC's must follow the FANS connection / disconnection procedures described in 1.8.1.5.

1.8.1.7.2 In order to minimize the cost of the data communications, the amount of the ADS - C data exchange will kept to the minimum required for operational purposes.

1.8.1.7.3 The following contracts will be always established:

1. A 15 MIN periodic contract requesting;
  1. Basic data
  2. Earth Reference Group
  3. Predicted Route Group
2. Waypoint Change Event contract.

1.8.1.7.4 Apart from the contracts indicated above, additional event or demand contracts, as well as changes on the reporting rate of the periodic contract, can be established or modified in case of operational need.

### 1.8.2. Visual flights rules (VFR) (ICAO Annex 2, 4.8)

VFR flights to be operated within a control zone established at an aerodrome serving international flights and specified portions of the associated terminal control area shall:

1. have a two - way radio communication;
2. obtain permission from the appropriate area traffic control unit; and
3. report positions, as required.

**Note:** The phrase “specified” portions of the associated terminal control area is intended to signify at least those portions of the TMA used by international IFR flights in association with approach, holding, departure and noise abatement procedures.

### 1.8.3. Special application of instrument flight rules

NIL

### 1.8.4. Air traffic advisory service (PANS - RAC, Part VI, 1.4)

NIL

### 1.8.5. Adherence to ATC approved route (ICAO Annex 2, 3.6.2.2)

If an aircraft has inadvertently deviated from the route specified in its ATC clearance, it shall forthwith take action to regain such route within 100 NM from the position at which the deviation was observed.

**ENR 1.9 AIR TRAFFIC FLOW MANAGEMENT (ATFM) AND AIRSPACE MANAGEMENT**

**1.9.1. Air traffic flow management structure service area, service provided, location of unit(s) and hours of operation**

normally "according to local procedures")

1.9.1.1 **Service area**

1.9.2.1.8 Off - load route available (designation, conditions)

NIL

1.9.2.1.9 Remarks

1.9.1.2 **Service provided**

1.9.2.2 Flow control execution cancellation messages

NIL

Flow control execution (date / time group) CNL

1.9.1.3 **Location of unit**

1.9.2.3 Flow control execution change message

NIL

Flow control execution CHG (item(s) to be changed)

1.9.1.4 **Hours of operation**

1.9.2.4 Flow management information message

NIL

Flow management information (text as required)

1.9.1.5 **Remarks**

**1.9.3. Procedures applicable for departing flights**

1.9.1.5.1 SAL ACC, if need be, can provide AFTN service within SAL OCENIC FIR / UIR. Should this happen, the ATS unit is tasked with the provision of:

1.9.3.1 **Service responsible for provision of information on applied ATFM measures**

Information with respect to ATFM measures can be obtained from the ATS Reporting Office (ARO) responsibility for the departure aerodrome.

1.9.1.5.1.1 Issuance of flow management messages.

1.9.3.2 **Flight plan requirements**

1.9.1.5.1.2 Flow regulation.

1.9.3.2.1 Non repetitive ICAO flights plans to or via flow restricted areas shall be submitted to the appropriate ARO at least 3 HRS before ETD.

1.9.1.5.1.3 Time - slot procurement.

1.9.3.2.2 Changes in ETD of more than 20 MIN and / or cancellation of both repetitive and non repetitive flight plans shall be reported immediately to the appropriate ARO.

1.9.1.5.1.4 Co - ordination with adjacent ATFMU's.

**1.9.2. Types of flow messages and descriptions of the formats**

1.9.3.3 **Scheduling Coordinated Airports - Rabil / Aristides Pereira, Praia / Nelson Mandela and Sal Island / Amilcar Cabral**

Messages containing information on ATFM measures, as distributed by SAL ACC unit by AFS, will be formatted as depicted below.

**Note:** These AFS messages can be obtained on request to GVACYFYX

1.9.3.3.1 The Airports Rabil / Aristides Pereira, Praia / Nelson Mandela and Sal Island / Amilcar Cabral were designated fully coordinated airports by the Cabo Verde Civil Aviation Authority, Note / Ref. 132 / ACC - CA / 2017 dated May 08<sup>th</sup>.

All messages will be preceded by:

All aircraft carriers operating to and from these coordinated airports shall always submit a request for the allocation of available landing and / or take - off slots to the coordinator and receive approval before operating.

Priority indicator

Request for slots shall be filled in standard IATA format (Standard Schedules Information Manual, Chapter 6, and Worldwide Scheduling Guidelines) to:

Date / time group, originator indicator.

Monday - Friday (08:00 - 16:00 LT);

1.9.2.1 Flow control execution message.

e-mail: slot.coordination@asa.cv and copied to correspondent handling agent

1.9.2.1.1 Flow control execution MSG NR (sequence number) valid (date).

Out of office hours and weekends, service is provided by Airport Operations fro short term and adhoc schedule changes and request only. Contacts in the table below:

1.9.2.1.2 Due to (reason for restriction).

The Slot Coordination must be copied in all messages.

1.9.2.1.3 Period concerned (time) at.....(slot reference point).

<b>Airport</b>	<b>Telephone</b>	<b>Fax</b>	<b>E - mail</b>
Rabil / Aristides Pereira	+238 2511070	+238 2511193	soica.abv@asa.cv

1.9.2.1.4 Traffic concerned (route, destination, etc.).

1.9.2.1.5 Flight level(s) concerned

1.9.2.1.6 SAL ATFM Unit

1.9.2.1.7 Communication and slot request procedure (indicate

<b>Airport</b>	<b>Telephone</b>	<b>Fax</b>	<b>E - mail</b>
Praia / Nelson Mandela	+238 2633471	+238 2634000	soica.adp@asa.cv
Sal Is- land / Amilcar Cabral	+238 2411309	+238 2411309	soa@asa.cv

All applications should include the following information:

- Aircraft owner / operator
- Aircraft type and registration
- Flight number
- Origin / destination
- Requested time of arrival and departure

1.9.3.3.2 Penalties for non - compliance with slot allocation rules  
Article 11 of decree Law n° 10 / 2016 by stating that the following cases are considered very serious misdemeanors:

- a) Landing and / or take - off of aircraft in fully coordinated airports without previous allocation of a slot;
- b) Failure to cancel an allocated slot by the operator whenever the operator does not intend to use the slot;
- c) Landing and / or take - off of aircraft in violation of the allocated slot in fully coordinated airports, except in cases of force majeure.

Penalties for these offences (considered very serious misdemeanors) are foreseen in decree Law n° 10 / 2016. The amounts, comprised between a minimum of CVE 300000 and a maximum of CVE 5000000 are established in nr. 2 and nr. 3 of article 11 of decree Law 10 / 2016.

Exemptions:

The following reasons and operations exempt flights from slot allocation:

- a) Aircraft to come across urgent situations, taking in account weather, technical failure or flight safety reasons;
- b) Air movements subjected to an unforeseen schedule alteration due to abnormal disturbance within the Air Traffic Control.

## ENR 1.10 FLIGHT PLANNING

### 1.10.1. Procedures for the submission of a flight plan

followed.

#### 1.10.1.1 General

#### 1.10.1.6 Adherence to ATS route structure

1.10.1.1.1 A flight plan shall be submitted in accordance with ICAO Annex 2, paragraph 3.3.1.

No flight plans shall be filed for routes deviating from the published ATS route structure unless prior permission has been obtained from the SAL ATC authorities.

1.10.1.1.2 All operators intending to operate IFR or VFR within SAL OCENIC FIR / UIR shall submit a flight plan (FPL).

#### 1.10.1.7 Authorisation for special flights

#### 1.10.1.2 Time of submission

Flights of a specific character, such as survey flights, scientific research flights, etc., may be exempted from the restriction specified above. A request for exemption shall be mailed so as to be received at least one week before the intended day of operation to:

Except for repetitive flight plans, a flight plan shall be submitted at least 60 minutes prior to departure, taking into account the requirements of ATS units in the airspace along the routes to be flown for timely information, including requirements for early submission for Air Traffic Flow Management (ATFM) purposes.

Civil Aviation Authorities  
TEL: +238 9914282  
e-mail: octavio.oliveira@acivil.gov.cv  
Http: www.SIGA.AAC.CV/EXT/FPR

#### 1.10.1.3 Place of submission

#### 1.10.1.8 Maximum cruising levels for short - range flights

1.10.1.3.1 Flight plans shall be submitted at the Air Traffic Services Reporting Office (ARO) at the departure aerodrome.

NIL

1.10.1.3.2 In the absence of such an office at the departure aerodrome, a flight plan shall be submitted by AFTN, telephone or fax to any of the ARO below:

### 1.10.2. Repetitive flight plan system

Not applicable

AMILCAR CABRAL ARO  
AFS: GVACZPZX  
TEL: +238 2411309  
+238 9925214 (Mobil)  
Telefax:+238 2411309

#### 1.10.2.1 Incidental changes and cancellations of RPL

NIL

NELSON MANDELA ARO  
AFS: GVNPZPZX  
TEL: +238 2633471  
+238 9951700

#### 1.10.2.2 Delay

NIL

ARISTIDES PEREIRA ARO  
AFS: GVBAZPZX  
TEL: +238 2511070  
+238 9817265  
Telefax:+238 2511010

#### 1.10.2.3 ATS messages

NIL

CESARIA EVORA ARO  
AFS: GVSVPZPX  
TEL: +238 2323716  
Telefax:+238 2323716

### 1.10.3. Changes to the submitted flight plan

#### 1.10.1.4 VFR flight plan for alerting service only

#### 1.10.3.1 General changes

An alerting service is, in principle, provided to flights for which a flight plan has been submitted.

All changes to a flight plan submitted for an IFR flight or a controlled VFR flight and significant changes to a flight plan submitted for an uncontrolled VFR flight shall be reported as soon as possible to the appropriate ATS unit. In the event of a delay in departure of 30 MIN or more for a flight for which a flight plan has been submitted, the flight plan shall be amended or a new flight plan shall be submitted after the old plan has been cancelled.

**Note 1:** If a delay in departure of a controlled flight is not properly reported, the relevant flight plan data may no longer be readily available to the appropriate ATS unit when a clearance limit is ultimately requested, which will consequently result in extra delay for the flight.

#### 1.10.1.5 Contents and form of a flight plan

**Note 2:** If a delay in departure (or cancellation) of an uncontrolled VFR flight is not properly reported, alerting or search and rescue action may be unnecessarily initiated when a flight fails to arrive at the destination aerodrome within 30 MIN after its current ETA.

1.10.1.5.1 ICAO flight plan forms are available at the ARO. The instructions for completing these forms shall be followed.

1.10.1.5.2 Flight plans concerning IFR flight along ATS routes need not include FIR boundary estimates. Inclusion of FIR boundary estimates is, however, required for off - route flights and international VFR flights.

1.10.1.5.3 When a flight plan is submitted by AFTN, telephone or telefax, the sequence of items in the flight plan form shall be strictly

Whenever a flight, for which a flight plan has been submitted, is cancelled, the appropriate ATS unit shall be informed immediately.

Changes to a current flight plan for a controlled flight during flight shall be reported or requested, subject to the provisions in ICAO Annex 2, paragraph 3.6.2 (Adherence to flight plan). Significant changes to a flight plan for uncontrolled VFR flight include changes

in endurance or in total number of persons on board and changes in time estimates of 30 MIN or more.

#### 1.10.3.2 Arrival report (closing a flight plan)

A report of arrival shall be made at the earliest possible moment after landing to the airport office of the arrival aerodrome by any flight for which a flight plan has been submitted exempt when the arrival has been acknowledged by the local ATS unit. After landing at the aerodrome which is not the destination aerodrome (diversionary landing), the local ATS unit shall be specifically informed accordingly. In the absence of a local ATS unit at the aerodrome of diversionary landing, the pilot is responsible for passing the arrival report to the destination aerodrome. Arrival reports shall contain the following elements of information:

- Aircraft identification
- Departure aerodrome
- Destination aerodrome
- Time of arrival

In case of diversion, insert the "arrival aerodrome" between "destination aerodrome" and "time of arrival".

#### 1.10.4. Special Flight Plan requirements to operate in RVSM Airspace

The following FPL requirements apply to operators of RVSM approved aircraft intending to conduct flights within SAL OCENIC FIR / UIR RVSM airspace:

1.10.4.1 Operators of RVSM approved aircraft shall indicate the approval status by inserting the letter W in the item 10 of the ICAO Flight Plan Form, regardless of the requested flight level.

1.10.4.2 Operators of RVSM approved aircraft intending to operate within the SAL OCENIC FIR / UIR RVSM airspace shall include the following in item 15 of the ICAO Flight Plan Form:

1.10.4.2.1 The entry point at the lateral limits of the SAL OCENIC FIR / UIR RVSM airspace and the requested flight level for that portion of the route commencing immediately after the RVSM entry point; and

1.10.4.2.2 The exit point at the lateral limits of the SAL OCENIC FIR / UIR RVSM airspace and the requested flight level for that portion of the route commencing immediately after the RVSM exit

point.

Asa-EMPRESA NACIONAL DE SEGURANÇA AEREA-S.A  
REPÚBLICA DE CABO VERDE

FLIGHT PLAN-PLANO DE VOO

<p><b>PRECEDENCE</b> Prioridade</p> <p>←≡FF→</p>	<p><b>ADDRESSES TO</b> Os destinatários</p> <p>_____</p> <p>_____</p> <p>_____</p>
<p><b>FLIGHT TIME</b> Hora de Despêso</p> <p>_____</p>	<p><b>ORIGINATOR</b> Origem</p> <p>_____</p>
<p><small>SPECIFIC IDENTIFICATION OF ADDRESSES (S) AND/OR ORIGINATOR</small> Identificação específica dos(s) destinatário(s) e/ou origem</p>	
<p><b>MESSAGE TYPE</b> Tipo de mensagem</p> <p>←≡(FPL</p>	<p><b>7 AIRCRAFT IDENTIFICATION</b> Identificação da Aeronave</p> <p>_____</p>
<p><b>9 NUMBER</b> Número</p> <p>_____</p>	<p><b>TYPE OF AIRCRAFT</b> Tipo de Aeronave</p> <p>_____</p>
<p><b>13 DEPARTURE AERODROME</b> Aeródromo de Partida</p> <p>_____</p>	<p><b>TIME</b> Hora</p> <p>_____</p>
<p><b>15 CRUISING SPEED</b> Velocidade de Cruzeiro</p> <p>_____</p>	<p><b>LEVEL</b> Nível</p> <p>_____</p>
<p><b>16 DESTINATION AERODROME</b> Aeródromo de Destino</p> <p>_____</p>	<p><b>TOTAL EET</b> Duração total Prevista</p> <p>_____</p>
<p><b>19 OTHER INFORMATION</b> Outras Informações</p> <p>_____</p>	<p><b>8 FLIGHT RULES</b> Regras de Voo</p> <p><input type="checkbox"/></p>
<p><b>10 EQUIPMENT</b> Equipamento</p> <p>_____ / _____</p>	<p><b>TYPE OF FLIGHT</b> Tipo de Voo</p> <p><input type="checkbox"/></p>
<p><b>11 WAKE TURBULANCE CAT</b> Categoria do Rasto Aerodinâmico</p> <p><input type="checkbox"/></p>	<p><b>12 ALTN AERODROME</b> Aeródromo Alternativo</p> <p>_____</p>
<p><b>14 ALTN AERODROME</b> 2º Aeródromo Alternativo</p> <p>_____</p>	<p><b>EMERGENCY RADIO</b> Equipamento de Emergência</p> <p>WF <input type="checkbox"/> ELBA <input type="checkbox"/></p>
<p><b>SUPPLEMENTARY INFORMATION (NOT TO BE TRANSMITTED IN FPL MSGS)</b> Informações suplementares (Não transmitidas nas mensagens do FPL)</p>	
<p><b>15 ENDURANCE</b> Autonomia</p> <p>E / _____</p>	<p><b>PERSONS ON BOARD</b> Pessoas a bordo</p> <p>P / _____</p>
<p><b>SURVIVAL EQUIPMENT</b> / Equipamento de Sobrevivência</p> <p>→ S / P</p>	<p><b>JACKETS/Coletes de Salvação</b></p> <p>J → J / L</p>
<p><b>DINGHIES</b> / Balcões</p> <p>→ D / _____</p>	<p><b>FLUORES</b></p> <p>UF <input type="checkbox"/> VF <input type="checkbox"/></p>
<p><b>NUMBER</b></p> <p>→ _____</p>	<p><b>CAPACITY</b></p> <p>→ _____</p>
<p><b>COVER</b></p> <p>→ C → _____</p>	<p><b>COLOR</b></p> <p>→ _____</p>
<p><b>AIRCRAFT COLOUR AND MARKINGS</b> / Cor e Marca da Aeronave</p> <p>— A / _____</p>	
<p><b>REMARKS</b>/Observações</p> <p>→ N / _____</p>	
<p><b>PILOT-IN-COMMAND</b> / Piloto Comandante</p> <p>— C / _____</p>	
<p><b>FILED BY</b> / Preenchido Por</p> <p>_____</p>	<p><b>SIGNATURE OF ATIS-OFFICER</b>/Assinatura do Oficial-ATIS</p> <p>_____</p>
<p><b>AF IN TRANSMISSION</b> / Transmissão APTN</p> <p>_____</p>	<p><b>TIME</b> Hora</p> <p>_____</p>



**ENR 1.11 ADDRESSING OF FLIGHT PLAN MESSAGES**

Flight movement messages relating to traffic into or via SAL OCENIC FIR shall be addressed as stated below in order to warrant correct relay and delivery.

**Note:** Flight movement message in this context comprise flight plan messages, amendment messages relating thereto and flight plan cancellation messages (ICAO PANS-ATM, Doc 4444, Chapter 11, paragraph 11.1.3 (a) refers).

Category of flight (IFR, VFR or both) 1	Route (into or via FIR / UIR and / or TMA) 2	Message address 3
All Flights (IFR / VFR)	into or via SAL OCENIC FIR / UIR	GVSCZQZX GVACYSYX GVACFDPX
All Flights (IFR / VFR)	Outbound from any of the INTL airports located within the SAL TMA	GVACZPZX GVNPZPZX GVBAZPZX GVSZPZX Depending on the aerodrome of departure

**INTENTIONALLY LEFT BLANK**

**ENR 1.12 INTERCEPTION OF CIVIL AIRCRAFT**

**1.12.1. Interception procedures**

1.12.1.1 The following procedures and visual signals apply over the territory and territorial waters of the Republic of Cabo Verde in the event of interception of an aircraft.

\* The word "interception" in this context does not include intercept and escort service provided, on request, to an aircraft in distress, in accordance with the International Aeronautical and Maritime Search and Rescue Manual (IAMSAR) Doc 9731.

1.12.1.1.1 An aircraft which is intercepted by another aircraft shall immediately:

1. Follow the instructions given by the intercepting aircraft, interpreting and responding to visual signals in accordance with specifications.
2. Notify, if possible, the appropriate air traffic services unit.
3. Attempt to establish radio communication with the intercepting aircraft or with the appropriate intercept unit control by making a general call on the emergency frequency 121.500 MHz, giving the identity of the intercepted aircraft and the nature of the flight, and if no contact has been established and if practicable, repeating this call on emergency 243.000 MHz.

1.12.1.1.2 If any instructions received by radio from any sources conflict with those given by the intercepting aircraft by radio, the intercepted aircraft shall request immediate clarification while continuing to comply with the radio instructions given by the intercepting aircraft.

1.12.1.1.3 If any instructions received by radio from any sources conflict with those given by the intercepting aircraft by visual signals, the intercepted aircraft shall request immediate clarification while continuing to comply with the radio instructions given by the intercepting aircraft.

**1.12.2. Radio communication during interception**

1.12.2.1 If radio contact is established during interception but communication in a common language is not possible, attempts shall be made to convey essential information by using the phrases and pronunciations contained in the following tables hereunder and transmitting each phrase twice:

1.12.2.1.1 Phrases for use by intercepting aircraft

<i>Phrase</i>	<i>Pronunciation (1)</i>	<i>Meaning</i>
CALL SIGN	<b>KOL</b> SA-IN	What is your call sign?
FOLLOW	<b>FO</b> -LO	Follow me
DESCEND	DEE-SEND	Descend for landing
YOU LAND	<b>YOU LAAND</b>	Land at this aerodrome
PROCEED	PRO-SEED	You may proceed

(1) Syllables to be emphasised are in bold type.

1.12.2.1.2 Phrases for use by intercepted aircraft:

<i>Phrase</i>	<i>Pronunciation (1)</i>	<i>Meaning</i>
CALL SIGN (call sign) (2)	<b>KOL</b> - SA - IN (call sign)	My call sign is (call sign)
WILLCO	<b>VILL</b> - KO	Understood. Will comply
CAN NOT	<b>KANN</b> NOT	Unable to comply
REPEAT	REE - PEET	Repeat your instruction
AM LOST	<b>AM LOST</b>	Position unknown
MAYDAY	<b>MAYDAY</b>	I am in distress
HIJACK (3)	<b>HI</b> - JACK	I have been hijacked
LAND (place name)	LAAND (place name)	I request to land at (place name)
DESCEND	DEE <b>SEND</b>	I require descent

(1) Syllables to be emphasised are in bold type.

(2) The call sign required to be given is that used in radio telephony communication with air traffic services units and corresponding to the aircraft identification in the flight plan.

(3) Circumstances may not always permit, nor make desirable, the use of the phrase "HIJACK".

**Table 1.12. -1: Visual Interception Signals**

Series	INTERCEPTING Aircraft Signals	Meaning	INTERCEPTED Aircraft Responds	Meaning
1	<p><b>DAY or NIGHT</b> - Rocking aircraft and flashing navigational lights at irregular intervals (and landing lights in the case of a helicopter) from a position slightly above and ahead of, and normally to the left of, the intercepted aircraft (or to the right if the intercepted aircraft is a helicopter) and, after acknowledgement, a slow level turn, normally to the left, (or to the right in the case of a helicopter) on the desired heading.</p> <p><b>Note 1:</b> Meteorological conditions or terrain may require the intercepting aircraft to reverse the positions and directions of turn given above in Series 1.</p> <p><b>Note 2:</b> If the intercepted aircraft is not able to keep pace with the intercepting aircraft, the latter is expected to fly a series of racetrack patterns and to rock the aircraft each time it passes the intercepted aircraft.</p>	You have been intercepted. Follow me.	<b>DAY or NIGHT</b> - Rocking aircraft, flashing navigational lights at irregular intervals and following.	Understood, will comply.
2	<b>DAY or NIGHT</b> - An abrupt breakaway manoeuvre from the intercepted aircraft consisting of a climbing turn of 90 degrees or more without crossing the line of flight of the intercepted aircraft.	You may proceed.	<b>DAY or NIGHT</b> - Rocking aircraft.	Understood, will comply.
3	<b>DAY or NIGHT</b> - Lowering landing gear (if fitted), showing steady landing lights and overflying runway in use or, if the intercepted aircraft is a helicopter, overflying the helicopter landing area. In the case of helicopters, the intercepting helicopter makes a landing approach, coming to hover near to the landing area.	Land at this aerodrome.	<b>DAY or NIGHT</b> - Lowering landing gear, (if fitted), showing steady landing lights and following the interception aircraft and, if, after overflying the runway in use or helicopter landing area, landing is considered safe, proceeding to land.	Understood, will comply.

**Signals initiated by intercepted aircraft and responses by interceptor**

Series	INTERCEPTED Aircraft Signals	Meaning	INTERCEPTING Aircraft Responds	Meaning
4	<b>DAY or NIGHT</b> - Raising landing gear (if fitted) and flashing landing lights while passing over runway in use or helicopter landing area at height exceeding 300 M (1000 FT) but not exceeding 600 M (2000 FT) (in the case of a helicopter, at a height exceeding 50 M (170 FT) but not exceeding 100 M (330 FT) above the aerodrome level, and continuing to circle runway in use or helicopter landing area. If unable to flash landing lights, flash any other lights available.	Aerodrome you have designated is inadequate.	<b>DAY or NIGHT</b> - If it is desired that the intercepted aircraft follow the intercepting aircraft to an alternate aerodrome, the intercepting aircraft raises its landing gear (if fitted) and uses the Series 1 signals prescribed for intercepting aircraft.	Understood, follow me.
5	<b>DAY or NIGHT</b> - Regular switching on and off of all available lights but in such a manner as to be distinct from flashing lights.	Cannot comply.	<b>DAY or NIGHT</b> - Use Series 2 signals prescribed for intercepting aircraft	Understood.
6	<b>DAY or NIGHT</b> - Irregular flashing of all available lights.	In distress.	<b>DAY or NIGHT</b> - Use Series 2 signals prescribed for intercepting aircraft.	Understood.

**1.12.3. Distress Signals**

The following signals, used either together or separately, means that grave and imminent danger threatens, and immediate assistance is requested:

1. A signal made by radio telegraphy or by any other signalling method consisting of the group SOS (... \_ \_ \_... in the Morse Code)
2. A signal sent by radio telephony consisting of the spoken word MAYDAY.

3. Rockets or shells throwing red lights, fired one at a time at short intervals.
4. A parachute flare showing a red light.

## ENR 1.13 UNLAWFUL INTERFERENCE

### 1.13.1. General

The following procedures are intended for use by aircraft when unlawful interference occurs and the aircraft is unable to notify an ATS unit of this fact.

### 1.13.2. Procedures

1.13.2.1 Unless considerations aboard the aircraft dictate otherwise, the pilot - in - command should attempt to continue flying on the assigned track and at the assigned cruising level at least until notification to an ATS unit is possible.

1.13.2.2 When an aircraft subjected to an act of unlawful interference and must depart from its assigned track or its assigned cruising level without being able to make radio telephony contact with ATS, the pilot - in - command should, whenever possible:

1.13.2.2.1 Attempt to broadcast warnings on the VHF emergency frequency and other appropriate frequencies, unless considerations aboard the aircraft dictate otherwise. Other equipment such as on-board transponders, data links, etc. should be used when it is advantageous to do so and circumstances permit; and

1.13.2.2.2 Proceed in accordance with applicable special procedures for in - flight contingencies, where such procedures have been established and promulgated in ICAO Doc 7030 - *Regional Supplementary Procedures*; or

1.13.2.2.3 If no applicable regional procedures have been established, proceed at a level which differs from the cruising levels normally used for IFR flight in the area by 300 M (1000 FT) if above FL 290 or by 150 M (500 FT) if below FL 290.

**INTENTIONALLY LEFT BLANK**

## ENR 1.14 AIR TRAFFIC INCIDENTS

### 1.14.1. Definition of air traffic incidents

1.14.1.1 "Air traffic incident" is used to mean a serious occurrence related to the provision of air traffic services, such as:

1.14.1.1.1 Aircraft proximity (AIRPROX);

1.14.1.1.2 Serious difficulty resulting in a hazard to aircraft caused, for example, by:

1.14.1.1.2.1 Faulty procedures

1.14.1.1.2.2 Non-compliance with procedures, or

1.14.1.1.2.3 Failure of ground facilities.

1.14.1.2 Definitions for aircraft proximity and AIRPROX.

1.14.1.2.1 **Aircraft proximity is a situation** in which, in the opinion of the pilot or the air traffic services personnel, the distance between aircraft, as well as their relative positions and speed, has been such that the safety of the aircraft involved may have been compromised. Aircraft proximity is classified as follows:

1.14.1.2.1.1 **Risk of collision.** The risk classification of aircraft proximity in which serious risk of collision has existed.

1.14.1.2.1.2 **Safety not assured.** The risk classification of aircraft proximity in which the safety of the aircraft may have been compromised.

1.14.1.2.1.3 **No risk of collision.** The risk classification of aircraft proximity in which no risk of collision has existed.

1.14.1.2.1.4 **Risk not determined.** The risk classification of aircraft proximity in which insufficient information was available to determine the risk involved, or inconclusive or conflicting evidence precluded such determination.

1.14.1.2.1.5 **AIRPROX.** The code word used in an air traffic incident report to designate aircraft proximity.

1.14.1.3 Air traffic incidents are designated and identified in reports as follows:

Type	Designation
Air traffic incident	Incident
as a) above	AIRPROX (aircraft proximity)
as b) 1) and 2) above	Procedure
as b) 3) above	Facility

### 1.14.2. Use of the Air Traffic Incident Report Form (See model on pages ENR 1.14-2 to 1.14-6)

1.14.2.1 The Air Traffic Incident Report Form is intended for use:

1.14.2.1.1 By a pilot for filing a report on an air traffic incident after arrival or for confirming a report made initially by radio during flight.

**Note:** The form, if available on board, may also be of use in providing a pattern for making the initial report in flight.

1.14.2.1.2 By an ATS unit for recording an air traffic incident report received by radio, telephone or teleprinter.

**Note:** The form may be used as the format for the text of a message to be transmitted over the AFS network.

### 1.14.3. Reporting procedures (including in-flight procedures)

1.14.3.1 The following are the procedures to be followed by a pilot who is or has been involved in an incident:

1.14.3.1.1 During flight, use the appropriate air / ground frequency for reporting an incident of major significance, particularly if it involves other aircraft, so as to permit the facts to be ascertained immediately;

1.14.3.1.2 As promptly as possible after landing, submit a completed Air Traffic Incident Report Form

1.14.3.1.3 For confirming a report of an incident made initially as in 3.1.1 above, or for making the initial report on such an incident if it had not been possible to report it by radio;

1.14.3.1.4 For reporting an incident which did not require immediate notification at the time of occurrence.

1.14.3.2 An initial report made by radio should contain the following information:

1.14.3.2.1 Aircraft identification;

1.14.3.2.2 Type of incident, e.g. aircraft proximity;

1.14.3.2.3 The incident; 1. a) and b); 2. a), b), c), d), n); 3. a), b), c), i); 4. a), b);

1.14.3.2.4 Miscellaneous: 1. e).

1.14.3.3 The confirmatory report on an incident of major significance reported by radio or the initial report on any other incident should be submitted to Civil Aviation Administration, or to the ATS Reporting Office located at Sal Island / Amílcar Cabral aerodrome. The pilot should complete an air traffic form supplementing the details of the initial reports as necessary.

**Note:** Where there is no ATS Reporting Office, the report may be submitted to another ATS unit.

### 1.14.4. Purpose of reporting and handling of the form

1.14.4.1 The purpose of the reporting of aircraft proximity incidents and their investigation is to promote the safety of aircraft. The degree of risk involved in an aircraft proximity incident should be determined in the incident investigation and classified as "risk of collision", "safety not assured", "no risk of collision" or "risk not determined".

1.14.4.2 The purpose of the form is to provide investigation authorities with as complete information on an air traffic incident as possible to enable them to report back, with the least possible delay to the pilot or operator concerned, the result of the investigation of the incident and, if appropriate, the remedial action taken.

**AIR TRAFFIC INCIDENT REPORT FORM**

*For use when submitting and receiving reports on air traffic incidents. In an initial report by radio, shaded items should be included.*

<b>A — AIRCRAFT IDENTIFICATION</b>	<b>B — TYPE OF INCIDENT</b>
	AIRPROX / PROCEDURE / FACILITY*

**C — THE INCIDENT**

**1. General**

- a) Date / time of incident UTC
- b) Position

**2. Own aircraft**

- a) Heading and route
- b) True airspeed \_\_\_\_\_ measured in ( ) kt \_\_\_\_\_ ( ) km/h \_\_\_\_\_
- c) Level and altimeter setting
- d) Aircraft climbing or descending  

( ) Level flight	( ) Climbing	( ) Descending
------------------	--------------	----------------
- e) Aircraft bank angle  

( ) Wings level	( ) Slight bank	( ) Moderate bank
( ) Steep bank	( ) Inverted	( ) Unknown
- f) Aircraft direction of bank  

( ) Left	( ) Right	( ) Unknown
----------	-----------	-------------
- g) Restrictions to visibility (select as many as required)  

( ) Sunglare	( ) Windscreen pillar	( ) Dirty windscreen
( ) Other cockpit structure	( ) None	
- h) Use of aircraft lighting (select as many as required)  

( ) Navigation lights	( ) Strobe lights	( ) Cabin lights
( ) Red anti-collision lights	( ) Landing / taxi lights	( ) Logo (tail fin) lights
( ) Other	( ) None	
- i) Traffic avoidance advice issued by ATS  

( ) Yes, based on radar	( ) Yes, based on visual sighting	( ) Yes, based on other information
( ) No		
- j) Traffic information issued  

( ) Yes, based on radar	( ) Yes, based on visual sighting	( ) Yes, based on other information
( ) No		
- k) Airborne collision avoidance system — ACAS  

( ) Not carried	( ) Type	( ) Traffic advisory issued
( ) Resolution advisory issued	( ) Traffic advisory or resolution advisory not issued	
- l) Radar identification  

( ) No radar available	( ) Radar identification	( ) No radar identification
------------------------	--------------------------	-----------------------------
- m) Other aircraft sighted  

( ) Yes	( ) No	( ) Wrong aircraft sighted
---------	--------	----------------------------

\*Delete as appropriate



n)	Avoiding action taken		
	<input type="checkbox"/> Yes	<input type="checkbox"/> No	
o)	Type of flight plan		
	IFR / VFR / none*		
<b>3. Other aircraft</b>			
a)	Type and call sign / registration (if known)		
b)	If a) above not known, describe below		
	<input type="checkbox"/> High wing	<input type="checkbox"/> Mid wing	<input type="checkbox"/> Low wing
	<input type="checkbox"/> Rotorcraft		
	<input type="checkbox"/> 1 engine	<input type="checkbox"/> 2 engines	<input type="checkbox"/> 3 engines
	<input type="checkbox"/> 4 engines	<input type="checkbox"/> More than 4 engines	
	Marking, colour or other available details		
c)	Aircraft climbing or descending		
	<input type="checkbox"/> Level flight	<input type="checkbox"/> Climbing	<input type="checkbox"/> Descending
	<input type="checkbox"/> Unknown		
d)	Aircraft bank angle		
	<input type="checkbox"/> Wings level	<input type="checkbox"/> Slight bank	<input type="checkbox"/> Moderate bank
	<input type="checkbox"/> Steep bank	<input type="checkbox"/> Inverted	<input type="checkbox"/> Unknown
e)	Aircraft direction of bank		
	<input type="checkbox"/> Left	<input type="checkbox"/> Right	<input type="checkbox"/> Unknown
f)	Lights displayed		
	<input type="checkbox"/> Navigation lights	<input type="checkbox"/> Strobe lights	<input type="checkbox"/> Cabin lights
	<input type="checkbox"/> Red anti-collision lights	<input type="checkbox"/> Landing / taxi lights	<input type="checkbox"/> Logo (tail fin) lights
	<input type="checkbox"/> Other	<input type="checkbox"/> None	<input type="checkbox"/> Unknown
g)	Traffic avoidance advice issued by ATS		
	<input type="checkbox"/> Yes, based on radar	<input type="checkbox"/> Yes, based on visual sighting	<input type="checkbox"/> Yes, based on other information
	<input type="checkbox"/> No	<input type="checkbox"/> Unknown	
h)	Traffic information issued		
	<input type="checkbox"/> Yes, based on radar	<input type="checkbox"/> Yes, based on visual sighting	<input type="checkbox"/> Yes, based on other information
	<input type="checkbox"/> No	<input type="checkbox"/> Unknown	
i)	Avoiding action taken		
	<input type="checkbox"/> Yes	<input type="checkbox"/> No	<input type="checkbox"/> Unknown

\*Delete as appropriate

<b>4. Distance</b> a) Closest horizontal distance b) Closest vertical distance
<b>5. Flight weather conditions</b> a) IMC / VMC* b) Above / below* clouds / fog / haze or between layers* c) Distance vertically from cloud _____ m / ft* below _____ m / ft* above d) In cloud / rain / snow / sleet / fog / haze* e) Flying into / out of* sun f) Flight visibility _____ m / km*
<b>6. Any other information considered important by the pilot-in-command</b>
<b>D — MISCELLANEOUS</b>
<b>1. Information regarding reporting aircraft</b> a) Aircraft registration b) Aircraft type c) Operator d) Aerodrome of departure e) Aerodrome of first landing _____ destination f) Reported by radio or other means to _____ (name of ATS unit) at time UTC g) Date / time / place of completion of form
<b>2. Function, address and signature of person submitting report</b> a) Function b) Address c) Signature d) Telephone number
<b>3. Function and signature of person receiving report</b> a) Function _____ b) Signature _____

\*Delete as appropriate

**E — SUPPLEMENTARY INFORMATION BY ATS UNIT CONCERNED**

**1. Receipt of report**

- a) Report received via AFTN / radio / telephone / other (specify)\* \_\_\_\_\_
- b) Report received by \_\_\_\_\_ (name of ATS unit)

**2. Details of ATS action**

Clearance, incident seen (radar/visually, warning given, result of local enquiry, etc.)

---



---



---



---



---



---

**DIAGRAMS OF AIRPROX**

Mark passage of other aircraft relative to you, in plan on the left and in elevation on the right, assuming YOU are at the centre of each diagram. Include first sighting and passing distance.

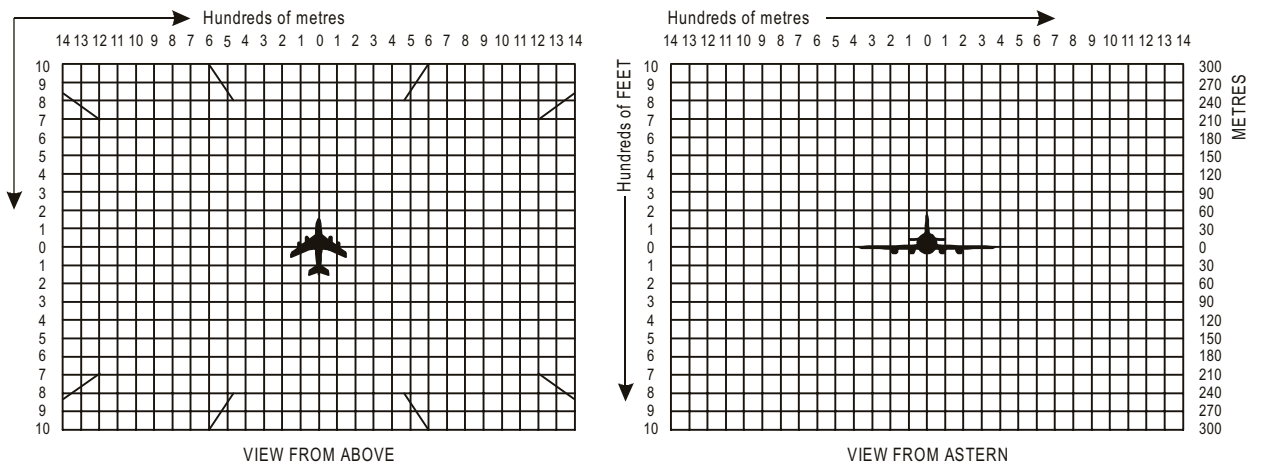

\*Delete as appropriate

<b>Instructions for the completion of the Air Traffic Incident Report Form</b>	
<i>Item</i>	
A	Aircraft identification of the aircraft filing the report.
B	An AIRPROX report should be filed immediately by radio.
C1	Date / time in UTC and position in bearing and distance from a navigation aid or in LAT / LONG.
C2	Information regarding aircraft filing the report, tick as necessary.
C2 c)	E.g. FL 350 / 1013 HPA or 2500 FT / QNH 1007 HPA or 1200 FT / QFE 998 HPA.
C3	Information regarding the other aircraft involved.
C4	Passing distance - state units used.
C6	Attach additional papers as required. The diagrams may be used to show aircraft's positions.
D1 f)	State name of ATS unit and date / time in UTC.
D1 g)	Date and time in UTC.
E2	Include details of ATS unit such as service provided, radio - telephony frequency, SSR Codes assigned and altimeter setting. Use diagram to show the aircraft's position and attach additional papers as required.

ENR 2. AIR TRAFFIC SERVICES AIRSPACE

ENR 2.1 FIR, UIR, TMA AND CTA

Name Lateral limits Vertical limits Class of airspace	Unit providing service	Call sign Languages Area and conditions of use Hours of service	Frequency/ Purpose	Remarks
1	2	3	4	5
<p><b>SAL OCENIC FIR / SAL OCEANIC UIR</b></p> <p>240000N 0250000W - 200000N 0200000W - 150000N 0200000W - 125800N 0212200W - 134000N 0242100W - 170000N 0373000W</p> <p>FIR</p> <p style="text-align: center;"><u>GND / MSL</u> FL 245</p> <p>UIR</p> <p style="text-align: center;"><u>UNL</u> FL 245</p> <p>Class of airspace: G below FL 245 Class of airspace: A above FL 245</p>	<p>SAL ACC / AMILCAR CABRAL FIC</p>	<p>SAL CONTROL English Portuguese</p> <p>H 24</p>	<p>128.300 MHZ 127.100 MHZ 126.400 MHZ 121.500 MHZ</p>	<p>North Sector South Sector TMA Sector Emergency</p>
<p><b>SAL UTA</b></p> <p>240000N 0250000W - 200000N 0200000W - 150000N 0200000W - 125800N 0212200W - 134000N 0242100W - 170000N 0373000W</p> <p style="text-align: center;"><u>UNL</u> FL 245</p> <p>Class of airspace: A</p>	<p>SAL ACC</p>	<p>SAL CONTROL English Portuguese</p> <p>H 24</p>	<p>128.300 MHZ 127.100 MHZ 126.400 MHZ 121.500 MHZ</p>	<p>North Sector South Sector TMA Sector Emergency RVSM airspace from FL 290 to FL 410 inclusive</p>
<p><b>AIRWAYS WITHIN SAL OCEANIC FIR</b></p> <p style="text-align: center;"><u>FL 245</u></p> <p>Lower Limit of airway Class of airspace: A - FL 195 - FL 245 Class of airspace: C - below FL 195</p>	<p>SAL ACC</p>	<p>SAL CONTROL English Portuguese</p> <p>H 24</p>	<p>128.300 MHZ 127.100 MHZ 121.500 MHZ</p>	<p>Emergency See ENR 3.1 for lower limit of AWYs Excluding SAL TMA</p>
<p><b>SAL TMA</b></p> <p>Area delimited by three arcs of circle of 80 NM radius centred on VOR / DME CVS (164412.02N 0225703.06W), VOR / DME SNT (145620.74N 0232855.64W) and NDB SVT (164944.9N 0250352.6W) and the external tangents joining these arcs.</p> <p style="text-align: center;"><u>FL 245</u> 700 FT</p> <p>Class of airspace: A above FL 195 Class of airspace: C below FL 195</p>	<p>SAL ACC</p>	<p>SAL CONTROL English Portuguese</p> <p>H 24</p>	<p>126.400 MHZ 121.500 MHZ</p>	<p>TMA Sector Emergency Excluding SAL CTR Excluding PRAIA CTR Excluding SAO VICENTE CTR</p>

### 2.1.1. Strategic Lateral Offsets in Oceanic Airspace to mitigate Collision Risk and Wake Turbulence

This procedure is in force throughout the SAL OCENIC FIR / UIR and is based on the following guidelines:

2.1.1.1 Strategic lateral offsets shall be applied only by aircraft with automatic offset tracking capability.

2.1.1.2 Strategic lateral offset and those executed to mitigate the effects of wake turbulence are to be made to the right of a route or track.

2.1.1.3 In relation to a route or track, there are three positions that an aircraft may fly, namely **centreline**, **1 or 2 NM** right and offsets are not to exceed 2 NM right of the centreline.

2.1.1.4 There is no ATC clearance required for this procedure and it is not necessary that ATC be advised.

### 2.1.2. Special Procedures for In - Flight Contingencies within Sal Oceanic airspace

#### 2.1.2.1 Introduction

2.1.2.1.1 Although all possible contingencies cannot be covered, the procedures in 2.1.2.2 and 2.1.2.3 provide for more frequent cases such as:

- a) inability to maintain assigned flight level due to meteorological conditions, aircraft performance or pressurisation failure;
- b) en - route diversion across the prevailing traffic flow; and
- c) loss of, or significant reduction in, the required navigation capability when operating in an airspace where the navigation performance accuracy is prerequisite to the safe conduct of flight operations.

2.1.2.1.2 With regards to 2.1.2.1.1 a) and b), the procedures are applicable primarily when rapid descend and / or turn back or diversion is required. the pilot's judgement shall determine the sequence of actions to be taken, having regard to the prevailing circumstances. Air traffic control shall render all possible assistance.

#### 2.1.2.2 General Procedures

2.1.2.2.1 If an aircraft is unable to continue the flight in accordance with its ATC clearance, and / or an aircraft is unable to maintain the navigation performance accuracy specified for the airspace, a revised clearance shall be obtained, whenever possible, prior to initiating any action.

2.1.2.2.2 The radio telephony distress signal (MAYDAY) or urgency signal (PAN PAN) preferably spoken three times shall be used as appropriate subsequent ATC action with respect to that aircraft shall be based on the intentions of the pilot and the overall traffic situation.

2.1.2.2.3 If prior clearance cannot be obtained, and ATC clearance shall be obtained at the earliest possible time and, until revised clearance is received, the pilot shall:

- a) leave the assigned route or track by initially turning 90 degrees to the right or to the left. When possible, the direction of the turn should be determined by the position of the aircraft relative to any organized route or track system. Other factors which any affect the direction of the turn are:

- i. the direction to an alternate airport, terrain clearance;
- ii. any lateral offset being flown; and
- iii. the flight levels allocated on adjacent routes or tracks;

- b) following the turn, the pilot should:

- i. if unable to maintain the assigned flight level, initially minimize the rate of descend to the extent that is operationally feasible;
- ii. take account of other aircraft being laterally offset from its track;
- iii. acquire and maintain in either direction a track laterally separated by 28 KM (15 NM) from the assigned route; and
- iv. once established on the offset track, climb or descend to select a flight level which differs from those normally used by 150 M (500 FT);

- c) establish communication with and alert nearby aircraft by broadcasting, at suitable intervals aircraft identification, flight level, position (including the ATS route designator or track code, as appropriate) and intentions on the frequency in use and on 121.500 MHZ (or, as a back - up, on the inter - pilot air - to - air frequency 123.450 MHZ);
- d) maintain a watch for conflicting traffic both visually and by reference to ACAS (if equipped);
- e) turn on all aircraft exterior lights (communicate with appropriate operating limitations);
- f) keep the SSR transponder on at all times; and
- g) take action as necessary to ensure the safety of the aircraft.

**Note:** when leaving the assigned track to acquire and maintain the track laterally separated by 28 KM (15 NM), the flight crew should, where practicable, avoid bank angles that would result in overshooting the track to be acquired, particularly in airspace where a 55.5 KM (30 NM) lateral separation minimum is applied.

2.1.2.2.4 Extended Range Operations by aeroplanes with two - turbine power - units (ETOPS). If the contingency procedure are employed by a twin - engine aircraft as a result of an engine shut down or failure of an ETOPS critical system, the pilot should advise ATC as soon as practicable of the situation, reminding ATC of the type of aircraft involved, and request expeditious handling.

#### 2.1.2.3 Weather Deviation Procedures

##### 2.1.2.3.1 General

**Note:** The following procedures are intended for deviations around adverse meteorological conditions.

2.1.2.3.1.1 When the pilot initiates communications with ATC, a rapid response may be obtained by stating "WEATHER DEVIATION REQUIRED" to indicate that priority is desired on the frequency and for ATC response. When necessary, the pilot should initiate the communications using the urgency call "PAN PAN" (preferable spoken three times).

2.1.2.3.1.2 The pilot shall inform ATC when weather deviation is no longer required, or when weather deviation has been completed and the aircraft has return to its cleared route.

2.1.2.3.2 Actions to be taken when Controller - Pilot Communications are established.

2.1.2.3.2.1 The pilot should notify ATC and request clearance to deviate from track, advising, when possible, the extent of the deviation expected.

2.1.2.3.2.2 ATC should take one of the following actions:

- a) when appropriate separation can be applied, issue clearance to deviate from track; or
- b) if there is conflicting traffic and ATC is unable to establish appropriate separation, ATC shall:
  - i. advise the pilot of inability to issue clearance for the requested deviation;
  - ii. advise the pilot of conflicting traffic; and
  - iii. request the pilots intentions.

2.1.2.3.2.3 The pilot should take the following actions:

- a) comply with the ATC clearance issued; or
- b) advise ATC of intentions and execute the procedures detailed in 2.3.3

2.1.2.3.3 Actions to be taken if a revised ATC clearance cannot be obtained

**Note:** The provisions of this section apply to situations where a pilot needs to exercise the authority of a pilot - in - command under the provisions of ICAO Annex 2, 2.3.1

2.1.2.3.3.1 If the aircraft is required to deviate from track to avoid adverse meteorological conditions and prior clearance cannot be obtained, an ATC clearance shall be obtained at the earliest possible time. Until an ATC clearance is received, the pilot shall take the following actions:

- a) if possible, deviate away from an organized track or route system;
- b) establish communication with and alert nearby aircraft broadcasting, all suitable intervals: aircraft identification, flight level, position (including ATS route designator or the track code) and intentions, on the frequency in use and on 121.500 MHZ (or, as a back - up, on the inter - pilot air - to - air frequency 123.450 MHZ);
- c) watch for the conflicting traffic both visually and by reference to ACAS (if equipped);

**Note:** If, as a result of action taken under provision of 2.1.2.3.3.1 b) and c), the pilot determines that there is another aircraft at or near the same flight level with which may occur, then the pilot is expected to adjust the path of the aircraft, as necessary, to avoid conflict.

- d) turn on all aircraft exterior lights (commensurate with appropriate operating limitations);
- e) for deviations of less than 19 KM (10 NM) remain at a level assigned by ATC;
- f) for deviation greater than 19 KM (10 NM), when the aircraft is approximately 19 KM (10 NM) from track, initiate a level change in accordance with Table 1;

Table 1

Route centre line track	Deviation > 19 KM (10 NM)	Level Change
EAST 000° - 179° magnetic	LEFT	DESCEND 90 M (300 FT)
	RIGHT	CLIMB 90 M (300 FT)
WEST 180° - 359° magnetic	LEFT	CLIMB 90M (300 FT)
	RIGHT	DESCEND 90 M (300 FT)

- g) when returning to track, be at its assigned flight level when the aircraft is within approximately 19 KM (10 NM) of the centre line; and
- h) if contact was not established prior to deviating, continue to attempt to contact ATC to obtain a clearance. If contact was established, continue to keep ATC advised of intentions and obtain essential traffic information.

2.1.2.3.4 Procedures for Strategic Lateral Offsets in oceanic and remote continental airspace.

**Note 1:** ICAO Annex 2, 3.6.2.1 requires authorization for the application of strategic lateral offsets from the appropriate ATS authority responsible for the airspace concerned.

**Note 2:** The following incorporates lateral offset procedures for both the migration of the increasing lateral overlap probability due to increased navigation accuracy, and wake turbulence encounters.

**Note 3:** The use of highly accurate navigation systems (such as the global navigation satellite system (GNSS)) by an increasing proportion of the aircraft population has had the effect of reducing the magnitude of lateral deviations from the route centre line and, consequently, increasing the probability of a collision, should a loss of vertical separation between aircraft on the same route occur.

2.1.2.3.4.1 The following shall be taken into account by the appropriate ATS authority when authorizing the use of strategic lateral offsets in a particular airspace:

- a) strategic lateral offsets shall only be authorized in en - route oceanic or remote continental airspace. Where part of the airspace in question is within radar coverage, transiting aircraft should normally be allowed to indicate or continue offset tracking;
- b) strategic lateral offsets may be authorized for the following types of routes (including where routes or route system intersect):
  - i. uni - directional and bi - directional
  - ii. parallel route system where the spacing between route centre lines is not less than 55.5 KM (30 NM);
- c) in some instances it may be necessary to impose restrictions on the use of strategic lateral offsets, e.g. where their application may be inappropriate for reasons related to obstacle clearance;
- d) strategic lateral offset procedures should be implemented on a regional basis after coordination between all States involved;
- e) the routes or airspace where application of strategic lateral offsets is authorized, and the procedures to be followed by pilots, shall be promulgated in the aeronautical information publications (AIP); and
- f) air traffic controllers shall be made aware of the airspace within which strategic lateral offsets are authorized.

2.1.2.3.4.1.1 The decision to apply a strategic lateral offset shall be the responsible of the flight crew. The flight crew shall only apply strategic lateral offsets in airspace where such offsets have been authorized by the appropriate ATS authority and when the aircraft is equipped with automatic offset tracking capability.

2.1.2.3.4.1.2 The strategic lateral offset shall be established at a distance of 1.85 KM (1 NM) or 3.7 KM (2 NM) to the right of the centre line relative to the direction of flight.

**Note 1:** Pilots may contact other aircraft on the inter - pilot air - to - air frequency 123.450 MHZ to coordinate offsets.

**Note 2:** The strategic lateral offset procedure has been designated to include offsets to mitigate the effects of wake turbulence of preceding aircraft. If wake turbulence needs to be avoided, one of the three available options (centreline, 1.85 KM (1 NM) or 3.7 KM (2 NM) right offset) may be used.

**Note 3:** Pilots are not required to inform ATC that a strategic lateral offset is being applied.

ATS AIRSPACES WITHIN SAL TMA

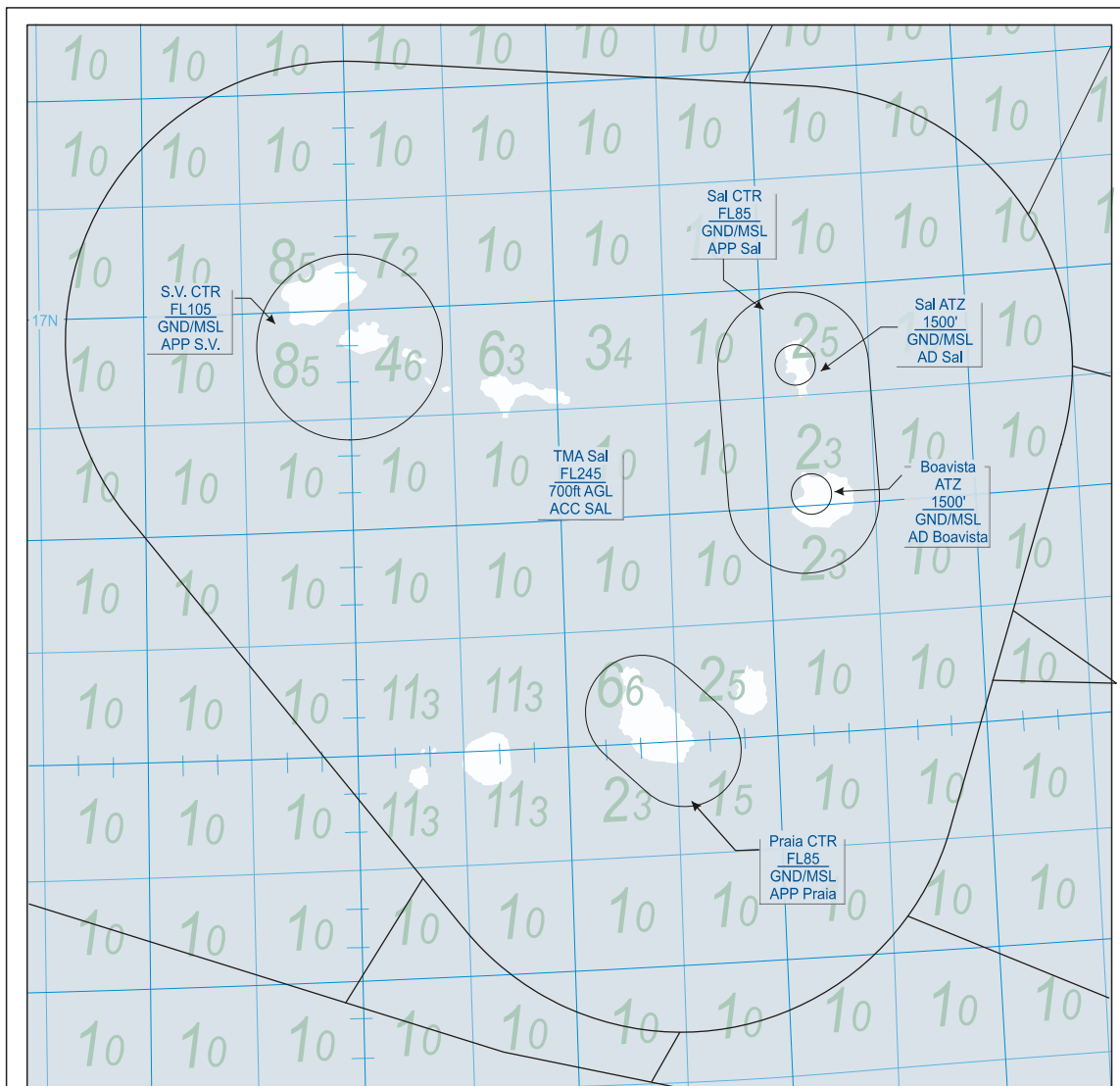

**Sal TMA limits**

Lateral: Area delimited by three arcs of circle of 80NM radius centered on CVS VOR (N164412 W0225704), SNT VOR (N145621 W0232856) and SVT NDB (N164943 W0250354) and the tangents to these arcs.  
Vertical: 700 ft AGL to FL245. Class A above FL195, class C below FL195.

**Sal CTR limits**

Lateral: Area delimited by two arcs of circle of 20NM radius centered on GVAC ARP (N164431W0225656) and GVBA ARP (N160814W0225319) and the tangents to these arcs.  
Vertical: GND/MSL to FL85. Class C.

**Praia CTR limits**

Lateral: Area delimited by two arcs of circle of 15NM radius centered on GVNP ARP (N145628 W0232905) and 151000N0234000W and the tangents to these arcs.  
Vertical: GND/MSL to FL85. Class C.

**São Vicente CTR limits**

Lateral: Arc of circle of 25NM radius centered at GVSV ARP (N165001 W0250325).  
Vertical: GND/MSL to FL105. Class C.

**Sal ATZ limits**

Lateral: Area delimited by a circle of 5NM radius centered on GVAC ARP (N164431W0225656).  
Vertical: GND/MSL to 1500'. Class C.

**Boavista ATZ limits**

Lateral: Area delimited by a circle of 5NM radius centered on GVBA ARP (N160814W0225319).  
Vertical: GND/MSL to 1500'. Class C.



AREA MINIMUM ALTITUDES OF SAL FIR AND MINIMUM SECTOR ALTITUDES FOR THE AIRPORTS WITHIN SAL TMA

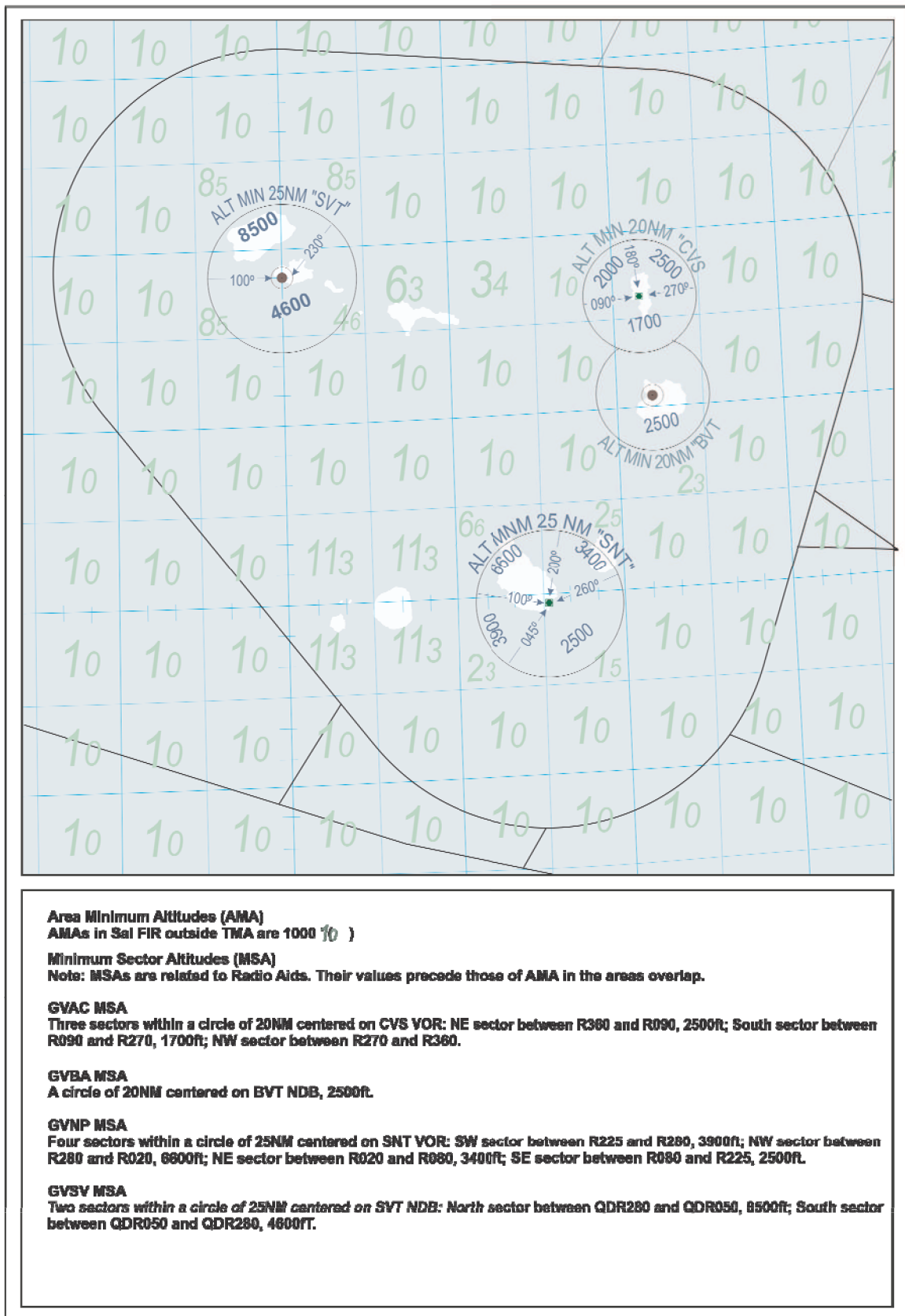

**INTENTIONALLY LEFT BLANK**

---

**ENR 2.2 OTHER REGULATED AIRSPACE**

NIL

**INTENTIONALLY LEFT BLANK**

ENR 3. ATS ROUTES

ENR 3.1 LOWER ATS ROUTES

Route Designator/ (RNP/RNAV Type)		Route Usage Notes							
Significant Point Name		Significant Point Coordinates							
(RNP/RNAV Type)	Track MAG ↓ / ↑	Dist	COP	Upper limit / lower limit	Minimum flight altitude	Lateral limits	IFR cruising levels max/min		Remarks/ Controlling Unit/ SATVOICE number, RCP and RSP limitations Airspace Class
							↓	↑	
<b>A602</b>									
▲	MOGSA	144118N 0201241W							SAL ACC 128.300 MHZ 127.100 MHZ 126.400 MHZ
		318°/ 138°	114.0 NM		FL 245 / 3000 FT AMSL	40 NM	even	odd	FL 245 / FL 195 Class A FL 195 / 8500 FT AMSL Class C
▲	RAMOL	155142N 0214606W							
		318°/ 138°	86.0 NM		FL 245 / 3000 FT AMSL	10 NM	even	odd	FL 245 / FL 195 Class A FL 195 / 8500 FT AMSL Class C
▲	SAL / AMILCAR CABRAL VOR/DME (CVS)	164412N 0225703W							

Route Designator/ (RNP/RNAV Type)		Route Usage Notes									
Significant Point Name		Significant Point Coordinates									
(RNP/RNAV Type)		Track MAG ↓ / ↑	Dist	COP	Upper limit / lower limit	Minimum flight altitude	Lateral limits	IFR cruising levels max/min		Remarks/ Controlling Unit/ SATVOICE number, RCP and RSP limitations Airspace Class	
								↓	↑		
<b>B623</b>											
▲	IPERA	202154N 0204200W									SAL ACC 128.300 MHZ 127.100 MHZ 126.400 MHZ
		219°/ 040°	173.0 NM		FL 245 / 3000 FT AMSL		90 NM	even	odd		FL 245 / FL 195 Class A FL 195 / 8500 FT AMSL Class C
▲	PISPU	175320N 0221453W									
		220°/ 041°	80.0 NM		FL 245 / 3000 FT AMSL		10 NM	even	odd		FL 245 / FL 195 Class A FL 195 / 8500 FT AMSL Class C
▲	SAL / AMILCAR CABRAL VOR/DME (CVS)	164412N 0225703W									
		216°/ 037°	188.0 NM		FL 245 / 3000 FT AMSL		10 NM	even	odd		FL 245 / FL 195 Class A FL 195 / 8500 FT AMSL Class C
▲	AGTIL	135354N 0242034W									
		217°/ 037°	14.0 NM		FL 245 / 3000 FT AMSL		90 NM	even	odd		FL 245 / FL 195 Class A FL 195 / 8500 FT AMSL Class C
▲	ONOB	134136N 0242630W									

Route Designator/ (RNP/RNAV Type)		Route Usage Notes							
Significant Point Name		Significant Point Coordinates							
(RNP/RNAV Type)	Track MAG ↓ / ↑	Dist	COP	Upper limit / lower limit	Minimum flight altitude	Lateral limits	IFR cruising levels max/min		Remarks/ Controlling Unit/ SATVOICE number, RCP and RSP limitations Airspace Class
							↓	↑	
<b>R976</b>									
▲	LUMPO	154048N 020000W							SAL ACC 128.300 MHZ 127.100 MHZ 126.400 MHZ
		301°/ 121°	101.0 NM		FL 245 / 3000 FT AMSL	40 NM	even	odd	FL 245 / FL 195 Class A FL 195 / 8500 FT AMSL Class C
▲	POLMO	161629N 0213834W							
		301°/ 121°	80.0 NM		FL 245 / 3000 FT AMSL	10 NM	even	odd	FL 245 / FL 195 Class A FL 195 / 8500 FT AMSL Class C
▲	SAL / AMILCAR CABRAL VOR/DME (CVS)	164412N 0225703W							

Route Designator/ (RNP/RNAV Type)		Route Usage Notes								
Significant Point Name		Significant Point Coordinates								
(RNP/RNAV Type)	Track MAG ↓ / ↑	Dist	COP	Upper limit / lower limit	Minimum flight altitude	Lateral limits	IFR cruising levels max/min		Remarks/ Controlling Unit/ SATVOICE number, RCP and RSP limitations Airspace Class	
							↓	↑		
<b>W11</b>		<b>Route Remarks:</b> Transition UW11 / UN857								
▲	PINPO	173905N 0215608W						SAL ACC 128.300 MHZ 127.100 MHZ 126.400 MHZ		
		237°/ 057°	80.0 NM		FL 245 / FL 195	3000 FT ALT	10 NM	even	odd	Class A
▲	SAL / AMILCAR CABRAL VOR/DME (CVS)	164412N 0225703W								



Route Designator/ (RNP/RNAV Type)		Route Usage Notes								
Significant Point Name		Significant Point Coordinates								
(RNP/RNAV Type)	Track MAG ↓ / ↑	Dist	COP	Upper limit / lower limit	Minimum flight altitude	Lateral limits	IFR cruising levels max/min		Remarks/ Controlling Unit/ SATVOICE number, RCP and RSP limitations Airspace Class	
							↓	↑		
<b>W12</b>										
▲	SAL / AMILCAR CABRAL VOR/DME (CVS)	164412N 0225703W						SAL ACC 128.300 MHZ 127.100 MHZ 126.400 MHZ		
		207°/ 027°	112.0 NM		FL 245 / FL 195	3000 FT ALT	10 NM	even	odd	Class A
▲	PRAIA VOR/DME (SNT)	145621N 0232856W								

Route Designator/ (RNP/RNAV Type)		Route Usage Notes								
Significant Point Name		Significant Point Coordinates								
(RNP/RNAV Type)	Track MAG ↓ / ↑	Dist	COP	Upper limit / lower limit	Minimum flight altitude	Lateral limits	IFR cruising levels max/min		Remarks/ Controlling Unit/ SATVOICE number, RCP and RSP limitations Airspace Class	
							↓	↑		
<b>W13</b>		<b>Route Remarks: Transition UN873</b>								
▲	SAL / AMILCAR CABRAL VOR/DME (CVS)	164412N 0225703W						SAL ACC 128.300 MHZ 127.100 MHZ 126.400 MHZ		
		220°/ 041°	185.0 NM		FL 245 / FL 195	3000 FT ALT	10 NM	even	odd	Class A
▲	BULVO	140228N 0243012W								

Route Designator/ (RNP/RNAV Type)		Route Usage Notes								
Significant Point Name		Significant Point Coordinates								
(RNP/RNAV Type)	Track MAG ↓ / ↑	Dist	COP	Upper limit / lower limit	Minimum flight altitude	Lateral limits	IFR cruising levels max/min		Remarks/ Controlling Unit/ SATVOICE number, RCP and RSP limitations Airspace Class	
							↓	↑		
<b>W14</b>										
▲	SAL / AMILCAR CABRAL VOR/DME (CVS)	164412N 0225703W						SAL ACC 128.300 MHZ 127.100 MHZ 126.400 MHZ		
		284°/ 104°	122.0 NM		FL 245 / FL 195	3000 FT ALT	10 NM	even	odd	Class A
▲	SAO VICENTE NDB (SVT)	164945N 0250353W								

Route Designator/ (RNP/RNAV Type)		Route Usage Notes								
Significant Point Name		Significant Point Coordinates								
(RNP/RNAV Type)	Track MAG ↓ / ↑	Dist	COP	Upper limit / lower limit	Minimum flight altitude	Lateral limits	IFR cruising levels max/min		Remarks/ Controlling Unit/ SATVOICE number, RCP and RSP limitations Airspace Class	
							↓	↑		
<b>W15</b>		<b>Route Remarks:</b> Transition UR976								
▲	SAL / AMILCAR CABRAL VOR/DME (CVS)	164412N 0225703W								SAL ACC 128.300 MHZ 127.100 MHZ 126.400 MHZ
		318°/ 138°	141.0 NM		FL 245 / FL 195	3000 FT ALT	10 NM	even	odd	Class A
▲	KESIK	180928N 0245513W								

Route Designator/ (RNP/RNAV Type)		Route Usage Notes								
Significant Point Name		Significant Point Coordinates								
(RNP/RNAV Type)	Track MAG ↓ / ↑	Dist	COP	Upper limit / lower limit	Minimum flight altitude	Lateral limits	IFR cruising levels max/min		Remarks/ Controlling Unit/ SATVOICE number, RCP and RSP limitations Airspace Class	
							↓	↑		
<b>W21</b>		<b>Route Remarks: Transition UW21 - UN873</b>								
▲	PISPU	175320N 0221453W								SAL ACC 128.300 MHZ 127.100 MHZ 126.400 MHZ
		209°/ 030°	112.0 NM		FL 245 / FL 195	3000 FT ALT	10 NM	even	odd	Class A
▲	BOA VISTA / RABIL NDB (BVT)	160803N 0225317W								

Route Designator/ (RNP/RNAV Type)		Route Usage Notes								
Significant Point Name		Significant Point Coordinates								
(RNP/RNAV Type)	Track MAG ↓ / ↑	Dist	COP	Upper limit / lower limit	Minimum flight altitude	Lateral limits	IFR cruising levels max/min		Remarks/ Controlling Unit/ SATVOICE number, RCP and RSP limitations Airspace Class	
							↓	↑		
<b>W22</b>		<b>Route Remarks:</b> Transition UW22 - UW11 - UN857								
▲	PINPO	173905N 0215608W						SAL ACC 128.300 MHZ 127.100 MHZ 126.400 MHZ		
		221°/ 042°	106.0 NM		FL 245 / FL 195	3000 FT ALT	10 NM	even	odd	Class A
▲	BOA VISTA / RABIL NDB (BVT)	160803N 0225317W								

Route Designator/ (RNP/RNAV Type)		Route Usage Notes								
Significant Point Name		Significant Point Coordinates								
(RNP/RNAV Type)	Track MAG ↓ / ↑	Dist	COP	Upper limit / lower limit	Minimum flight altitude	Lateral limits	IFR cruising levels max/min		Remarks/ Controlling Unit/ SATVOICE number, RCP and RSP limitations Airspace Class	
							↓	↑		
<b>W23</b>										
▲	BOA VISTA / RABIL NDB (BVT)	160803N 0225317W						SAL ACC 128.300 MHZ 127.100 MHZ 126.400 MHZ		
		216°/ 037°	80.0 NM		FL 245 / FL 195	3000 FT ALT	10 NM	even	odd	Class A
▲	PRAIA VOR/DME (SNT)	145621N 0232856W								

Route Designator/ (RNP/RNAV Type)		Route Usage Notes								
Significant Point Name		Significant Point Coordinates								
(RNP/RNAV Type)	Track MAG ↓ / ↑	Dist	COP	Upper limit / lower limit	Minimum flight altitude	Lateral limits	IFR cruising levels max/min		Remarks/ Controlling Unit/ SATVOICE number, RCP and RSP limitations Airspace Class	
							↓	↑		
<b>W31</b>										
▲	MOGSA	144118N 0201241W							SAL ACC 128.300 MHZ 127.100 MHZ 126.400 MHZ	
		285°/ 105°	109.0 NM		FL 245 / 3000 FT AMSL		40 NM	odd	even	FL 245 / FL 195 Class A FL 195 / 8500 FT AMSL Class C
▲	SONVA	145014N 0220438W								
		285°/ 105°	82.0 NM		FL 245 / 3000 FT AMSL		10 NM	even	odd	FL 245 / FL 195 Class A FL 195 / 8500 FT AMSL Class C
▲	PRAIA VOR/DME (SNT)	145621N 0232856W								



Route Designator/ (RNP/RNAV Type)		Route Usage Notes							
Significant Point Name		Significant Point Coordinates							
(RNP/RNAV Type)	Track MAG ↓ / ↑	Dist	COP	Upper limit / lower limit	Minimum flight altitude	Lateral limits	IFR cruising levels max/min		Remarks/ Controlling Unit/ SATVOICE number, RCP and RSP limitations Airspace Class
							↓	↑	
<b>W32</b>									
▲	BORTA	135514N 0204345W							SAL ACC 128.300 MHZ 127.100 MHZ 126.400 MHZ
		302°/ 122°	91.0 NM		FL 245 / 3000 FT AMSL	40 NM	even	odd	FL 245 / FL 195 Class A FL 195 / 8500 FT AMSL Class C
▲	VONTO	142802N 0221134W							
			80.0 NM		FL 245 / 3000 FT AMSL	10 NM	even	odd	FL 245 / FL 195 Class A FL 195 / 8500 FT AMSL Class C
▲	PRAIA VOR/DME (SNT)	145621N 0232856W							

Route Designator/ (RNP/RNAV Type)		Route Usage Notes								
Significant Point Name		Significant Point Coordinates								
(RNP/RNAV Type)	Track MAG ↓ / ↑	Dist	COP	Upper limit / lower limit	Minimum flight altitude	Lateral limits	IFR cruising levels max/min		Remarks/ Controlling Unit/ SATVOICE number, RCP and RSP limitations Airspace Class	
							↓	↑		
<b>W33</b>		<b>Route Remarks: Transition UW33 - UB623</b>								
▲	PRAIA VOR/DME (SNT)	145621N 0232856W						SAL ACC 128.300 MHZ 127.100 MHZ 126.400 MHZ		
		230°/ 051°	80.0 NM		FL 245 / FL 195	3000 FT ALT	10 NM	even	odd	Class A
▲	AGTIL	135354N 0242034W								

Route Designator/ (RNP/RNAV Type)		Route Usage Notes								
Significant Point Name		Significant Point Coordinates								
(RNP/RNAV Type)	Track MAG ↓ / ↑	Dist	COP	Upper limit / lower limit	Minimum flight altitude	Lateral limits	IFR cruising levels max/min		Remarks/ Controlling Unit/ SATVOICE number, RCP and RSP limitations Airspace Class	
							↓	↑		
<b>W34</b>		<b>Route Remarks: Transition UW34 - UN873</b>								
▲	PRAIA VOR/DME (SNT)	145621N 0232856W						SAL ACC 128.300 MHZ 127.100 MHZ 126.400 MHZ		
		239°/ 060°	80.0 NM		FL 245 / FL 195	3000 FT ALT	10 NM	even	odd	Class A
▲	BULVO	140228N 0243012W								

Route Designator/ (RNP/RNAV Type)		Route Usage Notes								
Significant Point Name		Significant Point Coordinates								
(RNP/RNAV Type)	Track MAG ↓ / ↑	Dist	COP	Upper limit / lower limit	Minimum flight altitude	Lateral limits	IFR cruising levels max/min		Remarks/ Controlling Unit/ SATVOICE number, RCP and RSP limitations Airspace Class	
							↓	↑		
<b>W35</b>										
▲	SAO VICENTE NDB (SVT)	164945N 0250353W						SAL ACC 128.300 MHZ 127.100 MHZ 126.400 MHZ		
		152°/ 333°	146.0 NM		FL 245 / FL 195	85 FL ALT	10 NM	odd	even	Class A
▲	PRAIA VOR/DME (SNT)	145621N 0232856W								

Route Designator/ (RNP/RNAV Type)		Route Usage Notes							
Significant Point Name		Significant Point Coordinates							
(RNP/RNAV Type)	Track MAG ↓ / ↑	Dist	COP	Upper limit / lower limit	Minimum flight altitude	Lateral limits	IFR cruising levels max/min		Remarks/ Controlling Unit/ SATVOICE number, RCP and RSP limitations Airspace Class
							↓	↑	
<b>W41</b>		<b>Route Remarks: Transition UW41 - UN741</b>							
▲	LININ	180905N 0244524W						SAL ACC 128.300 MHZ 127.100 MHZ 126.400 MHZ	
		204° / -	81.0 NM		FL 245 / FL 195	85 FL ALT	10 NM	even	Class A
▲	SAO VICENTE NDB (SVT)	164945N 0250353W							

Route Designator/ (RNP/RNAV Type)		Route Usage Notes							
Significant Point Name		Significant Point Coordinates							
(RNP/RNAV Type)	Track MAG ↓ / ↑	Dist	COP	Upper limit / lower limit	Minimum flight altitude	Lateral limits	IFR cruising levels max/min		Remarks/ Controlling Unit/ SATVOICE number, RCP and RSP limitations Airspace Class
							↓	↑	
<b>W42</b>		<b>Route Remarks: Transition UW42 - UN866</b>							
▲	MOPAC	180720N 0240250W						SAL ACC 128.300 MHZ 127.100 MHZ 126.400 MHZ	
		- /048°	97.0 NM		FL 245 / FL 195	85 FL ALT	10 NM		even Class A
▲	SAO VICENTE NDB (SVT)	164945N 0250353W							

Route Designator/ (RNP/RNAV Type)		Route Usage Notes								
Significant Point Name		Significant Point Coordinates								
(RNP/RNAV Type)	Track MAG ↓ / ↑	Dist	COP	Upper limit / lower limit	Minimum flight altitude	Lateral limits	IFR cruising levels max/min		Remarks/ Controlling Unit/ SATVOICE number, RCP and RSP limitations Airspace Class	
							↓	↑		
<b>W43</b>		<b>Route Remarks: Transition UW43 - UN873</b>								
▲	NEMDO	180557N 0233154W						SAL ACC 128.300 MHZ 127.100 MHZ 126.400 MHZ		
		240°/ 060°	116.0 NM		FL 245 / FL 195	3000 FT ALT	10 NM	even	odd	Class A
▲	SAO VICENTE NDB (SVT)	164945N 0250353W								

Route Designator/ (RNP/RNAV Type)		Route Usage Notes							
Significant Point Name		Significant Point Coordinates							
(RNP/RNAV Type)	Track MAG ↓ / ↑	Dist	COP	Upper limit / lower limit	Minimum flight altitude	Lateral limits	IFR cruising levels max/min		Remarks/ Controlling Unit/ SATVOICE number, RCP and RSP limitations Airspace Class
							↓	↑	
<b>W45</b>		<b>Route Remarks: Transition UW45 - UN866</b>							
▲	SAO VICENTE NDB (SVT)	164945N 0250353W							SAL ACC 128.300 MHZ 127.100 MHZ 126.400 MHZ
		- /035°	90.0 NM		FL 245 / FL 195	3000 FT ALT	10 NM		odd Class A
▲	DENER	152724N 0254132W							



Route Designator/ (RNP/RNAV Type)		Route Usage Notes							
Significant Point Name		Significant Point Coordinates							
(RNP/RNAV Type)	Track MAG ↓ / ↑	Dist	COP	Upper limit / lower limit	Minimum flight altitude	Lateral limits	IFR cruising levels max/min		Remarks/ Controlling Unit/ SATVOICE number, RCP and RSP limitations Airspace Class
							↓	↑	
<b>W46</b>		<b>Route Remarks: Transition UW46 - UN741</b>							
▲	SAO VICENTE NDB (SVT)	164945N 0250353W						SAL ACC 128.300 MHZ 127.100 MHZ 126.400 MHZ	
		251° -	81.0 NM		FL 245 / FL 195	3000 FT ALT	10 NM	even	Class A
▲	EDIPA	160755N 0261600W							

Route Designator/ (RNP/RNAV Type)		Route Usage Notes							
Significant Point Name		Significant Point Coordinates							
(RNP/RNAV Type)	Track MAG ↓ / ↑	Dist	COP	Upper limit / lower limit	Minimum flight altitude	Lateral limits	IFR cruising levels max/min		Remarks/ Controlling Unit/ SATVOICE number, RCP and RSP limitations Airspace Class
							↓	↑	
<b>W47</b>		<b>Route Remarks:</b> Transition UW47 - UR976							
▲	EVKAS	174803N 0260116W						SAL ACC 128.300 MHZ 127.100 MHZ 126.400 MHZ	
		149°/ 328°	80.0 NM	FL 245 / FL 195	85 FL ALT	10 NM	odd	even	Class A
▲	SAO VICENTE NDB (SVT)	164945N 0250353W							

ENR 3.2 UPPER ATS ROUTES

Route Designator/ (RNP/RNAV Type)		Route Usage Notes						
Significant Point Name		Significant Point Coordinates						
(RNP/RNAV Type)	Track MAG ↓/↑	Dist	COP	Upper limit / lower limit	Lateral limits	IFR cruising levels max/min		Remarks/ Controlling Unit/ SATVOICE number, RCP and RSP limitations Airspace Class
						↓	↑	
<b>UA602</b>								
▲	MOGSA	144118N	0201241W					SAL ACC 128.300 MHZ 127.100 MHZ 126.400 MHZ
		318°/ 138°	122.0 NM		UNL / FL 245		even odd	Class A
▲	ORABI	155618N	0215212W					
		318°/ 138°	79.0 NM		UNL / FL 245		even odd	Class A
▲	SAL / AMILCAR CABRAL VOR/DME (CVS)	164412N	0225703W					

Route Designator/ (RNP/RNAV Type)		Route Usage Notes						
Significant Point Name		Significant Point Coordinates						
(RNP/RNAV Type)	Track MAG ↓/↑	Dist	COP	Upper limit / lower limit	Lateral limits	IFR cruising levels max/min		Remarks/ Controlling Unit/ SATVOICE number, RCP and RSP limitations Airspace Class
						↓	↑	
<b>UB623</b>								
▲	SAL / AMILCAR CABRAL VOR/DME (CVS)	164412N	0225703W					SAL ACC 128.300 MHZ 127.100 MHZ 126.400 MHZ
		216°/ 037°	202.0 NM		FL 280 / FL 245		even odd	Class A
▲	ONOBI	134136N	0242630W					

Route Designator/ (RNP/RNAV Type)		Route Usage Notes						
Significant Point Name		Significant Point Coordinates						
(RNP/RNAV Type)	Track MAG ↓/↑	Dist	COP	Upper limit / lower limit	Lateral limits	IFR cruising levels max/min		Remarks/ Controlling Unit/ SATVOICE number, RCP and RSP limitations Airspace Class
						↓	↑	
<b>UR976</b>								
▲	LUMPO	154048N	0200000W					SAL ACC 128.300 MHZ 127.100 MHZ 126.400 MHZ
		301°/ 121°	103.0 NM		UNL / FL 245		even odd	Class A
▲	UGAMA	161712N	0214012W					
		300°/ 121°	78.0 NM		UNL / FL 245		even odd	Class A
▲	SAL / AMILCAR CABRAL VOR/DME (CVS)	164412N	0225703W					
		318°/ 138°	97.0 NM		UNL / FL 245		even odd	Class A

Route Designator/ (RNP/RNAV Type)		Route Usage Notes							
Significant Point Name		Significant Point Coordinates							
(RNP/RNAV Type)	Track MAG ↓/↑	Dist	COP	Upper limit / lower limit	Lateral limits	IFR cruising levels max/min		Remarks/ Controlling Unit/ SATVOICE number, RCP and RSP limitations Airspace Class	
						↓	↑		
▲ IREDO		174306N	0241812W						
		318° 138°	125.0 NM		UNL / FL 245		even	odd	Class A
▲ GAMB		185706N	0260342W						
		318° 138°	260.0 NM		UNL / FL 245		even	odd	Class A
▲ ULTEM		212946N	0294800W						

Route Designator/ (RNP/RNAV Type)		Route Usage Notes							
Significant Point Name		Significant Point Coordinates							
(RNP/RNAV Type)	Track MAG ↓/↑	Dist	COP	Upper limit / lower limit	Lateral limits	IFR cruising levels max/min		Remarks/ Controlling Unit/ SATVOICE number, RCP and RSP limitations Airspace Class	
						↓	↑		
UW11		<u>Route Remarks:</u> Transition UN857							
▲ GUNET		193500N	0194406W					SAL ACC 128.300 MHZ 127.100 MHZ 126.400 MHZ	
		238° 057°	171.0 NM		UNL / FL 245		even	odd	Class A
▲ PINPO		173905N	0215608W						
		237° 057°	80.0 NM		UNL / FL 245		even	odd	Class A
▲ SAL / AMILCAR CABRAL VOR/DME (CVS)		164412N	0225703W						

Route Designator/ (RNP/RNAV Type)		Route Usage Notes							
Significant Point Name		Significant Point Coordinates							
(RNP/RNAV Type)	Track MAG ↓/↑	Dist	COP	Upper limit / lower limit	Lateral limits	IFR cruising levels max/min		Remarks/ Controlling Unit/ SATVOICE number, RCP and RSP limitations Airspace Class	
						↓	↑		
UW21		<u>Route Remarks:</u> Transition UN873							
▲ PISPU		175320N	0221453W					SAL ACC 128.300 MHZ 127.100 MHZ 126.400 MHZ	
		209° 030°	112.0 NM		UNL / FL 245		even	odd	Class A
▲ BOA VISTA / RABIL NDB (BVT)		160803N	0225317W						

Route Designator/ (RNP/RNAV Type)		Route Usage Notes						
Significant Point Name		Significant Point Coordinates						
(RNP/RNAV Type)	Track MAG ↓/↑	Dist	COP	Upper limit / lower limit	Lateral limits	IFR cruising levels max/min		Remarks/ Controlling Unit/ SATVOICE number, RCP and RSP limitations Airspace Class
						↓	↑	
<b>UW22</b>		<b>Route Remarks: Transition UN857</b>						
▲	PINPO	173905N	0215608W					SAL ACC 128.300 MHZ 127.100 MHZ 126.400 MHZ
		221°/ 042°	106.0 NM		UNL / FL 245		even odd	Class A
▲	BOA VISTA / RABIL NDB (BVT)	160803N	0225317W					

Route Designator/ (RNP/RNAV Type)		Route Usage Notes						
Significant Point Name		Significant Point Coordinates						
(RNP/RNAV Type)	Track MAG ↓/↑	Dist	COP	Upper limit / lower limit	Lateral limits	IFR cruising levels max/min		Remarks/ Controlling Unit/ SATVOICE number, RCP and RSP limitations Airspace Class
						↓	↑	
<b>UW23</b>								
▲	BOA VISTA / RABIL NDB (BVT)	160803N	0225317W					SAL ACC 128.300 MHZ 127.100 MHZ 126.400 MHZ
		216°/ 037°	80.0 NM		UNL / FL 245		even odd	Class A
▲	PRAIA VOR/DME (SNT)	145621N	0232856W					

Route Designator/ (RNP/RNAV Type)		Route Usage Notes						
Significant Point Name		Significant Point Coordinates						
(RNP/RNAV Type)	Track MAG ↓/↑	Dist	COP	Upper limit / lower limit	Lateral limits	IFR cruising levels max/min		Remarks/ Controlling Unit/ SATVOICE number, RCP and RSP limitations Airspace Class
						↓	↑	
<b>UW31</b>								
▲	MOGSA	144118N	0201241W					SAL ACC 128.300 MHZ 127.100 MHZ 126.400 MHZ
		285°/ 105°	190.0 NM		UNL / FL 245		even odd	Class A
▲	PRAIA VOR/DME (SNT)	145621N	0232856W					

Route Designator/ (RNP/RNAV Type)		Route Usage Notes							
Significant Point Name		Significant Point Coordinates							
(RNP/RNAV Type)	Track MAG ↓/↑	Dist	COP	Upper limit / lower limit	Lateral limits	IFR cruising levels max/min		Remarks/ Controlling Unit/ SATVOICE number, RCP and RSP limitations Airspace Class	
						↓	↑		
<b>UW32</b>									
▲	BORTA	135514N 0204345W					SAL ACC 128.300 MHZ 127.100 MHZ 126.400 MHZ		
		302°/ 122°	171.0 NM		UNL / FL 245		even	odd	Class A
▲	PRAIA VOR/DME (SNT)	145621N 0232856W							

Route Designator/ (RNP/RNAV Type)		Route Usage Notes							
Significant Point Name		Significant Point Coordinates							
(RNP/RNAV Type)	Track MAG ↓/↑	Dist	COP	Upper limit / lower limit	Lateral limits	IFR cruising levels max/min		Remarks/ Controlling Unit/ SATVOICE number, RCP and RSP limitations Airspace Class	
						↓	↑		
<b>UW33</b>									
<u>Route Remarks:</u> Transition UB623									
▲	PRAIA VOR/DME (SNT)	145621N 0232856W					SAL ACC 128.300 MHZ 127.100 MHZ 126.400 MHZ		
		230°/ 051°	80.0 NM		UNL / FL 245		even	odd	Class A
▲	AGTIL	135354N 0242034W							

Route Designator/ (RNP/RNAV Type)		Route Usage Notes							
Significant Point Name		Significant Point Coordinates							
(RNP/RNAV Type)	Track MAG ↓/↑	Dist	COP	Upper limit / lower limit	Lateral limits	IFR cruising levels max/min		Remarks/ Controlling Unit/ SATVOICE number, RCP and RSP limitations Airspace Class	
						↓	↑		
<b>UW34</b>									
<u>Route Remarks:</u> Transition UN873									
▲	PRAIA VOR/DME (SNT)	145621N 0232856W					SAL ACC 128.300 MHZ 127.100 MHZ 126.400 MHZ		
		239°/ 060°	80.0 NM		UNL / FL 245		even	odd	Class A
▲	BULVO	140228N 0243012W							

Route Designator/ (RNP/RNAV Type)		Route Usage Notes							
Significant Point Name		Significant Point Coordinates							
(RNP/RNAV Type)	Track MAG ↓/↑	Dist	COP	Upper limit / lower limit	Lateral limits	IFR cruising levels max/min ↓   ↑		Remarks/ Controlling Unit/ SATVOICE number, RCP and RSP limitations Airspace Class	
<b>UW35</b>									
▲	SAO VICENTE NDB (SVT)	164945N 0250353W							SAL ACC 128.300 MHZ 127.100 MHZ 126.400 MHZ
		152°/ 333°	146.0 NM		UNL / FL 245		odd	even	Class A
▲	PRAIA VOR/DME (SNT)	145621N 0232856W							

Route Designator/ (RNP/RNAV Type)		Route Usage Notes							
Significant Point Name		Significant Point Coordinates							
(RNP/RNAV Type)	Track MAG ↓/↑	Dist	COP	Upper limit / lower limit	Lateral limits	IFR cruising levels max/min ↓   ↑		Remarks/ Controlling Unit/ SATVOICE number, RCP and RSP limitations Airspace Class	
<b>UW41</b>									
<u>Route Remarks:</u> Transition UN741									
▲	EDUMO	225454N 0233606W							SAL ACC 128.300 MHZ 127.100 MHZ 126.400 MHZ
		203°/ -	293.0 NM		UNL / FL 245		even		Class A
▲	LININ	180905N 0244524W							
		204°/ -	81.0 NM		UNL / FL 245		even		Class A
▲	SAO VICENTE NDB (SVT)	164945N 0250353W							

Route Designator/ (RNP/RNAV Type)		Route Usage Notes							
Significant Point Name		Significant Point Coordinates							
(RNP/RNAV Type)	Track MAG ↓/↑	Dist	COP	Upper limit / lower limit	Lateral limits	IFR cruising levels max/min ↓   ↑		Remarks/ Controlling Unit/ SATVOICE number, RCP and RSP limitations Airspace Class	
<b>UW42</b>									
<u>Route Remarks:</u> Transition UN866									
▲	MOPAC	180720N 0240250W							SAL ACC 128.300 MHZ 127.100 MHZ 126.400 MHZ
		- / 048°	97.0 NM		UNL / FL 245			odd	Class A
▲	SAO VICENTE NDB (SVT)	164945N 0250353W							

Route Designator/ (RNP/RNAV Type)		Route Usage Notes						
Significant Point Name		Significant Point Coordinates						
(RNP/RNAV Type)	Track MAG ↓/↑	Dist	COP	Upper limit / lower limit	Lateral limits	IFR cruising levels max/min		Remarks/ Controlling Unit/ SATVOICE number, RCP and RSP limitations Airspace Class
						↓	↑	
<b>UW43</b>		<b>Route Remarks:</b> Transition UW43 - UN873						
▲	IPERA	202154N 0204200W						SAL ACC 128.300 MHZ 127.100 MHZ 126.400 MHZ
		239° 060°	210.0 NM		UNL / FL 245		even odd	Class A
▲	NEMDO	180557N 0233154W						
		240° 060°	116.0 NM		UNL / FL 245		even odd	Class A
▲	SAO VICENTE NDB (SVT)	164945N 0250353W						

Route Designator/ (RNP/RNAV Type)		Route Usage Notes						
Significant Point Name		Significant Point Coordinates						
(RNP/RNAV Type)	Track MAG ↓/↑	Dist	COP	Upper limit / lower limit	Lateral limits	IFR cruising levels max/min		Remarks/ Controlling Unit/ SATVOICE number, RCP and RSP limitations Airspace Class
						↓	↑	
<b>UW45</b>		<b>Route Remarks:</b> Transition UN866						
▲	SAO VICENTE NDB (SVT)	164945N 0250353W						SAL ACC 128.300 MHZ 127.100 MHZ 126.400 MHZ
		- / 035°	90.0 NM		UNL / FL 245		odd	Class A
▲	DENER	152724N 0254132W						

Route Designator/ (RNP/RNAV Type)		Route Usage Notes						
Significant Point Name		Significant Point Coordinates						
(RNP/RNAV Type)	Track MAG ↓/↑	Dist	COP	Upper limit / lower limit	Lateral limits	IFR cruising levels max/min		Remarks/ Controlling Unit/ SATVOICE number, RCP and RSP limitations Airspace Class
						↓	↑	
<b>UW46</b>		<b>Route Remarks:</b> Transition UN741						
▲	SAO VICENTE NDB (SVT)	164945N 0250353W						SAL ACC 128.300 MHZ 127.100 MHZ 126.400 MHZ
		251° -	81.0 NM		UNL / FL 245		even	Class A
▲	EDIPA	160755N 0261600W						
		251° -	151.0 NM		UNL / FL 245		even odd	Class A
▲	KENOX	144836N 0282936W						



Route Designator/ (RNP/RNAV Type)		Route Usage Notes						
Significant Point Name		Significant Point Coordinates						
(RNP/RNAV Type)	Track MAG ↓/↑	Dist	COP	Upper limit / lower limit	Lateral limits	IFR cruising levels max/min		Remarks/ Controlling Unit/ SATVOICE number, RCP and RSP limitations Airspace Class
						↓	↑	
<b>UW47</b>		<b>Route Remarks: Transition UR976</b>						
▲	ULTEM	212946N 0294800W				SAL ACC 128.300 MHZ 127.100 MHZ 126.400 MHZ		
		148°/ 329°	308.0 NM		UNL / FL 245		odd even	Class A
▲	EVKAS	174803N 0260116W						
		149°/ 328°	80.0 NM		UNL / FL 245		odd even	Class A
▲	SAO VICENTE NDB (SVT)	164945N 0250353W						

**INTENTIONALLY LEFT BLANK**

ENR 3.3 AREA NAVIGATION (RNAV) ROUTES

Route Designator/ (RNP/RNAV Type)							
Significant Point Name		Significant Point Coordinates		Way Point: IDENT of VOR/DME (ELEV of DME antenna), BRG & DIST		Remarks/ Controlling Unit/ SATVOICE number, RCP and RSP limitations Airspace Class	
(RNP/RNAV Type)	MAG Track ↓ / ↑	Geodesic Distance	Upper limit / lower limit	IFR cruising levels max/min			
				↓	↑		
UN741 (RNP/RNAV)							
▲	EDUMO	225454N 0233606W				SAL ACC 128.300 MHZ 126.400 MHZ	
(RNAV 10)		275 NM	UNL / FL 245	even		Class A	
▲	GAMBA	185706N 0260342W					
(RNAV 10)		339° / -	285.1 NM	UNL / FL 245	even	Class A	
▲	KENOX	144836N 0282936W					

Route Designator/ (RNP/RNAV Type)		Significant Point Coordinates		Way Point: IDENT of VOR/DME (ELEV of DME antenna), BRG & DIST			Remarks/ Controlling Unit/ SATVOICE number, RCP and RSP limitations Airspace Class
(RNP/RNAV Type)	MAG Track ↓ / ↑	Geodesic Distance	Upper limit / lower limit	IFR cruising levels max/min			
UN857 (RNP/RNAV)				↓	↑		
▲	GUNET	193500N 0194406W					SAL ACC 128.300 MHZ 126.400 MHZ
(RNAV 10)		250 NM	UNL / FL 245	even	odd	Class A	
▲	ORABI	155618N 0215212W					
(RNAV 10)		167 NM	UNL / FL 245	even	odd	Class A	
▲	BOTNO	133000N 0231430W					

Route Designator/ (RNP/RNAV Type)		Significant Point Coordinates		Way Point: IDENT of VOR/DME (ELEV of DME antenna), BRG & DIST		Remarks/ Controlling Unit/ SATVOICE number, RCP and RSP limitations Airspace Class
(RNP/RNAV Type)	MAG Track ↓ / ↑	Geodesic Distance	Upper limit / lower limit	IFR cruising levels max/min		
				↓	↑	
<b>UN866 (RNP/RNAV)</b>						
▲	TENPA	212100N 0215824W				SAL ACC 128.300 MHZ 126.400 MHZ
(RNAV 10)			255 NM	UNL / FL 245		odd Class A
▲	IREDO	174306N 0241812W				
(RNAV 10)			234 NM	UNL / FL 245		odd Class A
▲	AMDOL	142112N 0262130W				

Route Designator/ (RNP/RNAV Type)		Significant Point Coordinates		Way Point: IDENT of VOR/DME (ELEV of DME antenna), BRG & DIST		Remarks/ Controlling Unit/ SATVOICE number, RCP and RSP limitations Airspace Class
(RNP/RNAV Type)	MAG Track ↓ / ↑	Geodesic Distance	Upper limit / lower limit	IFR cruising levels max/min		
UN873 (RNP/RNAV)				↓	↑	
▲	IPERA	202154N	0204200W			SAL ACC 128.300 MHZ 126.400 MHZ
(RNAV 10)		253 NM	UNL / FL 245	even	odd	Class A
▲	SAL / AMILCAR CABRAL VOR/DME (CVS)	164412N	0225703W			
(RNAV 10)		196 NM	UNL / FL 245	even	odd	Class A
▲	POMAT	135236N	0243548W			

---

**ENR 3.4 HELICOPTER ROUTES**

NIL

**INTENTIONALLY LEFT BLANK**



**ENR 3.5 OTHER ROUTES**

NIL

**INTENTIONALLY LEFT BLANK**

**ENR 3.6 EN-ROUTE HOLDING**

<i>HLDG ID / FIX / WPT CO-ORDINATES</i>	<i>INBD TR (MAG)</i>	<i>DIRECTION OF PTN</i>	<i>MAX IAS (KT)</i>	<i>MIN - MAX HLDG LVL FL / FT (MSL)</i>	<i>TIME / DIST OUTBND</i>	<i>CONTROLLING UNIT / FREQ</i>
<i>1</i>	<i>2</i>	<i>3</i>	<i>4</i>	<i>5</i>	<i>6</i>	<i>7</i>
CVS VOR / DME 164412.02N 0225703.06W	203 (RWY 01)	RIGHT	NIL	5000 FT	1 MIN	AMILCAR CABRAL ATS 119.700 MHZ 121.500MHZ
CVS VOR / DME 164412.02N 0225703.06W	003 (RWY 19)	LEFT	NIL	5000 FT	1 MIN	AMILCAR CABRAL ATS 119.700 MHZ 121.500MHZ
SAL NDB 164206.35N 0225655.36W	204 (RWY 01)	RIGHT	NIL	5000 FT	1 MIN	AMILCAR CABRAL ATS 119.700 MHZ 121.500MHZ

**INTENTIONALLY LEFT BLANK**

**ENR 4. RADIO NAVIGATION AIDS/SYSTEMS**

**ENR 4.1 RADIO NAVIGATION AIDS - EN-ROUTE**

<i>Name of station (VAR) (VOR: Declination)</i>	<i>ID</i>	<i>FREQ (CH)</i>	<i>Hours of operation</i>	<i>Coordinates</i>		<i>ELEV DME Antenna</i>	<i>Remarks</i>
<i>1</i>	<i>2</i>	<i>3</i>	<i>4</i>	<i>5</i>		<i>6</i>	<i>7</i>
BOA VIST / RABIL NDB (11°W)	BVT	341 KHZ	H24	160803.40N	0225317.00W	NIL	Coverage: 50 NM
PRAIA / NELSON MANDELA VOR / DME (11°W)	SNT	116.600 MHZ (CH 113X)	H24	145620.74N	0232855.64W	340 FT / 101 M	Coverage: 200 NM / FL 500
SAL / AMILCAR CABRAL VOR / DME (10°W)	CVS	115.300 MHZ (CH 100X)	H24	164412.02N	0225703.06W	196 FT / 60 M	Coverage: 200 NM / FL 500
SAO VICENTE NDB (11°W)	SVT	333 KHZ 333 KHZ	H24	164944.90N	0250352.60W	NIL	NIL

**INTENTIONALLY LEFT BLANK**

---

**ENR 4.2 SPECIAL NAVIGATION SYSTEMS**

NIL

**INTENTIONALLY LEFT BLANK**



---

**ENR 4.3 GLOBAL NAVIGATION SATELLITE SYSTEM (GNSS)**

NIL

**INTENTIONALLY LEFT BLANK**

ENR 4.4 NAME - CODE DESIGNATORS FOR SIGNIFICANT POINTS

Name-code designator	Coordinates		ATS route or other route	Remarks
1	2		3	4
AGTIL	135354N	0242034W	B623, W33, UW33	
AMDOL	142112N	0262130W	UN866	
BAMUX	231318N	0263229W		
BIKOM	154330N	0314818W		
BORTA	135514N	0204345W	W32, UW32	
BOTNO	133000N	0231430W	UN857	
BULVO	140228N	0243012W	W13, W34, UW34	
DENER	152724N	0254132W	W45, UW45	
EDIPA	160755N	0261600W	W46, UW46	
EDUMO	225454N	0233606W	UN741, UW41	
ERNEK	202542N	0314314W		
EVKAS	174803N	0260116W	W47, UW47	
GAMBA	185706N	0260342W	UN741, UR976	
GARPO	161630N	0341000W		
GUNET	193500N	0194406W	UN857, UW11	
ILGAS	184000N	0200000W		
IPERA	202154N	0204200W	B623, UN873, UW43	
IREDO	174306N	0241812W	UN866, UR976	
KENOX	144836N	0282936W	UN741, UW46	
KESIK	180928N	0245513W	W15	
LININ	180905N	0244524W	W41, UW41	
LUMPO	154048N	0200000W	R976, UR976	
MOGSA	144118N	0201241W	A602, W31, UA602, UW31	
MOPAC	180720N	0240250W	W42, UW42	
NATAS	160024N	0330000W		
NEMDO	180557N	0233154W	W43, UW43	
NINAU	164952N	0241547W		
OBOMO	224315N	0273020W		
ONOB	134136N	0242630W	B623, UB623	
ORABI	155618N	0215212W	UA602, UN857	
PINPO	173905N	0215608W	W11, W22, UW11, UW22	
PISPU	175320N	0221453W	B623, W21, UW21	
PIXED	240000N	0250000W		
POLMO	161629N	0213834W	R976	
POMAT	135236N	0243548W	UN873	
RAMOL	155142N	0214606W	A602	
RUKAV	221037N	0283217W		
SEPOM	172000N	0200000W		
SISAU	162116N	0242011W		
SONVA	145014N	0220438W	W31	
TARIM	151024N	0293230W		
TEGTO	205737N	0304617W		
TENPA	212100N	0215824W	UN866	
TUTLO	170000N	0373000W		
UGAMA	161712N	0214012W	UR976	
ULTEM	212946N	0294800W	UR976, UW47	
VEPOP	192203N	0333403W		

<i>Name-code designator</i>	<i>Coordinates</i>		<i>ATS route or other route</i>	<i>Remarks</i>
<i>1</i>	<i>2</i>		<i>3</i>	<i>4</i>
VONTO	142802N	0221134W	W32	
XIBOT	181515N	0352648W		
XIGLU	233600N	0242500W		
XUVIT	152724N	0304136W		

## ENR 4.5 AERONAUTICAL GROUND LIGHTS - EN-ROUTE

Name IDENT (Co - ordinates)	Type and Intensity (1000 Candelas)	Characteristics	Operating Hours	Remarks
1	2	3	4	5
BOA VISTA ISLAND *165954N 0224105W (Morro Negro)	Marine	FLG W EV 2 SEC	HN	NIL
BRAVA ISLAND *144754N 0255305W (Ponta Nho Martinho)	Marine	GP FLG W (4) EV 20 SEC	HN	NIL
FOGO ISLAND *144954N 0241905W (Alcatraz)	Marine	FLG W EV 5 SEC	HN	NIL
SAL ISLAND *164454N 0225705W (Amlcar Cabral)	ABN	ALT FLG G - W EV 10 SEC	HO - IMC	W 2250 G 450
SANTO ANTAO ISLAND *170654N 0245905W (Ponta De Tumba)	Marine	FLG W EV 58 SEC	HN	NIL
*170254N 0252205W (Ponta Mangrade)	Marine	GP FLG W (2) EV 10 SEC	HN	NIL
*171202N 0250512W (Ponta Do Sol)	Marine	GP FLG W EV 4 SEC	HN	W 2700
SANTIAGO ISLAND (Nelson Mandela)	ABN	ALT FLG G - W EV 5 SEC	HO - IMC	W 160.000 G 20.000
*145628N 0232905W (Ponta Moreia)	Marine	GP FLG W (6) EV 10 SEC	HN	NIL
*145354N 0233105W (Ponta Temerosa)	Marine	GP FLG W (2) EV 10 SEC	HN	NIL
SAO NICOLAU ISLAND *163554N 0242505W (Ponta Barril)	Marine	FIX W	HN	NIL
*163354N 0240105W (Ponta Lest)	Marine	GP FLG W (4) EV 10 SEC	HN	NIL
ROMBO OR SECOS ISLAND *145754N 0243905W (Grande Islet)	Marine	GP FLG W (3) EV 20 SEC	HN	NIL

**INTENTIONALLY LEFT BLANK**

**ENR 5. NAVIGATION WARNINGS**

**ENR 5.1 PROHIBITED, RESTRICTED AND DANGER AREAS**

NIL

**INTENTIONALLY LEFT BLANK**



---

**ENR 5.2 MILITARY EXERCISE AND TRAINING AREAS AND AIR DEFENCE IDENTIFICATION ZONE (ADIZ)**

NIL

**INTENTIONALLY LEFT BLANK**

**ENR 5.3 OTHER ACTIVITIES OF A DANGEROUS NATURE AND OTHER POTENTIAL HAZARDS**

NIL

**INTENTIONALLY LEFT BLANK**

ENR 5.4 AIR NAVIGATION OBSTACLES - AREA 1

(Height 100 m AGL or higher)

<i>Designation</i>	<i>OBST type</i>	<i>OBST position</i>	<i>ELEV/HGT (M)</i>	<i>OBST LGT Type/Colour</i>	<i>Remarks</i>
1	2	3	4	5	6
GVAC001	Pole	164525.4N 0225632.9W	463.08 FT/ NIL	Yes	NIL

**INTENTIONALLY LEFT BLANK**

---

**ENR 5.5 AERIAL SPORTING AND RECREATIONAL ACTIVITIES**

NIL

**INTENTIONALLY LEFT BLANK**



---

**ENR 5.6 BIRD MIGRATION AND AREAS WITH SENSITIVE FAUNA**

NIL

**INTENTIONALLY LEFT BLANK**

Removed W21, W22, W33 & W34

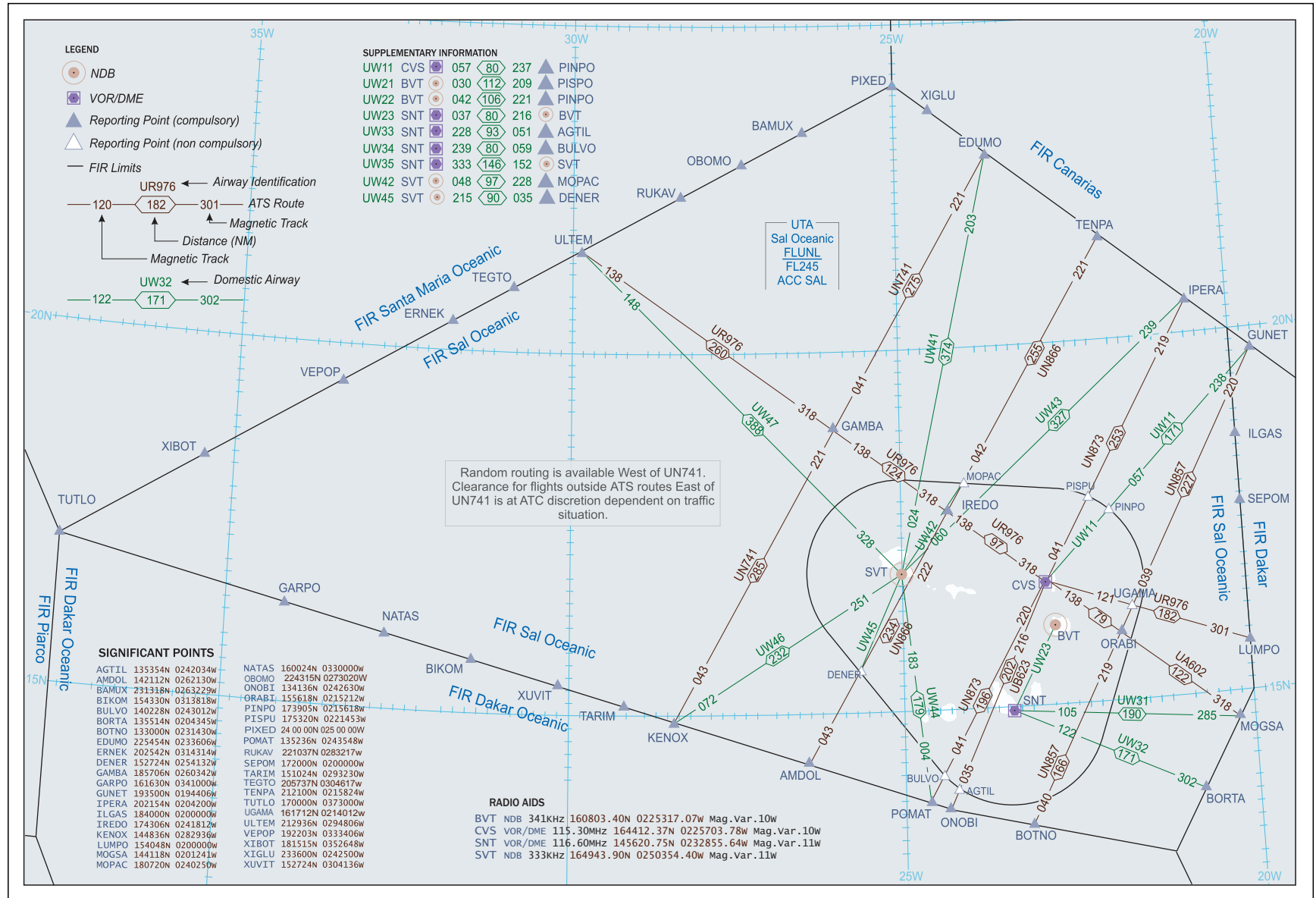

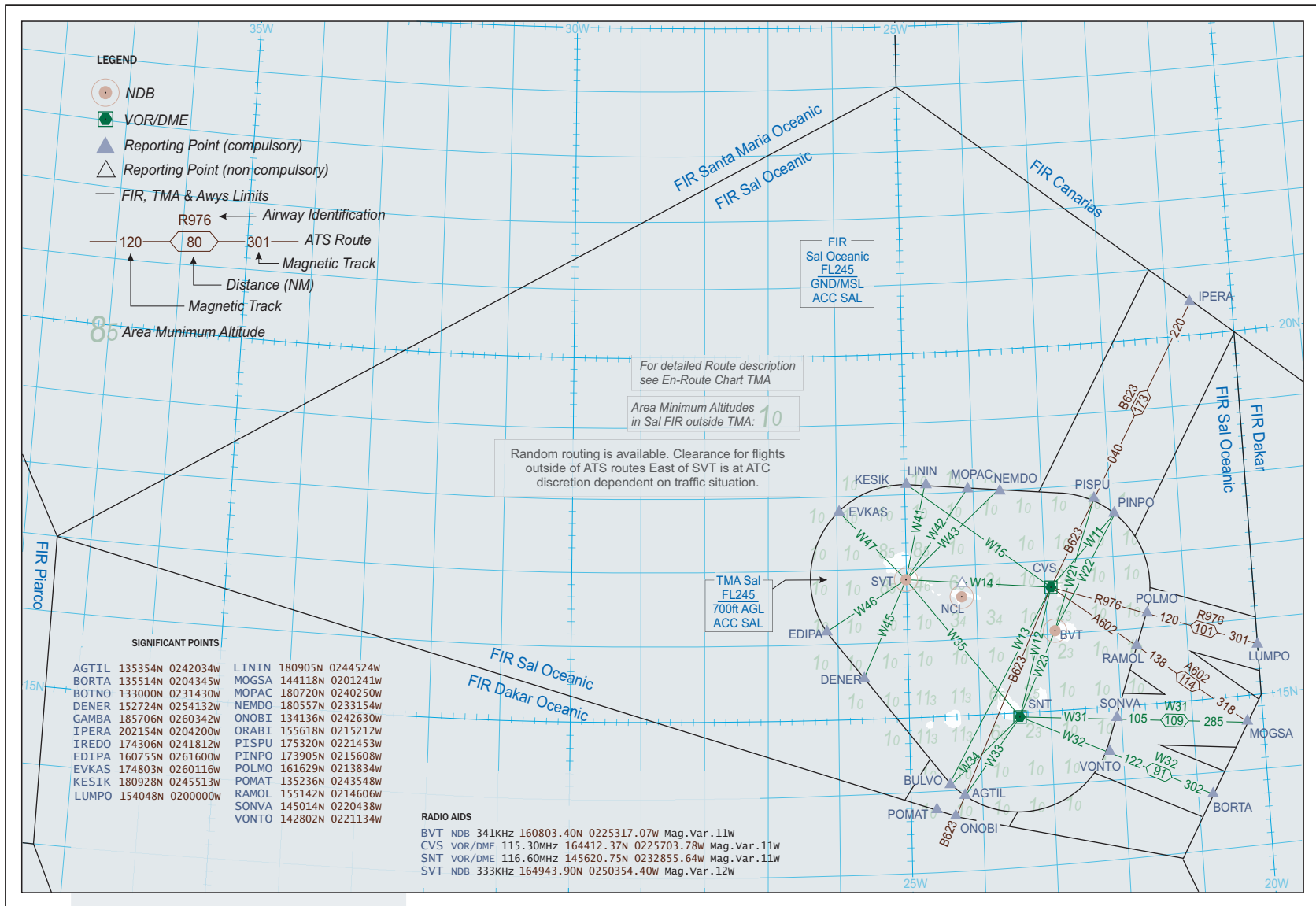

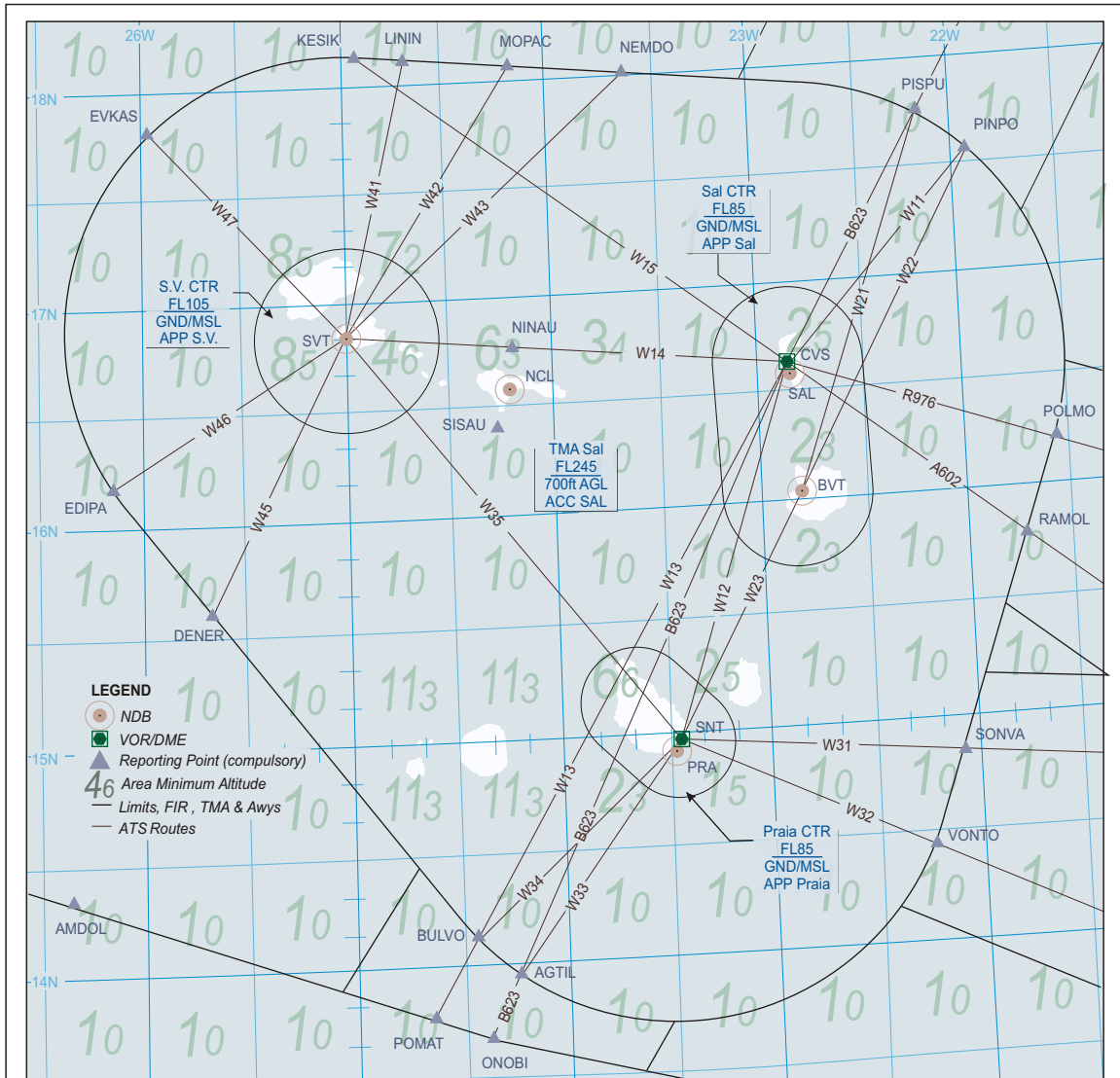

**LEGEND**  
 ● NDB  
 ▲ VOR/DME  
 ▲ Reporting Point (compulsory)  
 46 Area Minimum Altitude  
 — Limits, FIR, TMA & Aways  
 — ATS Routes

**LOWER AIRSPACE ATS ROUTES**

B623 IPERA ▲ 220 <80> 040 ▲ PISPU 220 <80> 040 ● CVS 216 <188> 037 ▲ AGTIL 217 <14> 037 ▲ ONOBI  
 A602 CVS ● 138 <86> 318 ▲ RAMOL - MOGSA  
 R976 CVS ● 121 <80> 301 ▲ POLMO - LUMPO  
 W11 CVS ● 057 <80> 237 ▲ PINPO  
 W12 CVS ● 207 <112> 027 ● SNT  
 W13 CVS ● 220 <185> 041 ▲ BULVO  
 W14 CVS ● 284 <122> 104 ● SVT  
 W15 CVS ● 318 <141> 138 ▲ KESIK  
 W21 BVT ● 030 <116> 209 ▲ PISPU  
 W22 BVT ● 042 <106> 221 ▲ PINPO  
 W23 BVT ● 216 <80> 037 ● SNT  
 W31 SNT ● 105 <82> 285 ▲ SONVA105 <109> 285 ▲ MOGSA  
 W32 SNT ● 122 <80> 302 ▲ VONTO122 <91> 302 ▲ BORTA  
 W33 SNT ● 230 <80> 051 ▲ AGTIL  
 W34 SNT ● 239 <80> 059 ▲ BULVO  
 W35 SNT ● 333 <146> 152 ● SVT  
 W41 SVT ● 024 <81> 204 ▲ LININ  
 W42 SVT ● 044 <92> 224 ▲ MOPAC  
 W43 SVT ● 060 <116> 240 ▲ NEMDO  
 W45 SVT ● 218 <88> 039 ▲ DENER  
 W46 SVT ● 251 <81> 071 ▲ EDIPA  
 W47 SVT ● 328 <80> 149 ▲ EVKAS

**SIGNIFICANT POINTS**

AGTIL 135354N 0242034W  
 AMDOL 142112N 0262130W  
 BULVO 140228N 0243012W  
 DENER 152724N 0254132W  
 EDIPA 160755N 0261600W  
 EVKAS 174803N 0260116W  
 KESIK 180928N 0245513W  
 LININ 180905N 0244524W  
 MOPAC 180720N 0240250W  
 NEMDO 180557N 0233154W  
 NINAU 164952N 0241547W  
 ONOBI 134136N 0242630W  
 PISPU 175320N 0221453W  
 PINPO 173905N 0215608W  
 POLMO 161629N 0213834W  
 POMAT 135236N 0243548W  
 RAMOL 155142N 0214606W  
 SISAU 162116N 0242011W  
 SONVA 145014N 0220438W  
 VONTO 142802N 0221134W

**RADIO AIDS**

BVT NDB 341KHz 160803.40N 0225317.07W Mag.Var.11w  
 CVS VOR/DME 115.30MHz CH100x 164412.37N 0225703.78W Mag.Var.11w  
 NCL L 357KHz 163345.86N 0241659.51W Mag.Var.12w  
 PRA NDB 349KHz 145521.34N 0232946.39W Mag.Var.11w  
 SAL NDB 274KHz 164206.42N 0225655.37W Mag.Var.11w  
 SNT VOR/DME 116.60MHz CH113x 145620.75N 0232855.64W Mag.Var.11w  
 SVT NDB 333KHz 164943.90N 0250354.40W Mag.Var.12w

**INTENTIONALLY LEFT BLANK**

**PART 3 - AERODROMES (AD)****AD 0.****AD 0.1 TABLE OF CONTENT TO PART 3**

		<i>Page</i>
<b>AD 0.</b>		
AD 0.1	TABLE OF CONTENT TO PART 3	AD 0.1-1
<b>AD 1.</b>	<b>AERODROMES / HELIPORTS - INTRODUCTION</b>	
AD 1.1	AERODROME / HELIPORT AVAILABILITY AND CONDITION OF USE	AD 1.1-1
AD 1.2	RESCUE AND FIRE FIGHTING SERVICES AND SNOW PLAN	AD 1.2-1
AD 1.3	INDEX TO AERODROMES AND HELIPORTS	AD 1.3-1
AD 1.4	GROUPING OF AERODROMES / HELIPORTS	AD 1.4-1
AD 1.5	STATUS OF CERTIFICATION OF AERODROMES	AD 1.5-1
<b>AD 2.</b>	<b>AERODROMES</b>	
	<b>GVAC - SAL ISLAND / AMILCAR CABRAL</b>	
GVAC AD 2.1	AERODROME LOCATION INDICATOR AND NAME	GVAC AD 2-1
GVAC AD 2.2	AERODROME GEOGRAPHICAL AND ADMINISTRATIVE DATA	GVAC AD 2-1
GVAC AD 2.3	OPERATIONAL HOURS	GVAC AD 2-1
GVAC AD 2.4	HANDLING SERVICES AND FACILITIES	GVAC AD 2-1
GVAC AD 2.5	PASSENGER FACILITIES	GVAC AD 2-2
GVAC AD 2.6	RESCUE AND FIRE FIGHTING SERVICES	GVAC AD 2-2
GVAC AD 2.7	SEASONAL AVAILABILITY - CLEARING	GVAC AD 2-2
GVAC AD 2.8	APRONS, TAXIWAYS AND CHECK LOCATIONS / POSITIONS DATA	GVAC AD 2-2
GVAC AD 2.9	SURFACE MOVEMENT GUIDANCE AND CONTROL SYSTEM AND MARKINGS	GVAC AD 2-3
GVAC AD 2.10	AERODROME OBSTACLES	GVAC AD 2-3
GVAC AD 2.11	METEOROLOGICAL INFORMATION PROVIDED	GVAC AD 2-3
GVAC AD 2.12	RUNWAY PHYSICAL CHARACTERISTICS	GVAC AD 2-4
GVAC AD 2.13	DECLARED DISTANCES	GVAC AD 2-4
GVAC AD 2.14	APPROACH AND RUNWAY LIGHTING	GVAC AD 2-4
GVAC AD 2.15	OTHER LIGHTING SECONDARY POWER SUPPLY	GVAC AD 2-4
GVAC AD 2.16	HELICOPTER LANDING AREA	GVAC AD 2-5
GVAC AD 2.17	ATS AIRSPACE	GVAC AD 2-5
GVAC AD 2.18	ATS COMMUNICATION FACILITIES	GVAC AD 2-5
GVAC AD 2.19	RADIO NAVIGATION AND LANDING AIDS	GVAC AD 2-5
GVAC AD 2.20	LOCAL TRAFFIC REGULATIONS	GVAC AD 2-7
GVAC AD 2.21	NOISE ABATEMENT PROCEDURES	GVAC AD 2-7
GVAC AD 2.22	FLIGHT PROCEDURES	GVAC AD 2-7
GVAC AD 2.23	ADDITIONAL INFORMATION	GVAC AD 2-8
GVAC AD 2.24	CHARTS RELATED TO AN AERODROME	GVAC AD 2-8
	<b>GVBA - RABIL / ARISTIDES PEREIRA</b>	
GVBA AD 2.1	AERODROME LOCATION INDICATOR AND NAME	GVBA AD 2-1
GVBA AD 2.2	AERODROME GEOGRAPHICAL AND ADMINISTRATIVE DATA	GVBA AD 2-1
GVBA AD 2.3	OPERATIONAL HOURS	GVBA AD 2-1
GVBA AD 2.4	HANDLING SERVICES AND FACILITIES	GVBA AD 2-2
GVBA AD 2.5	PASSENGER FACILITIES	GVBA AD 2-2
GVBA AD 2.6	RESCUE AND FIRE FIGHTING SERVICES	GVBA AD 2-2
GVBA AD 2.7	SEASONAL AVAILABILITY - CLEARING	GVBA AD 2-2
GVBA AD 2.8	APRONS, TAXIWAYS AND CHECK LOCATIONS / POSITIONS DATA	GVBA AD 2-3
GVBA AD 2.9	SURFACE MOVEMENT GUIDANCE AND CONTROL SYSTEM AND MARKINGS	GVBA AD 2-3
GVBA AD 2.10	AERODROME OBSTACLES	GVBA AD 2-3
GVBA AD 2.11	METEOROLOGICAL INFORMATION PROVIDED	GVBA AD 2-4
GVBA AD 2.12	RUNWAY PHYSICAL CHARACTERISTICS	GVBA AD 2-4
GVBA AD 2.13	DECLARED DISTANCES	GVBA AD 2-5
GVBA AD 2.14	APPROACH AND RUNWAY LIGHTING	GVBA AD 2-5
GVBA AD 2.15	OTHER LIGHTING SECONDARY POWER SUPPLY	GVBA AD 2-5
GVBA AD 2.16	HELICOPTER LANDING AREA	GVBA AD 2-5
GVBA AD 2.17	ATS AIRSPACE	GVBA AD 2-5
GVBA AD 2.18	ATS COMMUNICATION FACILITIES	GVBA AD 2-6
GVBA AD 2.19	RADIO NAVIGATION AND LANDING AIDS	GVBA AD 2-6
GVBA AD 2.20	LOCAL TRAFFIC REGULATIONS	GVBA AD 2-7
GVBA AD 2.21	NOISE ABATEMENT PROCEDURES	GVBA AD 2-7

		<i>Page</i>
GVBA AD 2.22	FLIGHT PROCEDURES	GVBA AD 2-7
GVBA AD 2.23	ADDITIONAL INFORMATION	GVBA AD 2-7
GVBA AD 2.24	CHARTS RELATED TO AN AERODROME	GVBA AD 2-8
<b>GVMA - MAIO ISLAND / MAIO</b>		
GVMA AD 2.1	AERODROME LOCATION INDICATOR AND NAME	GVMA AD 2-1
GVMA AD 2.2	AERODROME GEOGRAPHICAL AND ADMINISTRATIVE DATA	GVMA AD 2-1
GVMA AD 2.3	OPERATIONAL HOURS	GVMA AD 2-1
GVMA AD 2.4	HANDLING SERVICES AND FACILITIES	GVMA AD 2-1
GVMA AD 2.5	PASSENGER FACILITIES	GVMA AD 2-2
GVMA AD 2.6	RESCUE AND FIRE FIGHTING SERVICES	GVMA AD 2-2
GVMA AD 2.7	SEASONAL AVAILABILITY - CLEARING	GVMA AD 2-2
GVMA AD 2.8	APRONS, TAXIWAYS AND CHECK LOCATIONS / POSITIONS DATA	GVMA AD 2-2
GVMA AD 2.9	SURFACE MOVEMENT GUIDANCE AND CONTROL SYSTEM AND MARKINGS	GVMA AD 2-2
GVMA AD 2.10	AERODROME OBSTACLES	GVMA AD 2-3
GVMA AD 2.11	METEOROLOGICAL INFORMATION PROVIDED	GVMA AD 2-3
GVMA AD 2.12	RUNWAY PHYSICAL CHARACTERISTICS	GVMA AD 2-3
GVMA AD 2.13	DECLARED DISTANCES	GVMA AD 2-4
GVMA AD 2.14	APPROACH AND RUNWAY LIGHTING	GVMA AD 2-4
GVMA AD 2.15	OTHER LIGHTING SECONDARY POWER SUPPLY	GVMA AD 2-4
GVMA AD 2.16	HELICOPTER LANDING AREA	GVMA AD 2-4
GVMA AD 2.17	ATS AIRSPACE	GVMA AD 2-5
GVMA AD 2.18	ATS COMMUNICATION FACILITIES	GVMA AD 2-5
GVMA AD 2.19	RADIO NAVIGATION AND LANDING AIDS	GVMA AD 2-5
GVMA AD 2.20	LOCAL TRAFFIC REGULATIONS	GVMA AD 2-6
GVMA AD 2.21	NOISE ABATEMENT PROCEDURES	GVMA AD 2-6
GVMA AD 2.22	FLIGHT PROCEDURES	GVMA AD 2-6
GVMA AD 2.23	ADDITIONAL INFORMATION	GVMA AD 2-6
GVMA AD 2.24	CHARTS RELATED TO AN AERODROME	GVMA AD 2-6
<b>GVNP - PRAIA / NELSON MANDELA</b>		
GVNP AD 2.1	AERODROME LOCATION INDICATOR AND NAME	GVNP AD 2-1
GVNP AD 2.2	AERODROME GEOGRAPHICAL AND ADMINISTRATIVE DATA	GVNP AD 2-1
GVNP AD 2.3	OPERATIONAL HOURS	GVNP AD 2-1
GVNP AD 2.4	HANDLING SERVICES AND FACILITIES	GVNP AD 2-1
GVNP AD 2.5	PASSENGER FACILITIES	GVNP AD 2-2
GVNP AD 2.6	RESCUE AND FIRE FIGHTING SERVICES	GVNP AD 2-2
GVNP AD 2.7	SEASONAL AVAILABILITY - CLEARING	GVNP AD 2-2
GVNP AD 2.8	APRONS, TAXIWAYS AND CHECK LOCATIONS / POSITIONS DATA	GVNP AD 2-2
GVNP AD 2.9	SURFACE MOVEMENT GUIDANCE AND CONTROL SYSTEM AND MARKINGS	GVNP AD 2-3
GVNP AD 2.10	AERODROME OBSTACLES	GVNP AD 2-3
GVNP AD 2.11	METEOROLOGICAL INFORMATION PROVIDED	GVNP AD 2-3
GVNP AD 2.12	RUNWAY PHYSICAL CHARACTERISTICS	GVNP AD 2-4
GVNP AD 2.13	DECLARED DISTANCES	GVNP AD 2-4
GVNP AD 2.14	APPROACH AND RUNWAY LIGHTING	GVNP AD 2-4
GVNP AD 2.15	OTHER LIGHTING SECONDARY POWER SUPPLY	GVNP AD 2-4
GVNP AD 2.16	HELICOPTER LANDING AREA	GVNP AD 2-4
GVNP AD 2.17	ATS AIRSPACE	GVNP AD 2-5
GVNP AD 2.18	ATS COMMUNICATION FACILITIES	GVNP AD 2-5
GVNP AD 2.19	RADIO NAVIGATION AND LANDING AIDS	GVNP AD 2-5
GVNP AD 2.20	LOCAL TRAFFIC REGULATIONS	GVNP AD 2-6
GVNP AD 2.21	NOISE ABATEMENT PROCEDURES	GVNP AD 2-6
GVNP AD 2.22	FLIGHT PROCEDURES	GVNP AD 2-6
GVNP AD 2.23	ADDITIONAL INFORMATION	GVNP AD 2-6
GVNP AD 2.24	CHARTS RELATED TO AN AERODROME	GVNP AD 2-7
<b>GVSF - FOGO ISLAND / SAO FILIPE</b>		
GVSF AD 2.1	AERODROME LOCATION INDICATOR AND NAME	GVSF AD 2-1
GVSF AD 2.2	AERODROME GEOGRAPHICAL AND ADMINISTRATIVE DATA	GVSF AD 2-1
GVSF AD 2.3	OPERATIONAL HOURS	GVSF AD 2-1
GVSF AD 2.4	HANDLING SERVICES AND FACILITIES	GVSF AD 2-1
GVSF AD 2.5	PASSENGER FACILITIES	GVSF AD 2-2
GVSF AD 2.6	RESCUE AND FIRE FIGHTING SERVICES	GVSF AD 2-2
GVSF AD 2.7	SEASONAL AVAILABILITY - CLEARING	GVSF AD 2-2
GVSF AD 2.8	APRONS, TAXIWAYS AND CHECK LOCATIONS / POSITIONS DATA	GVSF AD 2-2
GVSF AD 2.9	SURFACE MOVEMENT GUIDANCE AND CONTROL SYSTEM AND MARKINGS	GVSF AD 2-2
GVSF AD 2.10	AERODROME OBSTACLES	GVSF AD 2-3
GVSF AD 2.11	METEOROLOGICAL INFORMATION PROVIDED	GVSF AD 2-3
GVSF AD 2.12	RUNWAY PHYSICAL CHARACTERISTICS	GVSF AD 2-3
GVSF AD 2.13	DECLARED DISTANCES	GVSF AD 2-4



		<i>Page</i>
GVSF AD 2.14	APPROACH AND RUNWAY LIGHTING	GVSF AD 2-4
GVSF AD 2.15	OTHER LIGHTING SECONDARY POWER SUPPLY	GVSF AD 2-4
GVSF AD 2.16	HELICOPTER LANDING AREA	GVSF AD 2-4
GVSF AD 2.17	ATS AIRSPACE	GVSF AD 2-5
GVSF AD 2.18	ATS COMMUNICATION FACILITIES	GVSF AD 2-5
GVSF AD 2.19	RADIO NAVIGATION AND LANDING AIDS	GVSF AD 2-5
GVSF AD 2.20	LOCAL TRAFFIC REGULATIONS	GVSF AD 2-6
GVSF AD 2.21	NOISE ABATEMENT PROCEDURES	GVSF AD 2-6
GVSF AD 2.22	FLIGHT PROCEDURES	GVSF AD 2-6
GVSF AD 2.23	ADDITIONAL INFORMATION	GVSF AD 2-6
GVSF AD 2.24	CHARTS RELATED TO AN AERODROME	GVSF AD 2-6
<b>GVSN - SAO NICOLAU ISLAND / PREGUICA</b>		
GVSN AD 2.1	AERODROME LOCATION INDICATOR AND NAME	GVSN AD 2-1
GVSN AD 2.2	AERODROME GEOGRAPHICAL AND ADMINISTRATIVE DATA	GVSN AD 2-1
GVSN AD 2.3	OPERATIONAL HOURS	GVSN AD 2-1
GVSN AD 2.4	HANDLING SERVICES AND FACILITIES	GVSN AD 2-1
GVSN AD 2.5	PASSENGER FACILITIES	GVSN AD 2-2
GVSN AD 2.6	RESCUE AND FIRE FIGHTING SERVICES	GVSN AD 2-2
GVSN AD 2.7	SEASONAL AVAILABILITY - CLEARING	GVSN AD 2-2
GVSN AD 2.8	APRONS, TAXIWAYS AND CHECK LOCATIONS / POSITIONS DATA	GVSN AD 2-2
GVSN AD 2.9	SURFACE MOVEMENT GUIDANCE AND CONTROL SYSTEM AND MARKINGS	GVSN AD 2-2
GVSN AD 2.10	AERODROME OBSTACLES	GVSN AD 2-3
GVSN AD 2.11	METEOROLOGICAL INFORMATION PROVIDED	GVSN AD 2-3
GVSN AD 2.12	RUNWAY PHYSICAL CHARACTERISTICS	GVSN AD 2-3
GVSN AD 2.13	DECLARED DISTANCES	GVSN AD 2-4
GVSN AD 2.14	APPROACH AND RUNWAY LIGHTING	GVSN AD 2-4
GVSN AD 2.15	OTHER LIGHTING SECONDARY POWER SUPPLY	GVSN AD 2-4
GVSN AD 2.16	HELICOPTER LANDING AREA	GVSN AD 2-4
GVSN AD 2.17	ATS AIRSPACE	GVSN AD 2-5
GVSN AD 2.18	ATS COMMUNICATION FACILITIES	GVSN AD 2-5
GVSN AD 2.19	RADIO NAVIGATION AND LANDING AIDS	GVSN AD 2-5
GVSN AD 2.20	LOCAL TRAFFIC REGULATIONS	GVSN AD 2-6
GVSN AD 2.21	NOISE ABATEMENT PROCEDURES	GVSN AD 2-6
GVSN AD 2.22	FLIGHT PROCEDURES	GVSN AD 2-6
GVSN AD 2.23	ADDITIONAL INFORMATION	GVSN AD 2-6
GVSN AD 2.24	CHARTS RELATED TO AN AERODROME	GVSN AD 2-6
<b>GVSV - SAO PEDRO / CESARIA EVORA</b>		
GVSV AD 2.1	AERODROME LOCATION INDICATOR AND NAME	GVSV AD 2-1
GVSV AD 2.2	AERODROME GEOGRAPHICAL AND ADMINISTRATIVE DATA	GVSV AD 2-1
GVSV AD 2.3	OPERATIONAL HOURS	GVSV AD 2-1
GVSV AD 2.4	HANDLING SERVICES AND FACILITIES	GVSV AD 2-2
GVSV AD 2.5	PASSENGER FACILITIES	GVSV AD 2-2
GVSV AD 2.6	RESCUE AND FIRE FIGHTING SERVICES	GVSV AD 2-2
GVSV AD 2.7	SEASONAL AVAILABILITY - CLEARING	GVSV AD 2-2
GVSV AD 2.8	APRONS, TAXIWAYS AND CHECK LOCATIONS / POSITIONS DATA	GVSV AD 2-3
GVSV AD 2.9	SURFACE MOVEMENT GUIDANCE AND CONTROL SYSTEM AND MARKINGS	GVSV AD 2-3
GVSV AD 2.10	AERODROME OBSTACLES	GVSV AD 2-3
GVSV AD 2.11	METEOROLOGICAL INFORMATION PROVIDED	GVSV AD 2-4
GVSV AD 2.12	RUNWAY PHYSICAL CHARACTERISTICS	GVSV AD 2-4
GVSV AD 2.13	DECLARED DISTANCES	GVSV AD 2-4
GVSV AD 2.14	APPROACH AND RUNWAY LIGHTING	GVSV AD 2-5
GVSV AD 2.15	OTHER LIGHTING SECONDARY POWER SUPPLY	GVSV AD 2-5
GVSV AD 2.16	HELICOPTER LANDING AREA	GVSV AD 2-5
GVSV AD 2.17	ATS AIRSPACE	GVSV AD 2-5
GVSV AD 2.18	ATS COMMUNICATION FACILITIES	GVSV AD 2-6
GVSV AD 2.19	RADIO NAVIGATION AND LANDING AIDS	GVSV AD 2-6
GVSV AD 2.20	LOCAL TRAFFIC REGULATIONS	GVSV AD 2-7
GVSV AD 2.21	NOISE ABATEMENT PROCEDURES	GVSV AD 2-7
GVSV AD 2.22	FLIGHT PROCEDURES	GVSV AD 2-7
GVSV AD 2.23	ADDITIONAL INFORMATION	GVSV AD 2-7
GVSV AD 2.24	CHARTS RELATED TO AN AERODROME	GVSV AD 2-8

**INTENTIONALLY LEFT BLANK**

## AD 1. AERODROMES / HELIPORTS - INTRODUCTION

### AD 1.1 AERODROME / HELIPORT AVAILABILITY AND CONDITION OF USE

#### 1.1.1. GENERAL CONDITIONS

##### 1.1.1.1 General conditions under which aerodromes / heliports and associated facilities are available for use

The administration of Sal Island / Amílcar Cabral, Praia / Nelson Mandela, Rabil / Aristides Pereira and Sao Pedro / Cesaria Evora is under the responsibility of ASA - Empresa Nacional de Aeroportos e Seguranca Aerea.

(See AD 2 for each aerodrome contact details)

All formalities required for customs, public health and similar procedures, will be carried out at all International Airports of Cabo Verde. The procedure will be in accordance with the provision of ICAO Annex 9 to the Convention on International Civil Aviation.

The particulars given on page **GEN 1.3.1** should, however, be specially born in mind.

##### 1.1.1.1.1 Landings made other than at an international aerodrome / heliport or a designated alternate aerodrome / heliport

1.1.1.1.1.1 If a landing is made elsewhere than at an international airport or a designated alternate airport, the pilot in command shall report the landing as soon as practicable to the health, customs and immigration authorities at the international airport at which the landing was scheduled to take place.

This notification may be made through aeronautical radio channels, if this method of communication is available, or by telegram.

1.1.1.1.1.2 The pilot in command shall responsible for ensuring that:

- a) If practice (clearance is given to an incoming aircraft by the health authority) has not been granted to the aircraft at the previous landing, contact between the other persons on the one hand the passengers and the crew on the other is avoided;
- b) That cargo, baggage and mail are not removed from the aircraft except as provided in paragraph c) below;
- c) Any foodstuffs of overseas origin, or any plant material are not removed from the aircraft except where local food is unobtainable. All food refuse, including peelings, cores, stones of fruit, etc. must be collected and return to the galley refuse container, the content of which should not be removed from the aircraft except for hygiene reasons, in which case they must be destroyed by burning or deep burial.

##### 1.1.1.1.2 Traffic of persons and vehicles on aerodromes

###### 1.1.1.1.2.1 Demarcation of zones

The grounds of each aerodrome are divided into two zones:

- a) A public zone comprising the part of the aerodrome open to the public;
- b) A restricted zone comprising of the rest of the aerodrome.

###### 1.1.1.1.2.2 Movement of persons

- a) Access to the restricted zone is authorised only under conditions prescribed by the special rules governing the aerodrome.
- b) The customs, police and health inspection offices and the premises assigned to transit traffic are normally only accessible to passengers or staff of the public authorities airlines personnel, and to authorised persons in the pursuit of their duties.

- c) The movement of persons is having access to the restricted zone of the aerodromes is subject to the conditions prescribed by the air traffic regulations and the special rules laid down by the person responsible for the management of the aerodrome.

###### 1.1.1.1.2.3 Movement of vehicles

- a) The movement of vehicles in the restricted zone is strictly limited to vehicles driven or used by persons carrying a traffic permit or an official card of admittance.
- b) Drivers of vehicles, of whatever type, driving with confines of the aerodrome, must respect the direction of the traffic, the traffic signs and the posted speed limits and generally comply with the provisions of the highway code and with instructions given by the competent authorities.

###### 1.1.1.1.3 Policing

Care and protection of aircraft, vehicles, equipment and goods for which the aerodrome facilities are used are not the responsibility of the State or any concessionaire who cannot be responsible for loss or damage which is not in-current through action by them or their agents.

###### 1.1.1.1.4 Use of the Heliports

NIL

###### 1.1.1.2 Applicable ICAO documents

The aerodrome services are provided in accordance with the provisions contained in the following ICAO documents:

- Annex 14 - Aerodrome, Volume I.

Differences to Annex 14 are detailed in subsection **GEN 1.7**.

#### 1.1.2. USE OF MILITARY AIR BASES

NIL

#### 1.1.3. LOW VISIBILITY PROCEDURES

NIL

#### 1.1.4. AERODROME OPERATING MINIMA

Friction measuring device used and friction level below which the runway is declared slippery when it is wet.

The friction characteristics of wet runways is calibrated periodically by use of MU - Meter using self - wetting features on a clean surface with 1.0 millimetres water depth at 60 KM per hour speed.

The level selected for correction maintenance action - 0.52.

Macro texture measurements: sand patch method.

Information will be provided to pilots by ATS units regarding the presence of water in runway surfaces. The information will be provided to pilots by ATS units regarding the presence of water runway surfaces. The information will be "Runway Wet" whenever water is observed to exist the runway surfaces regards of thickness of water layer.

## 1.1.5. OTHER INFORMATION

### 1.1.5.1 Runway Surface Condition Assessment

Cabo Verde's international airports use the Global Reporting Format (GRF) which comprises an assessment by airport operation staff using a Runway Condition Assessment Matrix (RCAM) and the consequent assignment of a Runway Condition Code (RWYCC) ranging from 6 to 0. This code is complemented by a description of the surface contaminant based on type, depth and % coverage for each third of the runway. The code is based on the effect of the runway conditions on aircraft braking.

The outcome of the assessment and associated RWYCC are transmitted using a Runway Condition Report (RCR) forwarded to ATS and the AIS for dissemination to pilots. The pilots will use RWYCC to determine their aircraft's performance by correlating the code with performance data provided by the aircraft's manufacturer. This will help pilots to correctly carry out their landing and take - off performance calculations for wet or contaminated runways.

The assessment process of assigning a RWYCC, starts with the identification of a contaminant, that determines the RWYCC and whether it must be reported or not. Based on all other information available, the RWYCC can be downgraded or upgraded accordingly to the GRF procedures.

The scale GOOD, GOOD TO MEDIUM, MEDIUM, MEDIUM TO POOR, POOR and LESS THAN POOR, should be used by the flight crew to characterize perceived braking action and lateral control of the aeroplane during the landing operations. When an aerodrome receives pilot reports indicating a braking action perceived as worse than that being reported, the aerodrome operator should consider reassessing the runway surface conditions. RWYCC 0 through 6 is mapped to this terminology in the RCAM and describe a consistent runway surface condition in relation to its effect on aircraft braking performance and lateral control. The RCAM correlates the RWYCC and the aircraft braking action which the flight crew should expect for each value of the RWYCC.

The aerodrome operator reports the runway surface condition on every third of the runway using a RCR. The report includes a RWYCC using the numbers 0 to 6, the contaminant's coverage and depth, and a description, which in Cabo Verde's climate can be:

- DRY
- WET
- STANDING WATER (water of depth greater than 3 millimetres)

A standard instrument will be used to measure the water on runways as part of the runway condition assessment.

By international agreement depth information is given in millimetres representing the mean of readings obtained for each third of the total runway length.

### 1.1.5.2 Runway Surface Condition Reporting

Information on aerodrome surface conditions at Cabo Verde's International Airports is available from the following sources:

- RTF between ATS and aircraft operators
- SNOWTAM.

## AD 1.2 RESCUE AND FIRE FIGHTING SERVICES AND SNOW PLAN

### 1.2.1. Rescue and fire fighting services

1.2.1.1 At aerodromes approved for scheduled and / or non-scheduled traffic with aeroplanes carrying passengers, Rescue and Fire Fighting Services and, in some cases, also Sea Rescue Services are established in accordance with the regulations for Civil Aviation.

1.2.1.2 Information about the service and what the extent of that service is, is given on the relevant page for each aerodrome.

1.2.1.3 Scheduled or non-scheduled traffic with aeroplanes carrying passengers is not allowed to use aerodromes without Rescue and Fire Fighting Services.

1.2.1.4 Each individual service is categorized according to the table shown below. Temporary changes will be published by NOTAM.

<i>Rescue and fire fighting services</i>	
<i>Aerodrome category</i>	<i>Amount of water in litres for production of performance level A foam</i>
2	670
3	1200
4	2400
5	5400
6	7900
7	12100
8	18200
9	24300
10	32300
(Category 1 is not used in the Republic of Cabo Verde)	

### 1.2.2. Snow plan

Not applicable

**INTENTIONALLY LEFT BLANK**

## AD 1.3 INDEX TO AERODROMES AND HELIPORTS

Aerodrome/heliport name Location indicator	Type of traffic permitted to use the aerodrome/heliport			Reference to AD Section and remarks
	International- National (INTL-NTL)	IFR-VFR	S = scheduled NS = Non-scheduled GA = General aviation MIL = Military O = Other	
1	2	3	4	5
<b>Aerodromes</b>				
MAIO ISLAND / MAIO GVMA*	NTL	VFR	S, NS	AD2-GVMA
PRAIA / NELSON MANDELA GVNP	INTL, NTL	IFR, VFR	S, NS, GA	AD2-GVNP
SAO NICOLAU ISLAND / PREGUICA GVSN*	NTL	VFR	S, NS	AD2-GVSN
RABIL / ARISTIDES PEREIRA GVBA	INTL, NTL	IFR, VFR	S, NS, GA	AD2-GVBA
SAL ISLAND / AMILCAR CABRAL GVAC	INTL, NTL	IFR, VFR	S, NS, GA	AD2-GVAC
FOGO ISLAND / SAO FILIPE GVSF*	NTL	VFR	S, NS	AD2-GVSF
SAO PEDRO / CESARIA EVORA GVSV	INTL, NTL	IFR, VFR	S, NS, GA	AD2-GVSV
* The location indicators marked with an asterisk (*) cannot be used in the address component of AFS messages.				

**AERODROME AND HELIPORTS - INDEX CHART**

To be developed.



---

## AD 1.4 GROUPING OF AERODROMES / HELIPORTS

### 1.4.1. General

Civil aviation aerodromes in the Republic of Cabo Verde are grouped as international and national.

### 1.4.2. International Aerodromes

The aerodrome of entry and departure for international air traffic, where all formalities concerning customs, immigration, health, animal and plant quarantine and similar procedures are carried out and where air traffic services are available on a regular basis.

### 1.4.3. National Aerodromes

An aerodrome available only for domestic air traffic.

**INTENTIONALLY LEFT BLANK**

**AD 1.5 STATUS OF CERTIFICATION OF AERODROMES**

Aerodrome name Location indicator	Date of certification	Validity of certification	Remark
1	2	3	4
Sal Island / Amilcar Cabral - GVAC	2019-09-30	2024-09-30	Certified by AAC
Sao Pedro / Cesaria Evora - GVSV	2020-11-13	2025-11-12	Certified by AAC
Praia / Nelson Mandela - GVNP	2020-12-31	2021-12-30	Certified by AAC
Rabil / Aristides Pereira - GVBA	2020-12-01	2021-08-30	Certified by AAC

**INTENTIONALLY LEFT BLANK**

## AD 2. AERODROMES

## GVAC AD 2.1 AERODROME LOCATION INDICATOR AND NAME

GVAC - SAL ISLAND / AMILCAR CABRAL

## GVAC AD 2.2 AERODROME GEOGRAPHICAL AND ADMINISTRATIVE DATA

1	ARP coordinates and site at AD	164415.32N 0225700.06W NIL
2	Direction and distance from city	3 KM S of Espargos
3	Elevation / Reference temperature / Mean low temperature	56 M (184 FT) / 27.4° C / NIL
4	Geoid Undulation at AD ELEV PSN	28.97 M (95.04 FT)
5	MAG VAR / Date of information / Annual change	10°W (2013) / 0.12° decreasing
6	AD operator, address, telephone, telefax, e-mail, AFS, website	ASA - Empresa Nacional de Aeroportos e Seguranca Aerea - S.A. Aeroporto Amilcar Cabral Espargos Sal Island Republic of Cabo Verde TEL: +238 2411135 +238 2411372 Telefax: NIL e-mail: NIL AFS: GVACYGDG Http: NIL
7	Types of traffic permitted (IFR/VFR)	IFR / VFR
8	Remarks	NIL

## GVAC AD 2.3 OPERATIONAL HOURS

1	AD operator	H 24
2	Customs and immigration	H 24
3	Health and sanitation	H 24
4	AIS Briefing office	H 24
5	ATS Reporting office (ARO)	H 24
6	MET Briefing office	H 24
7	ATS	H 24
8	Fuelling	H 24
9	Handling	H 24
10	Security	H 24
11	De-icing	NIL
12	Remarks	NIL

## GVAC AD 2.4 HANDLING SERVICES AND FACILITIES

1	Cargo handling facilities	Fork lift, high lift loader onveyer belts, vehicles and equipment air starter Tkma TM 20 D ton, ambulift MAX 900 KG capacity for 6 wheelchairs.
2	Fuel / oil types	Jet A1 / NIL
3	Fuelling facilities / capacity	Fixed hydrant system for Jet A 1 delivery rate 2270 L per MIN

4	<i>De-icing facilities</i>	NIL
5	<i>Hangar space for visiting aircraft</i>	NIL
6	<i>Repair facilities for visiting aircraft</i>	Minor repairs
7	<i>Remarks</i>	NIL

#### GVAC AD 2.5 PASSENGER FACILITIES

1	<i>Hotel(s)</i>	In cities of Espargos and Santa Maria
2	<i>Restaurant(s)</i>	At AD and in the cities
3	<i>Transportation</i>	Taxies, buses and car rental
4	<i>Medical facilities</i>	First aid, nurses, ambulances at AD Hospitals in the cities
5	<i>Bank and Post office</i>	At AD and in the cities
6	<i>Tourist office</i>	At AD and in the cities
7	<i>Remarks</i>	NIL

#### GVAC AD 2.6 RESCUE AND FIRE FIGHTING SERVICES

1	<i>AD category for fire fighting</i>	CAT 9
2	<i>Rescue equipment</i>	As per ICAO Annex 14
3	<i>Capability for removal of disabled aircraft</i>	All operators are required to put in place appropriate agreements for the supply of equipment for the removal of disabled aircraft at the airport movement area or at its proximity and to ensure its use when required. Operators are also required to submit such agreements for airport administration appraisal and recording.
4	<i>Remarks</i>	NIL

#### GVAC AD 2.7 SEASONAL AVAILABILITY - CLEARING

1	<i>Type(s) of clearing equipment</i>	NIL
2	<i>Clearance priorities</i>	NIL
3	<i>Remarks</i>	NIL

#### GVAC AD 2.8 APRONS, TAXIWAYS AND CHECK LOCATIONS / POSITIONS DATA

1	<i>Apron designation, surface and strength</i>	Designation: APRON Surface: Asphalt Strength: PCN 58 F / A / W / U
2	<i>Taxiway designation, width, surface and strength</i>	Designation: TWY Width: 23 M Surface: Asphalt Strength: PCN 58 F / A / W / U
3	<i>Altimeter checkpoint location and elevation</i>	Holding point RWY 01: 56.187 M (184.341 FT) APRON: 55.781 M (183.0 FT)
4	<i>VOR checkpoints</i>	164326.66N 0225651.81W
5	<i>INS checkpoints</i>	Holding point RWY 01: 56.187 M (184.341 FT)
6	<i>Remarks</i>	NIL

**GVAC AD 2.9 SURFACE MOVEMENT GUIDANCE AND CONTROL SYSTEM AND MARKINGS**

1	Use of aircraft stand ID signs, TWY guide lines and visual docking / parking guidance system at aircraft stands	Taxiing guidance signs at all intersections with TWY and RWY at all holding positions. Guidelines at APRON. Nose - in guidance at aircraft stands.
2	<i>RWY and TWY markings and lights</i>	RWY: Designation, THR, TDZ, CL, edge TWY: CL marked and green lights. Edge, curves, and apron exit blue lights
3	Stop bars and RWY guard lights	Stop bars: TWY A1 and A4 RWY guard lights: NIL
4	<i>Other RWY protection measures</i>	NIL
5	<i>Remarks</i>	NIL

**GVAC AD 2.10 AERODROME OBSTACLES**

<i>In Area 2</i>						
<i>OBST ID / Designation</i>	<i>OBST type</i>	<i>OBST position</i>		<i>ELEV / HGT</i>	<i>Markings / Type / Colour of lighting</i>	<i>Remarks</i>
<i>a</i>	<i>b</i>	<i>c</i>		<i>d</i>	<i>e</i>	<i>f</i>
GVAC001	Mast	164525.4N	0225632.9W	463.08 FT / NIL	red and white / NIL / LGT	NIL

<i>In Area 3</i>						
<i>OBST ID / Designation</i>	<i>OBST type</i>	<i>OBST position</i>		<i>ELEV / HGT</i>	<i>Markings / Type / Colour of lighting</i>	<i>Remarks</i>
<i>a</i>	<i>b</i>	<i>c</i>		<i>d</i>	<i>e</i>	<i>f</i>
NIL	NIL	NIL		NIL	NIL	NIL

To be developed.

**GVAC AD 2.11 METEOROLOGICAL INFORMATION PROVIDED**

1	<i>Associated MET office</i>	Sal Island / Amilcar Cabral MET Office
2	<i>Hours of service</i> <i>MET office outside hours</i>	H 24 NIL
3	<i>Office responsible for TAF preparation</i> <i>Periods of validity</i> <i>Interval of issuance</i>	Analysis and weather forecast centre GVACYMYX 0024 / 0606 / 1212 / 1818 HR NIL
4	<i>Availability of TREND forecast</i> <i>Interval of issuance</i>	Trend on request NIL
5	<i>Briefing / Consultation provided</i>	Personal consultation for flight crew members
6	<i>Flight documentation</i> <i>Language(s) used</i>	Charts, abbreviated PL text English, Portuguese, French
7	Charts and other information displayed or available for briefing or consultation	S, P, U, W; FL 180 / 300 / 390
8	Supplementary equipment available for providing information	Telefax, Satellite pictures on display. MDD Station (Meteorological Data Distribution), Aviation weather report broadcast on 127.600 MHZ
9	<i>ATS units provided with information</i>	AMILCAR CABRAL ATS, SAL APP, SAL ACC
10	<i>Additional information (Limitation of service, etc.)</i>	NIL

**GVAC AD 2.12 RUNWAY PHYSICAL CHARACTERISTICS**

Designations RWY NR	True BRG	Dimensions of RWY(M)	Strength (PCN) and surface of RWY and SWY	THR coordinates RWY end coordinates THR geoid undulation	THR elevation and highest elevation of TDZ of precision APP RWY
1	2	3	4	5	6
01	359.6°	3000 X 45	PCN 58 F / A / W / U Asphalt	164326.23N 0225655.92W 164326.17N 0225655.91W 95.04 FT	56.19 M / 184.34 FT 56.38 M / 184.97 FT
19	179.6°	3000 X 45	PCN 58 F / A / W / U Asphalt	164503.83N 0225656.60W NIL 95.04 FT	53.50 M / 175.51 FT 54.17 M / 177.71 FT

Slope of RWY-SWY	SWY dimensions (M)	CWY dimensions (M)	Strip dimensions (M)	RWY end safety area (M)	Location / description of arresting system	OFZ	Remarks
7	8	9	10	11	12	13	14
0.05 %	NIL	300 X 150	3120 X 300	210 X 210	NIL	Yes	NIL
0.05 %	NIL	300 X 150	3120 X 300	100 X 90	NIL	Yes	NIL

**GVAC AD 2.13 DECLARED DISTANCES**

RWY Designator	TORA (M)	TODA (M)	ASDA (M)	LDA (M)	Remarks
1	2	3	4	5	6
01	3000	3300	3000	3000	NIL
19	3000	3300	3000	3000	NIL

**GVAC AD 2.14 APPROACH AND RUNWAY LIGHTING**

RWY Designator	APCH LGT type LEN INTST	THR LGT colour WBAR	VASIS (MEHT) PAPI	TDZ LGT LEN	RWY CL LGT LEN, spacing, colour, INTST	RWY edge LGT LEN, spacing, colour INTST	RWY end LGT colour WBAR	SWY LGT LEN colour	Remarks
1	2	3	4	5	6	7	8	9	10
01	CAT1 720 M Intensity variable	green NIL	PAPI 3° (49.56 FT)	white 900 M	3000 M, 15 M, first 2100 M white, 600 M alt red and white, last 300 M red (intensity varia- ble)	3000 M, 30 M, 2400 M white, last 600 M yellow	red NIL	NIL	NIL
19	CAT1 900 M Intensity variable	green NIL	PAPI 3° (50.7 FT)	white 900 M	3000 M, 15 M, first 2100 M white, 600 M alt red and white, last 300 M red (intensity varia- ble)	3000 M, 30 M, 2400 M white, last 600 M yellow	red NIL	NIL	NIL

**GVAC AD 2.15 OTHER LIGHTING SECONDARY POWER SUPPLY**

1	ABN / IBN location, characteristics and hours of operation	At tower building ALT FLG G - W EV 10 SEC W 2250 G 450 HO - IMC
2	LDI / Anemometer location and LGT	Lighted / Anemometer Cup RWY 01 and RWY 19
3	TWY edge and CL lighting	Edge: On TWY Curves CL: All TWYs



4	Secondary power supply / switch - over time	SPS to all lighting at AD According to Standards
5	Remarks	NIL

**GVAC AD 2.16 HELICOPTER LANDING AREA**

1	Coordinates TLOF or THR of FATO Geoid undulation	NIL
2	TLOF and / or FATO elevation M / FT	NIL
3	TLOF and FATO area dimensions, surface, strength, marking	NIL
4	True BRG of FATO	NIL
5	Declared distance available	NIL
6	APP and FATO lighting	NIL
7	Remarks	NIL

**GVAC AD 2.17 ATS AIRSPACE**

1	Designation and lateral limits	SAL CTR Area delimited by two arcs of circle 20 NM centred on 164415.32N 0225700.06W Sal Island / Amilcar Cabral (ARP) and 160814N 0225319W Rabil / Aristides Pereira (ARP)
2	Vertical limits	GND / MSL - FL 85
3	Airspace classification	Class C
4	ATS unit call sign Language(s)	SAL APPROACH, AMILCABRAL TOWER English, Portuguese
5	Transition altitude	7000 FT
6	Hours of applicability	H 24
7	Remarks	NIL

**GVAC AD 2.18 ATS COMMUNICATION FACILITIES**

Service designation	Call sign	Channel(s)	SATVOICE number(s)	Logon address	Hours of operation	Remarks
1	2	3	4	5	6	7
ACC & RADAR	SAL CONTROL	126.400 MHZ 128.300 MHZ 127.100MHZ	NIL	NIL	H 24 H 24 H 24	TMA Sector North Sector South Sector
A / G	SAL RADIO	3452 KHZ 6535 KHZ 8661 KHZ 13357 KHZ 17955 KHZ 2854 KHZ 5565 KHZ 11291 KHZ	NIL	NIL	H 24 H 24 H 24 H 24 H 24 H 24 H 24 H 24	AFI - 1 / SAT - 1 SAT - 1 / AFI - 1 SAT - 1 / AFI - 1 SAT - 1 / AFI - 1 SAT - 1 / SAT - 2 / AFI - 1 SAT - 2 SAT - 2 SAT - 2
APP & RADAR	SAL APPROACH	126.400 MHZ 121.500 MHZ	NIL	NIL	H 24 H 24	Emergency
TWR	AMILCABRAL TOWER	119.700 MHZ 121.500 MHZ	NIL	NIL	H 24 H 24	Emergency

**GVAC AD 2.19 RADIO NAVIGATION AND LANDING AIDS**

Type of aid, MAG VAR Type of supported OPS (For VOR / ILS give declination)	ID	Frequency(ies) Channel number(s) service provider RPI	Hours of operation	Position of transmitting antenna coordinates	Elevation of the transmitting antenna of DME, GBAS reference point	Service volume radius from GBAS reference point	Remarks
1	2	3	4	5	6	7	8
VOR / DME (10°W)	CVS	115.300 MHZ 100X	H 24 H 24	164412.02N 0225703.06W	NIL 60 M (196 FT)	NIL	Coverage: 200 NM / FL 500
NDB	SAL	274 KHZ	H 24	164206.35N 0225655.36W	NIL	NIL	Coverage: 350 NM
ILS LOC RWY 01 (10°W)	SL	109.900 MHZ	H 24	164513.98N 0225656.67W	NIL	NIL	CAT 1: MM 0.57 NM OM 4.27 NM from THR 01
ILS GP RWY 01		338.8 KHZ	H 24	164336.41N 0225651.94W	NIL	NIL	Angle: 3°
ILS MM		75 KHZ	H 24	164251.96N 0225655.66W	NIL	NIL	Hight of point reference 38.9 M (127.7 FT)
ILS OM		75 KHZ	H 24	163911.45N 0225653.55W	NIL	NIL	Hight of point reference 12.6 M (41.6 FT)

## GVAC AD 2.20 LOCAL TRAFFIC REGULATIONS

### 1. Aerodrome regulations

Night - Stop parking are located on stands 01, 07 and TWY A2, thereof, the use of TWY A2 by aircraft require prior coordination and TWR authorization.

### 2. Taxiing to and from stands

Arriving aircraft will be allocated a stand number by the SMC and will always be guided by the marshaller's assistance.

### 3. Parking area for small aircraft (general aviation)

General Aviation aircraft shall be guided by marshallsers to the parking area for small aircraft.

### 4. Parking area for helicopters

NIL

### 5. Apron - Taxiing during winter conditions

NIL

### 6. Taxiing - Limitations

NIL

### 7. School and training flights - Technical test flights - Use of runways

NIL

### 8. Helicopter traffic - Limitations

NIL

### 9. Removal of disabled aircraft from runways

When an aircraft is wrecked on a runway, it is the duty of the owner or user of such aircraft to have it removed as soon as possible. If a wrecked aircraft is not removed from the runway as quickly as possible by the owner or user, the aircraft will be removed by the aerodrome authority at the owner's expenses.

### 10. Nose - In parking

Nose - In parking in use on stands 01 - 07 included. Stands 01 and 07 will also be used for parallel parking. Pilots will be guided by marshallsers.

## GVAC AD 2.21 NOISE ABATEMENT PROCEDURES

NIL

## GVAC AD 2.22 FLIGHT PROCEDURES

### 1. General

#### 1.1 Radar Vectoring Area

NIL

#### 1.2 Minimum Sector Altitude (MSA):

Three sectors within a circle of 20 NM centred on VOR / DME CVS:

- NE sector between R360 and R090 - 2700 FT
- South sector between R090 and R270 - 1700 FT
- NW sector between R270 and R360 - 2000 FT

### 2. Procedures for IFR flights within SAL CTR

The inbound, transit and outbound routes shown on the charts may be varied at the discretion of ATS if necessary. In case of congestion, inbound aircraft may also be instructed to hold at one of the designated airways reporting points. All arriving traffic destined for GVAC and GVBA aerodromes shall be at MAX IAS 250 KTS from 30 DME CVS.

### 3. Radar procedures within SAL CTR

#### 3.1 Radar vectoring and sequencing:

Radar service is available for vectoring and sequencing aircraft (see GEN 1.5.3.1 and GEN 1.5.3.2).

Normally, aircraft will be vectored and sequenced from any point of a STAR procedure to the appropriate final approach track, so as to ensure an expeditious flow of traffic. Radar vectors and flight levels / altitudes will be issued, as required, for spacing, and separation of aircraft, so that correct landing intervals are maintained, taking into account aircraft characteristics.

Within SAL TMA radar vectoring will be provided only at or above 1700 FT. Below that altitude only radar monitoring of air traffic will be provided.

*Note: Details for the provision of radar services are described in ENR 1.6.*

#### 3.2 Surveillance radar approaches:

Radar service is available for surveillance radar approaches (see GEN 1.5.3.1 and GEN 1.5.3.2)

#### 3.3 Precision radar approach

NIL

#### 3.4 Communication failure

In the event of communication failure, the pilot shall act in accordance with communication failure procedures in ICAO Annex 2. For the SAL TMA, information concerning the associated navigation aids and the routing is given in ENR 4.1.1.

### 4. Procedures for VFR flights within SAL CTR

Provided traffic conditions so permit, ATC clearance for VFR flights will be given under the conditions described below:

- a) A flight plan requesting ATC clearance, containing items 7 to 18 and indicating the purpose of the flight, shall be submitted.
- b) ATC clearance shall be obtained immediately before the aircraft enters the area concerned.
- c) Position reports shall be submitted in accordance with ICAO Annex 2 paragraph 3.6.3.
- d) Deviation from the ATC clearance may only be made when prior permission has been obtained.

- e) Two-way radio communication shall be maintained on the frequency prescribed. Information about the appropriate frequency can be obtained from Sal Information.

### GVAC AD 2.23 ADDITIONAL INFORMATION

In accordance with Cape Verde aeronautical code for slot regulation have changed from level 2 to level 3 scheduling coordinated airports by degree law 10 / 2016, of February 22, with effect from winter

2017. Request for slots shall be filled in standard IATA format (standard schedules information manual, chapter 6, and worldwide scheduling guidelines) to [slot.coordination@asa.cv](mailto:slot.coordination@asa.cv).

### GVAC AD 2.24 CHARTS RELATED TO AN AERODROME

<i>Chart name</i>	<i>Page</i>
AERODROME CHART - ICAO	GVAC AD 2-9
AIRCRAFT PARKING / DOCKING CHART - ICAO	GVAC AD 2-10
AERODROME GROUND MOVEMENT CHART - ICAO	GVAC AD 2-11
AERODROME OBSTACLE CHART RWY 01 / 19 - ICAO TYPE A	GVAC AD 2-12
STANDARD DEPARTURE CHART - INSTRUMENT (SID) RNAV RWY 01 - ICAO	GVAC AD 2-13
EN-ROUTE CHART - SAL FIR AREA MINIMUM ALTITUDES AND SAL TMA MINIMUM SECTOR ALTITUDES	GVAC AD 2-14
STANDARD DEPARTURE CHART - INSTRUMENT (SID) RNAV RWY 01 (VERSO) - ICAO	GVAC AD 2-15
STANDARD DEPARTURE CHART - INSTRUMENT (SID) RNAV RWY 19 - ICAO	GVAC AD 2-16
STANDARD ARRIVAL CHART - INSTRUMENT (STAR) RNAV RWY 01 / 19 - ICAO	GVAC AD 2-17
INSTRUMENT APPROACH CHART VOR / ILS RWY 01 CAT A - D - ICAO	GVAC AD 2-18
INSTRUMENT APPROACH CHART VOR / DME RWY 01 CAT A - D - ICAO	GVAC AD 2-19
INSTRUMENT APPROACH CHART NDB / ILS RWY 01 CAT A - D - ICAO	GVAC AD 2-20
INSTRUMENT APPROACH CHART NDB RWY 01 CAT A - D - ICAO	GVAC AD 2-21
INSTRUMENT APPROACH CHART VOR / DME RWY 19 CAT A - D - ICAO	GVAC AD 2-22

**AERODROME  
CHART-ICAO**

**16 44 15.32N  
022 57 00.06W**

**ELEV-184 ft**

**TWR-119.7**

**SAL/AMILCAR CABRAL  
INTERNATIONAL AIRPORT**

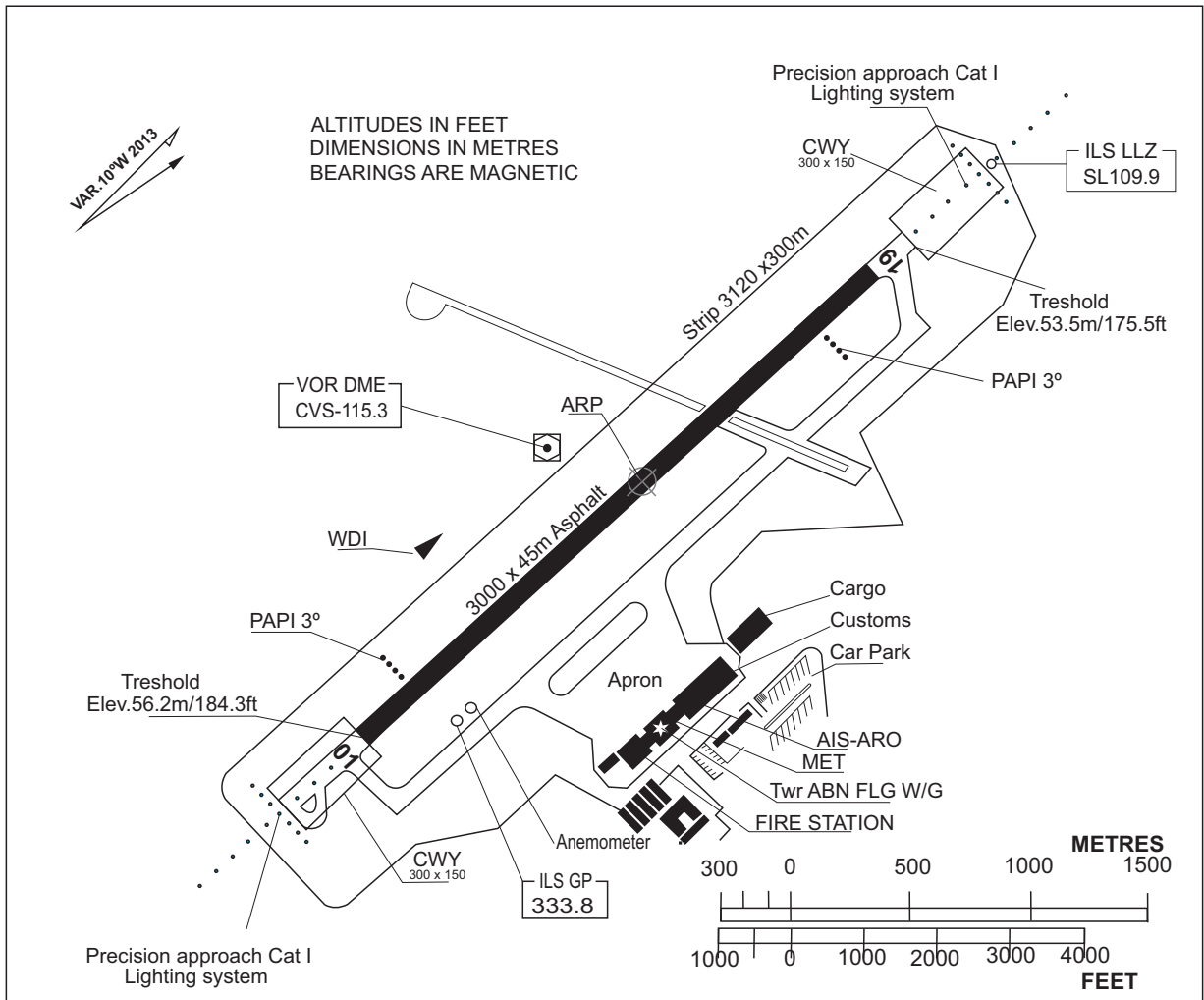

MARKING AIDS RWY 01/19 AND EXIT TWY

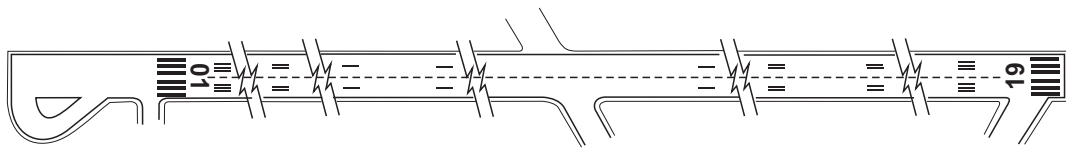

LIGHTING AIDS RWY 01/19 AND EXIT TWY

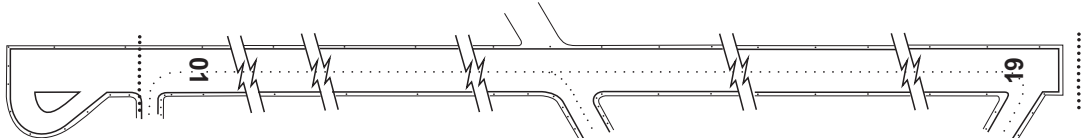

RWY	DIRECTION	THERSHOLD	BEARING STRENGTH	LIGHTING				
				RWY	PAPI	APPROACH	THRESHOLD	RUNWAY
01	359.6°GEO 10°MAG	16°43'26.23"N 022°56'55.92"W	PCN 58/F/A/W/U	01	03°	CAT I	Green	RCL,EDGE,TDZ,END
19	179.6°GEO 190°MAG	16°45'03.83"N 022°56'56.60"W		19	03°	CAT I	Green	RCL,EDGE,TDZ,END
HELIPORT				OTHER:Tawiays: Center line Green, Edge Blue				

**AIRCRAFT PARKING / DOCKING  
CHART-ICAO**

TWR 119.7  
APRON ELEV. 56m / 184 Ft

**AEROPORTO INTERNACIONAL  
AMILCAR CABRAL-SAL**

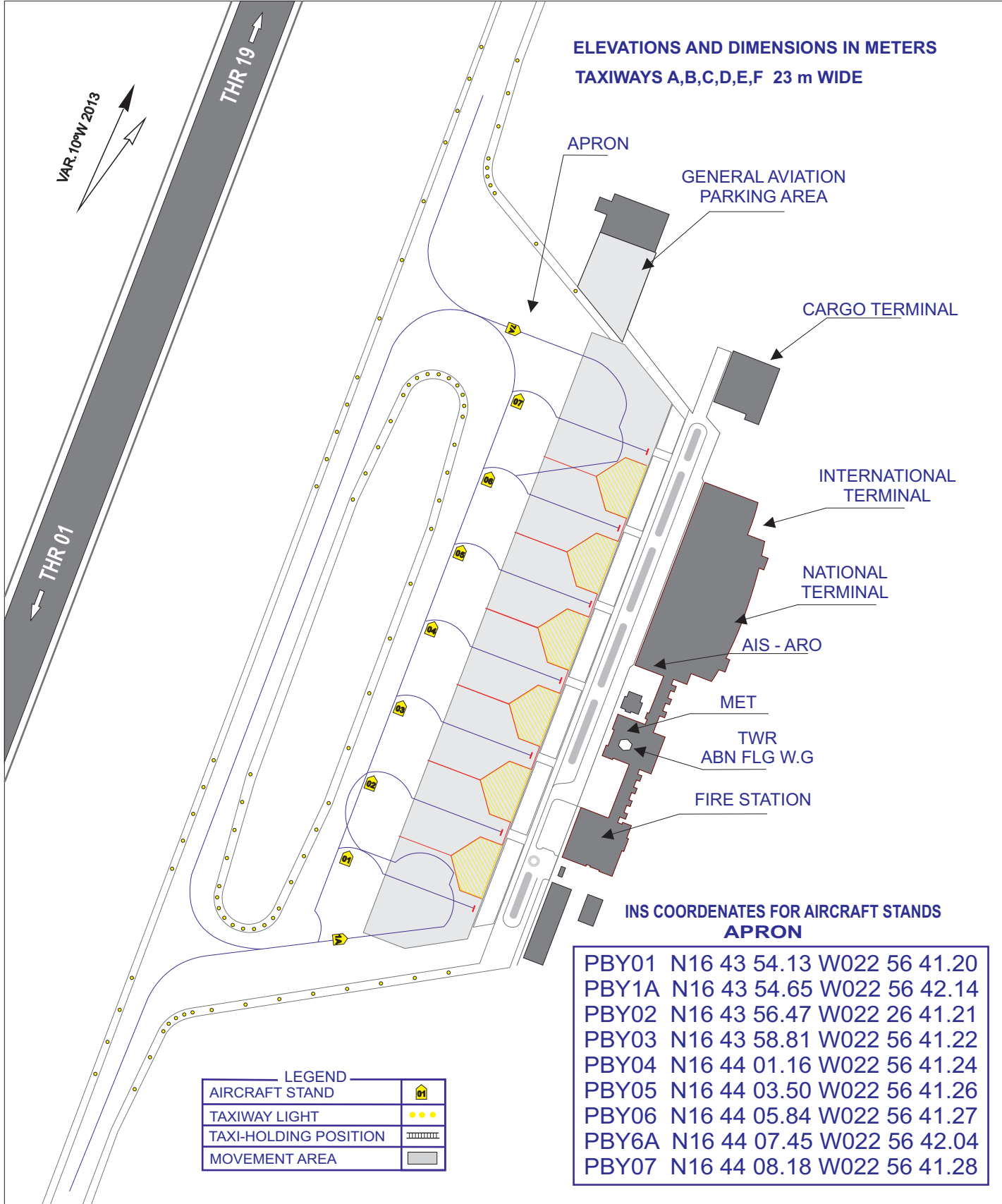

**AERODROME GROUND  
MOVEMENT CHART-ICAO**

ELEV-184ft

TWR-119.7

**SAL-AMILCAR CABRAL  
INTERNATIONAL AIRPORT**

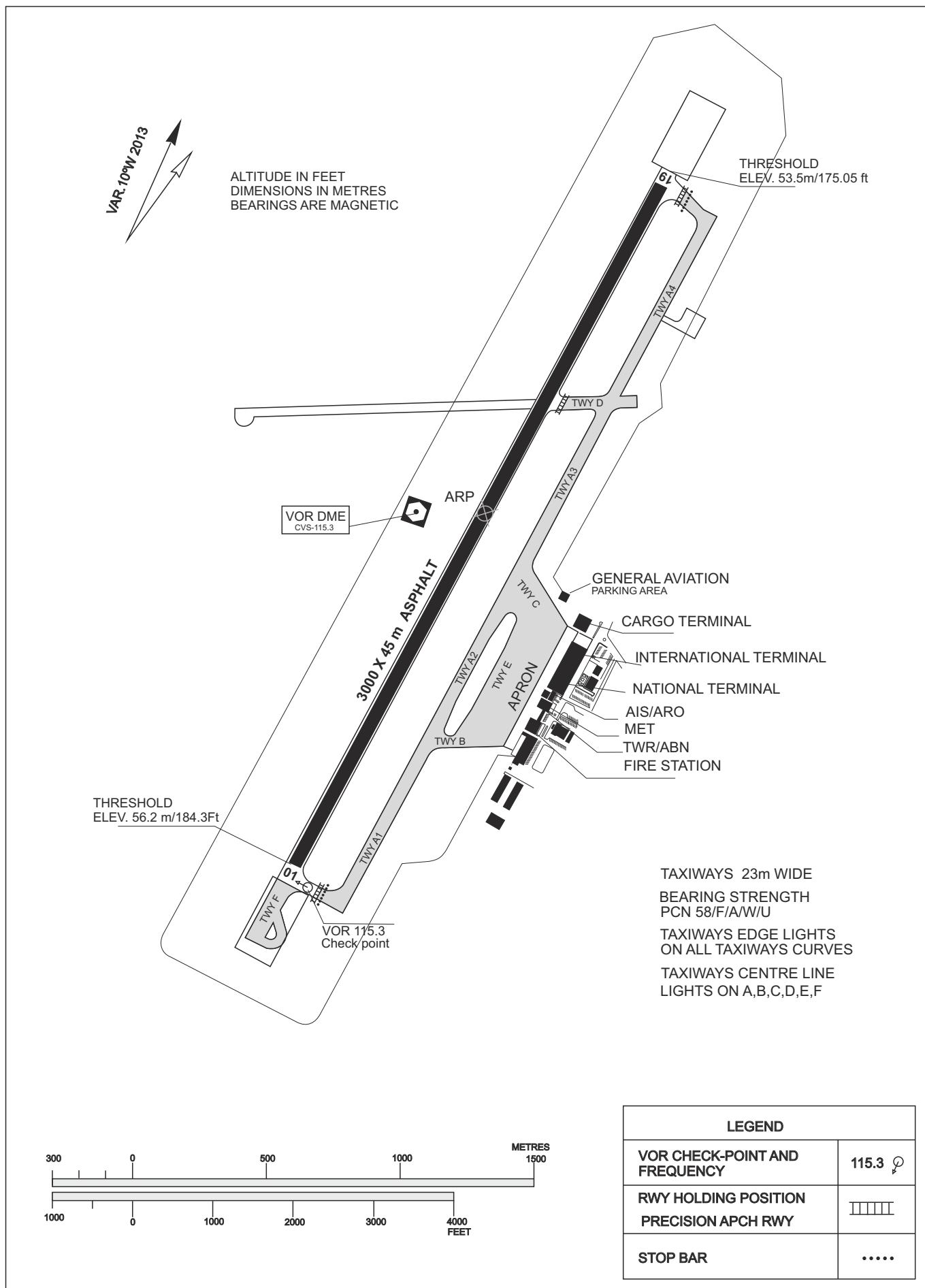

TYPE A CHART (OPERATING LIMITATIONS)

AMILCAR CABRAL AIRPORT-GVAC

RWY 01-19

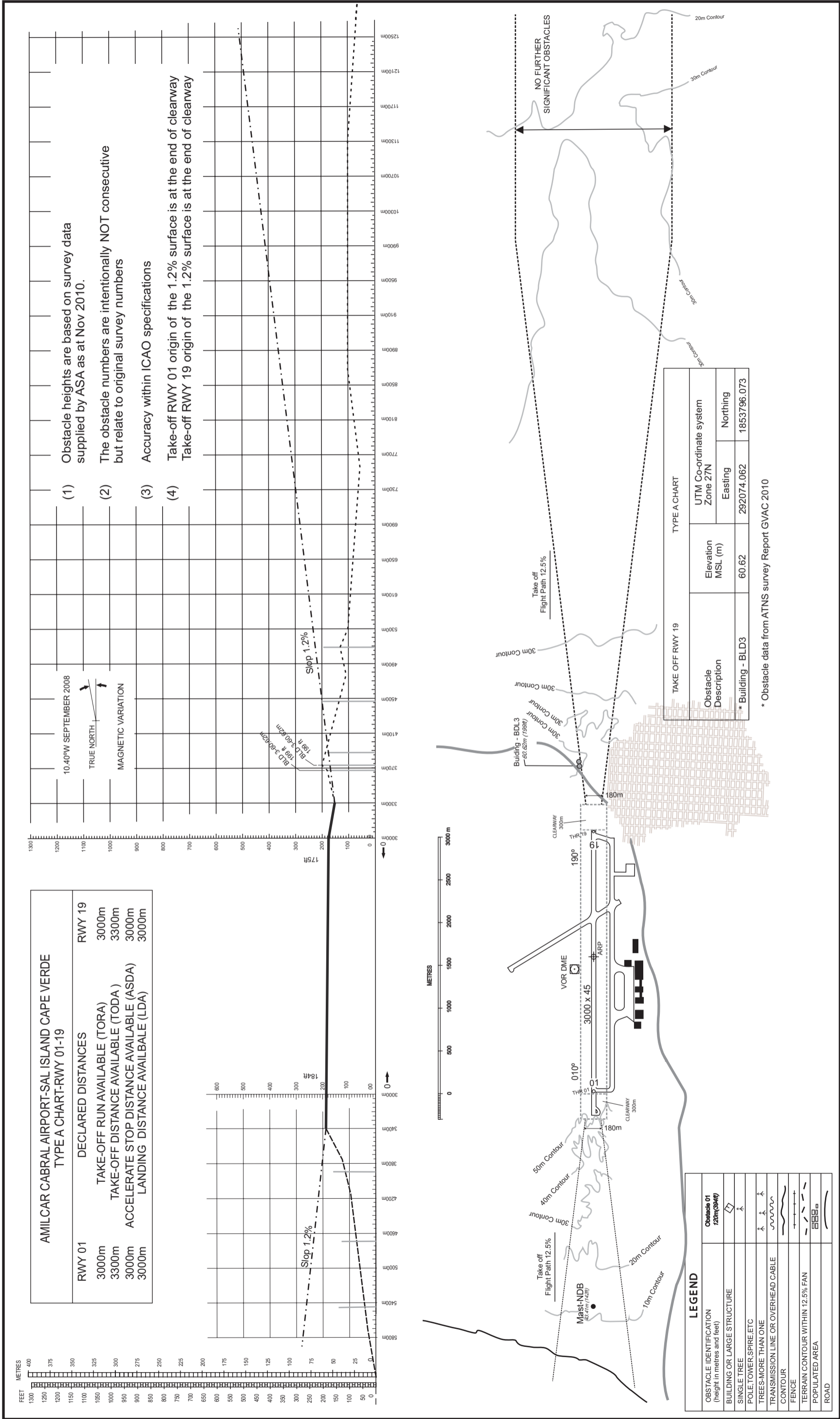



**STANDARD DEPARTURE  
CHART INSTRUMENT  
(SID) - ICAO**

**AMILCAR CABRAL  
AIRPORT GVAC  
RWY 01**

TA: 7000'  
VAR: 10W

APP - 126.400  
TWR - 119.700

TA: 7000'  
VAR: 10W

APP - 126.400  
TWR - 118.900

**RABIL AIRPORT  
GVBA  
RWY 03**

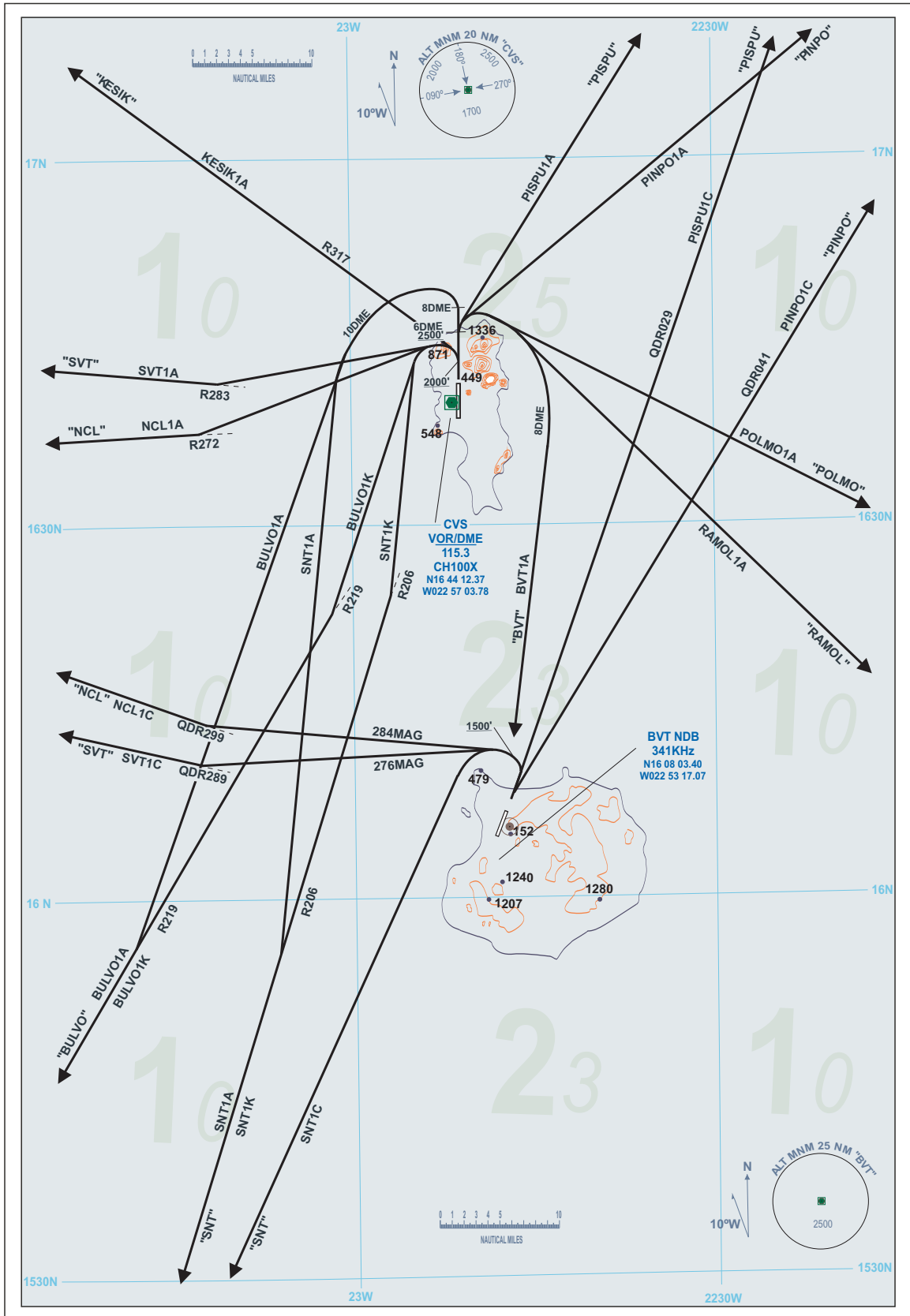

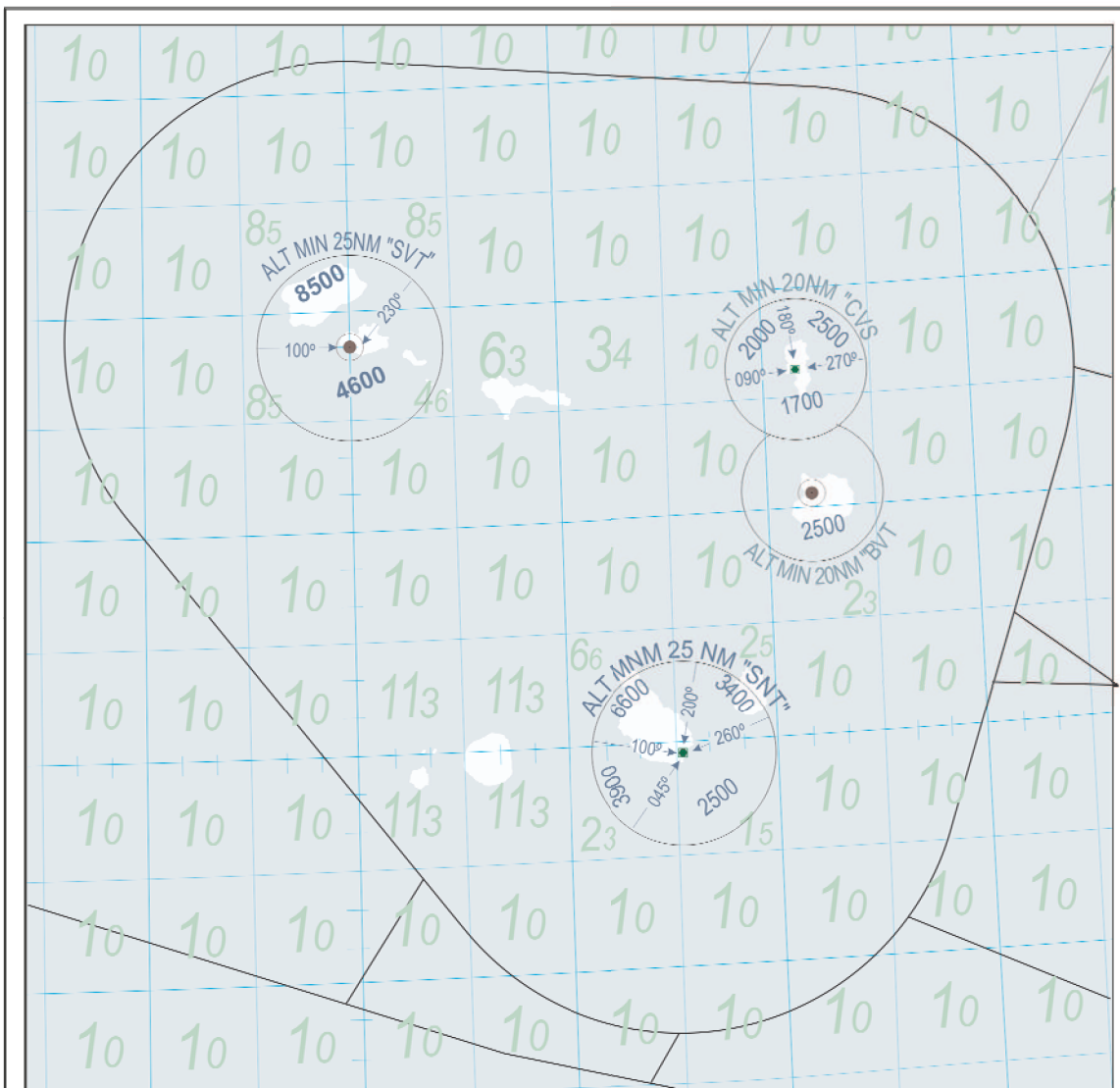

**Area Minimum Altitudes (AMA)**

AMAs in Sal FIR outside TMA are 1000 ft

**Minimum Sector Altitudes (MSA)**

Note: MSAs are related to Radio Aids. Their values precede those of AMA in the areas overlap.

**GVAC MSA**

Three sectors within a circle of 20NM centered on CVS VOR: NE sector between R360 and R090, 2500ft; South sector between R090 and R270, 1700ft; NW sector between R270 and R360.

**GVBA MSA**

A circle of 20NM centered on BVT NDB, 2500ft.

**GVNP MSA**

Four sectors within a circle of 25NM centered on SNT VOR: SW sector between R225 and R080, 3900ft; NW sector between R280 and R020, 6600ft; NE sector between R020 and R080, 3400ft; SE sector between R080 and R225, 2500ft.

**GVSV MSA**

Two sectors within a circle of 25NM centered on SVT NDB: North sector between QDR050 and QDR280, 8500ft; South sector between QDR050 and QDR280, 4600ft.

STANDARD DEPARTURE  
(SID) – ICAO  
DESCRIPTION

AMILCAR CABRAL  
AIRPORT GVAC  
RWYs 01/19

RABIL AIRPORT  
GVBA  
RWYs 03/21

GVAC RWY 01

**BULVO1A** : Climb on runway track till 8 DME/CVS. Turn left to BULVO (RDL219CVS). Remain beyond 10 DME CVS.  
**BULVO1K** : Climb on runway track till passing 2000ft. Turn left to BULVO (RDL219CVS).  
**BVT1A** : Climb on runway track till passing 2500ft and 6 DME/CVS. Turn right direct BVT NDB. Remain beyond 8 DME/CVS.  
**KESIK1A** : Climb on runway track till passing 2000ft. Turn left to KESIK (RDL317CVS) .  
**NCL1A** : Climb on runway track till passing 2000ft. Turn left to intercept and follow RDL272CVS to NCL NDB. MSA 6500ft.  
**PISPU1A** : Climb on runway track till passing 2500ft and 6 DME/CVS. Turn right to PISPU (RDL040CVS).  
**PINPO1A** : Climb on runway track till passing 2500ft and 6 DME/CVS. Turn right to PINPO (RDL057CVS).  
**POLMO1A** : Climb on runway track till passing 2500ft and 6 DME/CVS. Turn right to POLMO (RDL120CVS).  
**RAMOL1A** : Climb on runway track till passing 2500ft and 6 DME/CVS. Turn right to RAMOL (RDL137CVS). Remain beyond 8 DME CVS.  
**SNT1A** : Climb on runway track till 8 DME/CVS. Turn left to intercept and follow RDL206CVS to SNT VOR. Remain beyond 10 DME CVS.  
**SNT1K** : Climb on runway track till passing 2000ft. Turn left to intercept and follow RDL206CVS to SNTVOR. Remain beyond 3 DME CVS.  
**SVT1A** : Climb on runway track till passing 2000ft. Turn left to intercept and follow RDL283CVS to SVT NDB. MSA 4600ft.

GVAC RWY 19

**BULVO1B** : After departure follow R191CVS till 4 DME CVS. Turn right to follow RDL219CVS to BULVO.  
**KESIK1B** : After departure follow R191CVS till 6 DME CVS. Turn right to KESIK (RDL317CVS).. Remain beyond 8 DME/CVS.  
**NCL1B** : After departure follow R191CVS till passing 2000ft or 4 DME CVS. Turn right to intercept and follow RDL272CVS to NCL NDB.  
**PISPU1B** : After departure follow R191CVS till 5 DME CVS. Turn left to intercept and follow arc 7 DME CVS. Crossing R137 follow track029MAG to intercept and follow RDL040CVS to PISPU.  
**PINPO1B** : After departure follow R191CVS till 5 DME CVS. Turn left to intercept and follow arc 7 DME CVS. Crossing R137 follow track044MAG to intercept and follow RDL057CVS to PINPO.  
**POLMO1B** : After departure follow R191CVS till 5 DME CVS. Turn left to intercept and follow arc 7 DME CVS. Crossing R169 follow track099MAG to intercept and follow RDL120CVS to POLMO  
**RAMOL1B** : After departure follow R191CVS till 5 DME CVS. Turn left to intercept and follow arc 7 DME CVS. Crossing R169 follow track099MAG to intercept and follow RDL137CVS to RAMOL.  
**SNT1B** : After departure follow R191CVS till 4DME CVS. Turn right to follow RDL206CVS to SNT VOR.  
**SVT1B** : After departure follow R191CVS till passing 2000ft or 4 DME CVS. Turn right to intercept and follow RDL283CVS to SVT NDB.

GVBA RWY 03

**NCL1C** : Climb on runway heading till passing 1500ft. Turn left to follow track 284MAG to join QDR299BVT to NCL NDB. MSA over NCL6500ft.  
**PISPU1C** : After departure join QDR029BVT to PISPU (RDL040CVS/80DME).  
**PINPO1C** : After departure join QDR041BVT to PINPO (RDL057CVS/80DME).  
**SNT1C** : Climb on runway heading till passing 1500ft. Turn left direct SNT VOR (RDL036SNT).  
**SVT1C** : Climb on runway heading till passing 1500ft. Turn left to follow track 276MAG to join QDR289BVT to SISAU (N162116W0242011/QDR200NCL) then direct SVT NDB on QDR135SVT. MSA 4600ft.

GVBA RWY 21

**NCL1D** : After departure turn right to join QDR299BVT to NCL NDB. MSA over NCL is 6500ft.  
**PISPU1D** : Climb on runway heading till passing 1500ft. Turn right to follow track 044MAG to join QDR029BVT to PISPU(RDL040CVS/80DME).  
**PINPO1D** : Climb on runway heading till passing 1500ft. Turn right to follow track 049MAG to join QDR041BVT to PINPO (RDL057CVS/80DME).  
**SNT1D** : After departure follow QDR216BVT to SNT VOR (RDL037SNT).  
**SVT1D** : After departure turn right to join QDR289BVT to SISAU (N162116 W0242011 / QDR200NCL) then direct SVT NDB on QDR135SVT. MSA 4600ft.

**STANDARD DEPARTURE  
CHART INSTRUMENT  
(SID) - ICAO**

**AMILCAR CABRAL  
AIRPORT GVAC  
RWY 19**

TA: 7000'  
VAR: 10W

APP - 126.400  
TWR - 119.700

TA: 7000'  
VAR: 10W

APP - 126.400  
TWR - 118.900

**RABIL AIRPORT  
GVBA  
RWY 21**

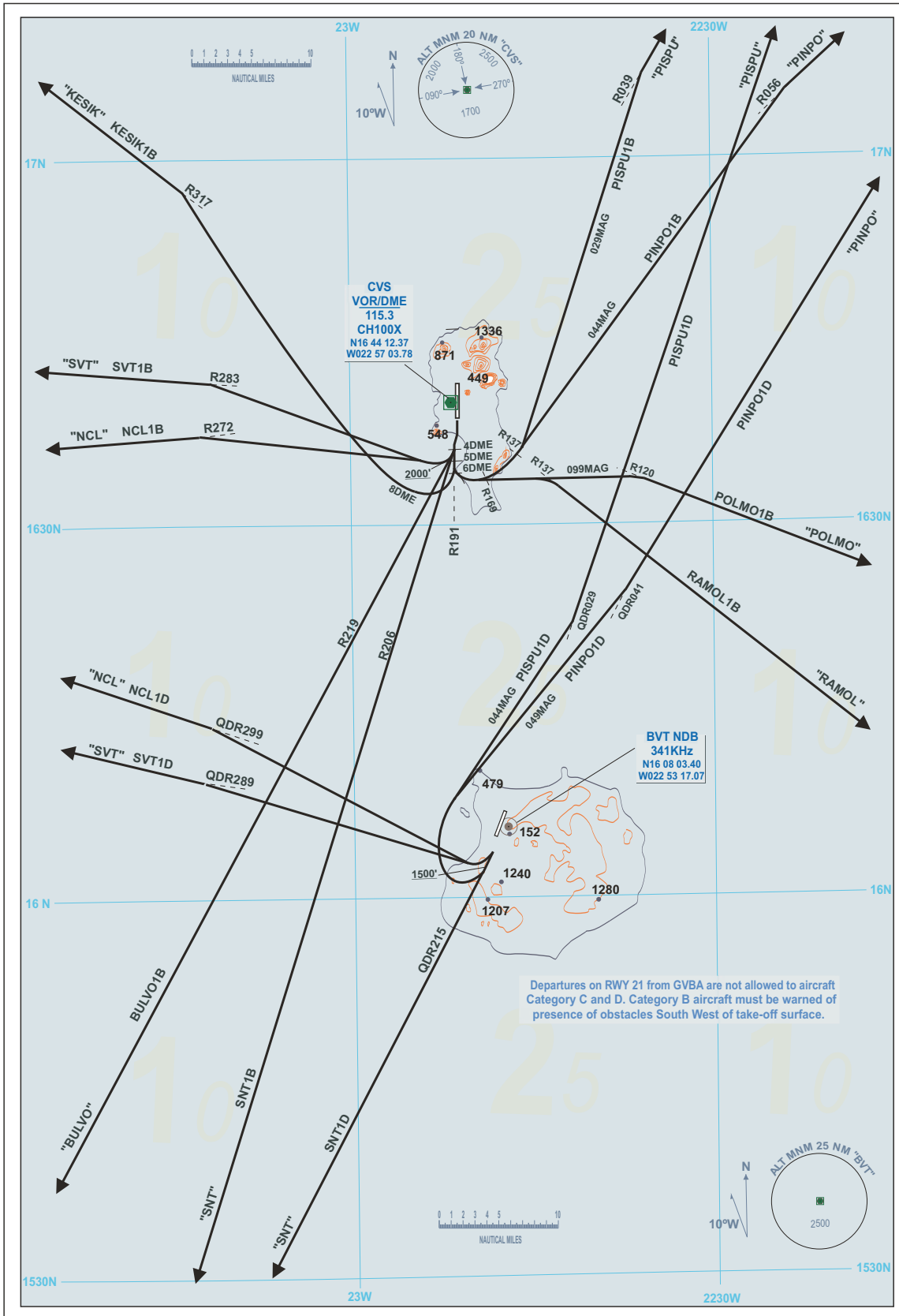

**STANDARD ARRIVAL  
CHART INSTRUMENT  
(STAR) - ICAO**

**AMILCAR CABRAL  
AIRPORT GVAC  
RWYs 01 & 19**

TA: 7000'  
VAR: 10W  
APP - 126.400  
TWR - 119.700

TA: 7000'  
VAR: 10W  
APP - 126.400  
TWR - 118.900

**RABIL AIRPORT  
GVBA  
RWYs 03 & 21**

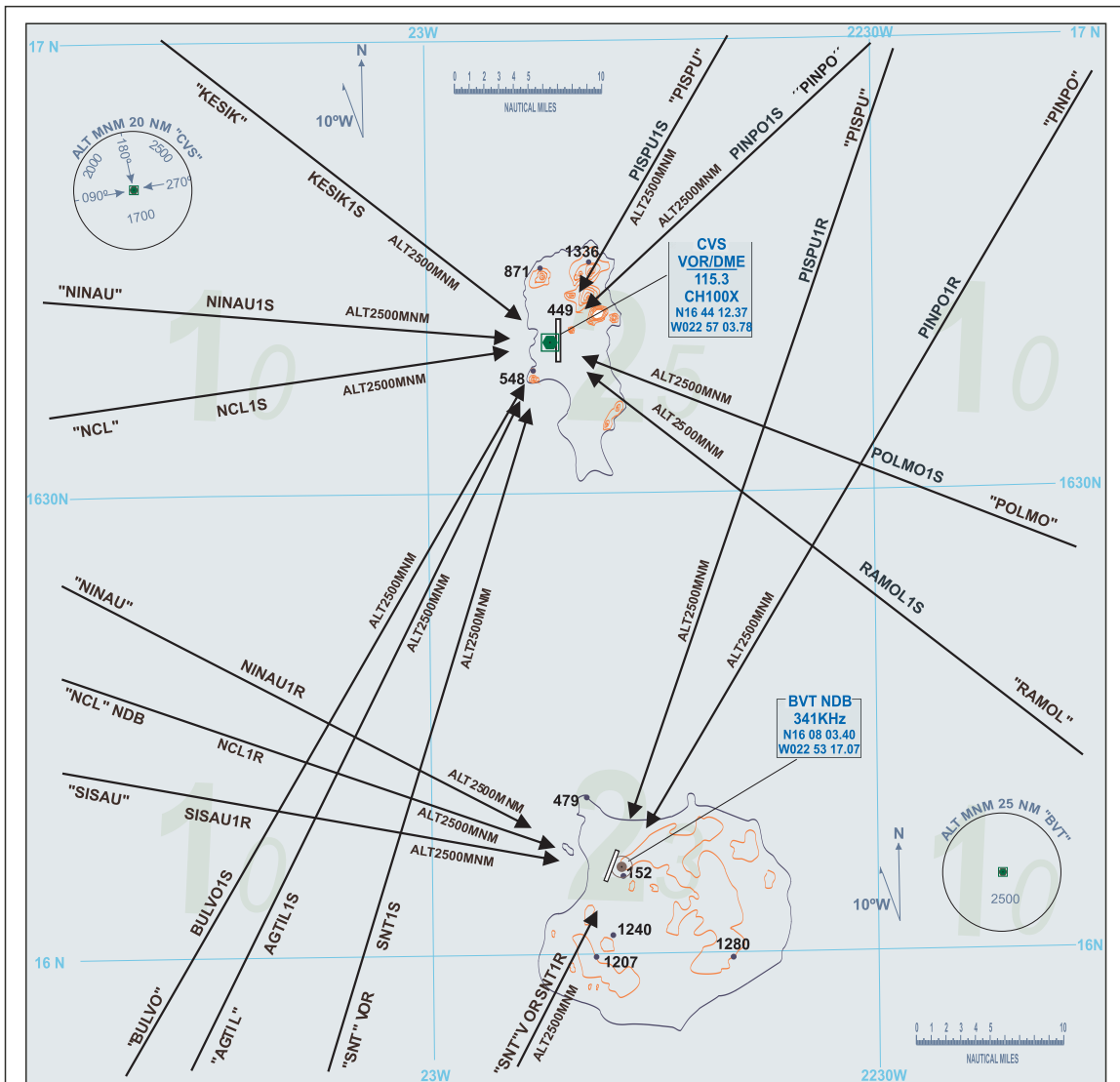

**Note:** Minimum safe altitudes (MSA) are indicated for each leg. Except in case of emergency or loss of communications altitudes to maintain are those assigned by ATC. These must respect the indicated MSAs.

**To GVAC:**

All arrivals proceed direct to CVS VOR MSA 2500ft for an ILS approach or request a visual approach.

**To GVBA:**

All arrivals proceed direct to BVT NDB MSA 2500ft for an ADF approach or request a visual approach.

**INSTRUMENT APPROACH CHART - ICAO**  
**AERODROME ELEV - 184ft**  
**HEIGHTS RELATED TO THR RWY-01 ELEV - 184ft**  
**TWR - 119.70**  
**APP - 126.40**  
**SAL/ AMILCAR CABRAL**  
**VOR/ILS RWY 01**  
**ACFT CAT - A to D**

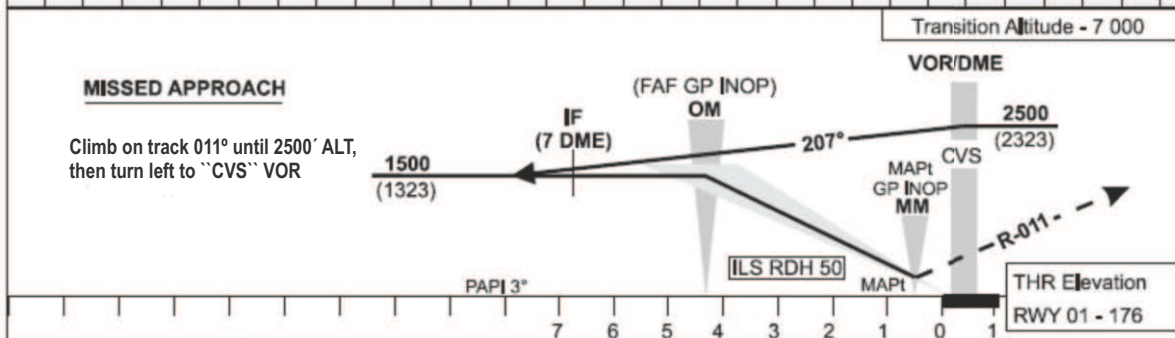
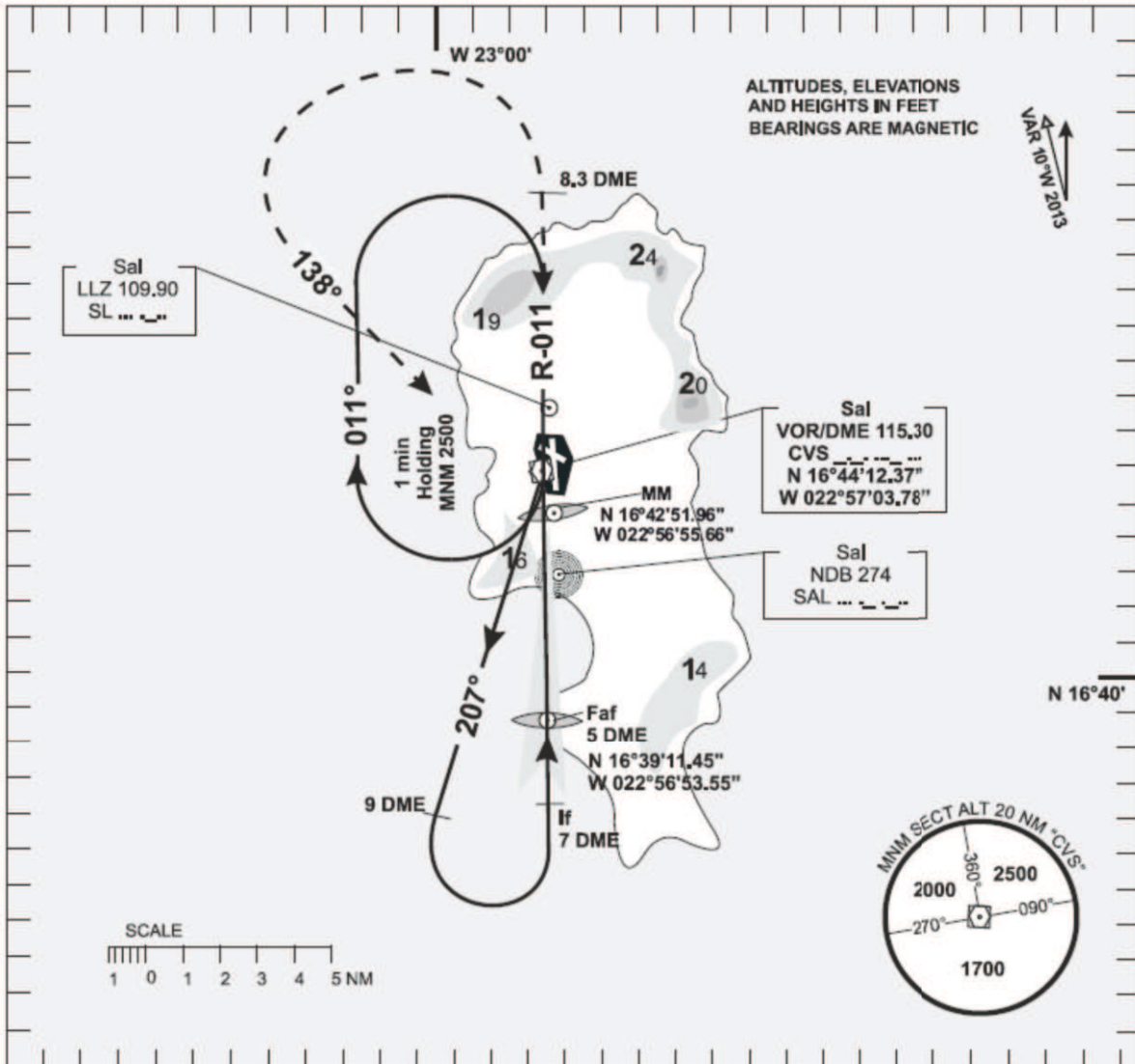

OCA(H)		A	B	C	D								
STRAIGHT - IN APPROACH		379 (202)											
GP INOP		540 (363)				GP INOP OM to MM 3,64 NM (5,2%)							
CIRCLING	EAST RWY 01	750	890	1380	1750	Speed	KT	80	100	120	140	160	180
	WEST RWY 01	750	750	1280	1280	Time	min:s	2:46	2:13	1:51	1:35	1:23	1:14
						RATE	ft/min	420	530	640	740	850	950

**INSTRUMENT**  
**APPROACH**  
**CHART - ICAO**

AERODROME ELEV - 184ft  
HEIGHTS RELATED TO  
TDZ RWY- 01 ELEV - 185ft

TWR - 119.70  
APP - 126.40

**SAL/ AMILCAR CABRAL**

VOR / DME  
RWY 01

ACFT CAT - A to D

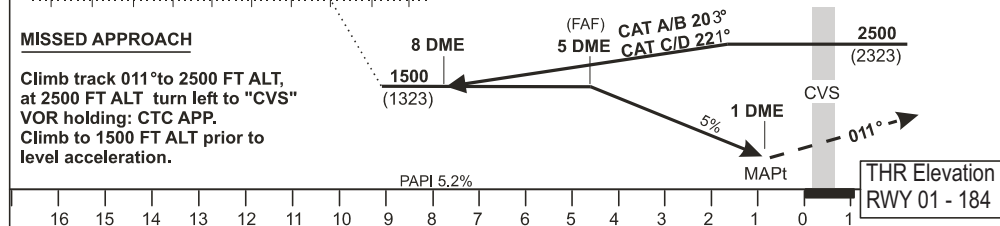
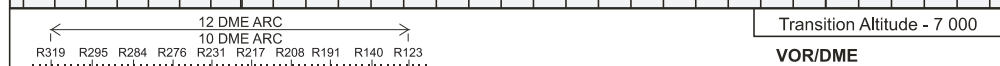
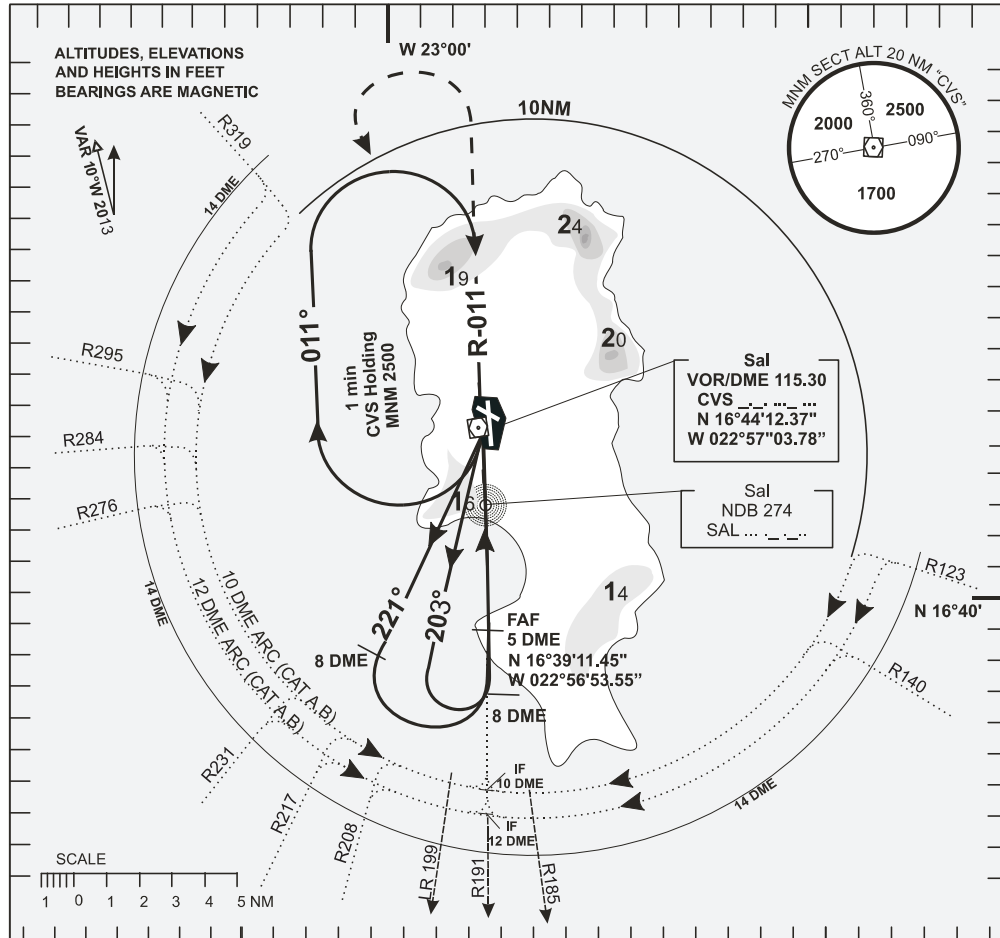

OCA(H)		A	B	C	D		
STRAIGHT - IN APPROACH		540 (363)					
DME-CVS ALTITUDE (HEIGHT)		5 1500 (1323)	4 1200 (1023)	3 900 (723)	2 600 (423)		
5 DME to MAPt							
Speed	KT	80	100	120	140	160	180
Time	min:s	3:00	2:24	2:00	1:43	1:30	1:20
RATE	ft/min	410	510	620	720	820	920
CIRCLING	EAST RWY 01	750	890	1380	1750		
	WESTRWY 01	750	890	1280	1280		

REV : Transition ALT.

**INSTRUMENT APPROACH CHART - ICAO**  
**AERODROME ELEV - 184ft**  
**HEIGHTS RELATED TO THR RWY- 01 ELEV - 184ft**  
**TWR - 119.70**  
**APP - 126.40**  
**SAL/AMILCAR CABRAL**  
**NDB/ILS RWY 01**  
**ACFT CAT - A to D**

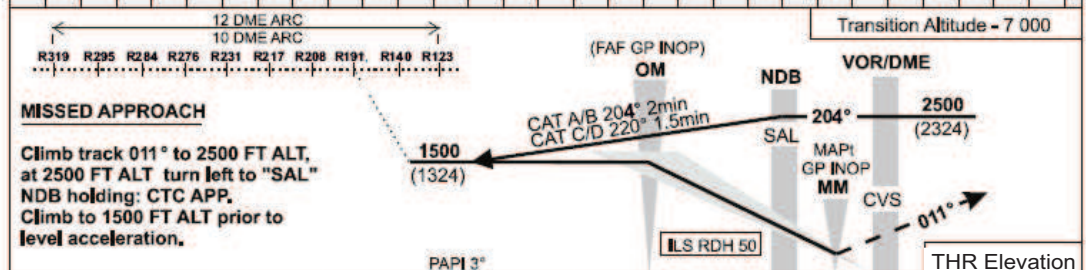
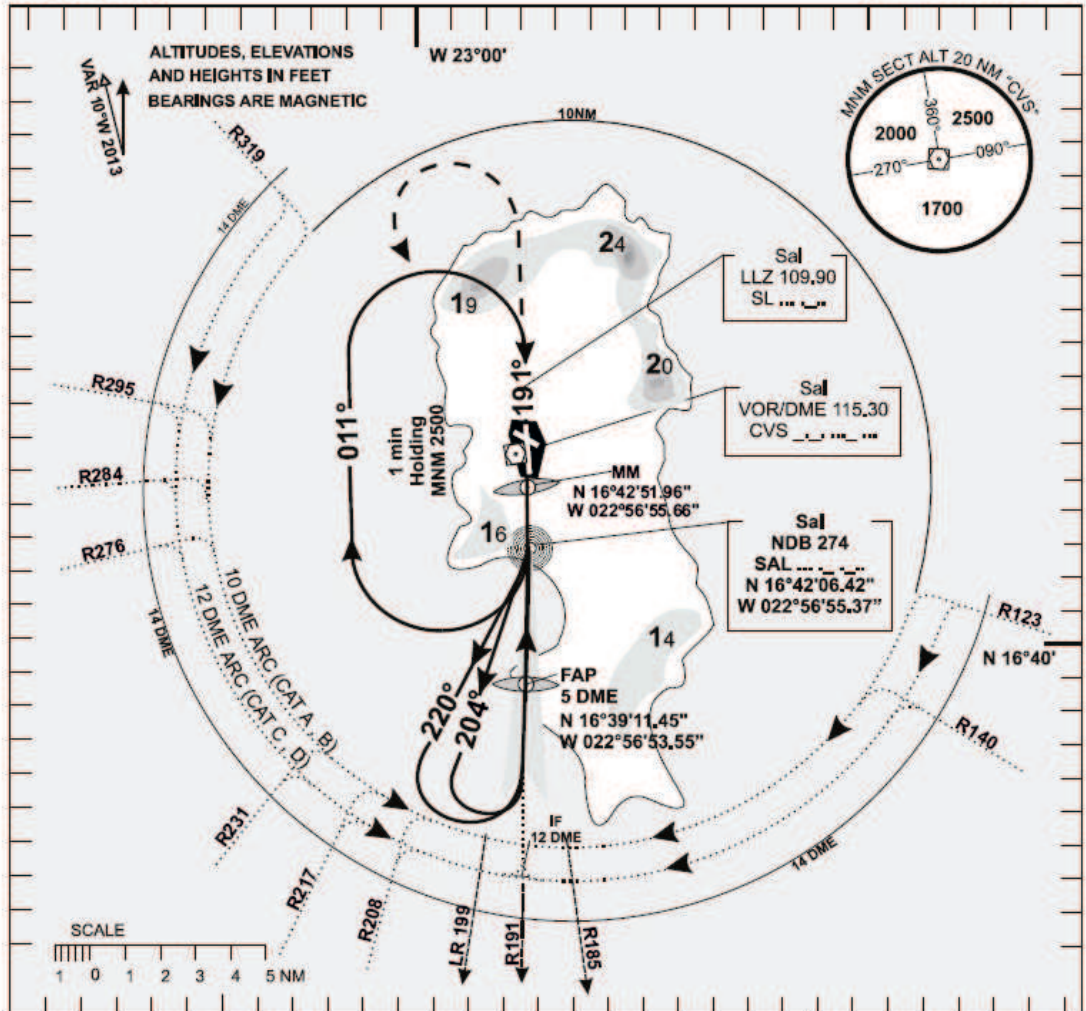

ILS - CAT 1 OCA(H)	A	B	C	D	
STRAIGHT - IN APPROACH		379 (202)			
GP INOP		540 (363)			
CIRCLING	EAST RWY 01	750	890	1380	1750
	WEST RWY 01	750	750	1280	1280

GP INOP OM to MM 3.64 NM (5.2%)							
Speed	KT	80	100	120	140	160	180
Time	min:s	2:46	2:13	1:51	1:35	1:23	1:14
RATE	ft/min	420	530	640	740	850	950

REV : Transition ALT.



**INSTRUMENT  
APPROACH  
CHART - ICAO**

**AERODROME ELEV - 184 ft  
HEIGHTS RELATED TO  
TDZ RWY- 01 ELEV - 185 ft**

**TWR - 119.70  
APP - 126.40**

**SAL/ AMILCAR CABRAL**

**NDB  
RWY 01**

ACFT CAT - A to D

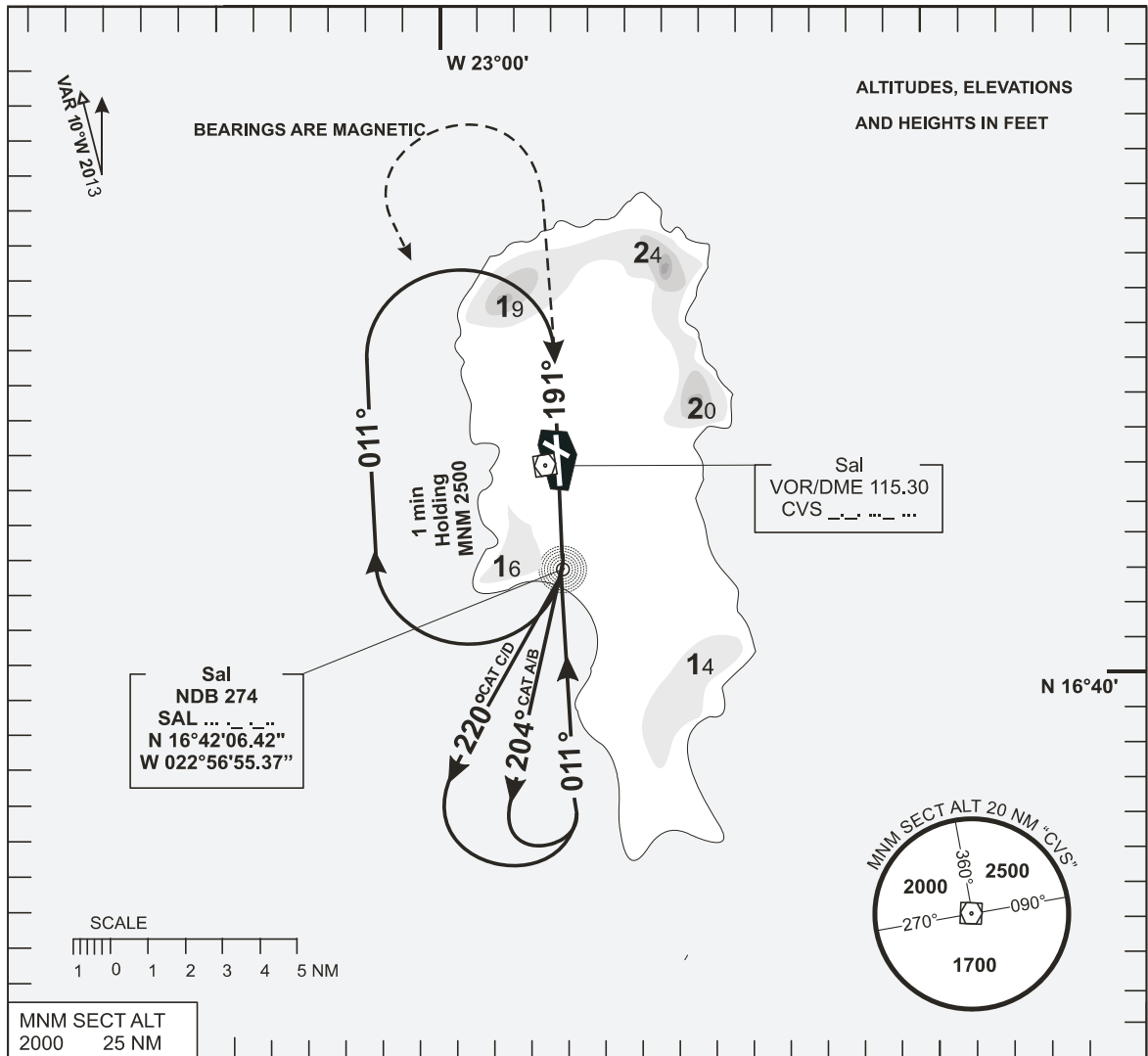

MNM SECT ALT  
2000 25 NM

Transition Altitude - 7 000

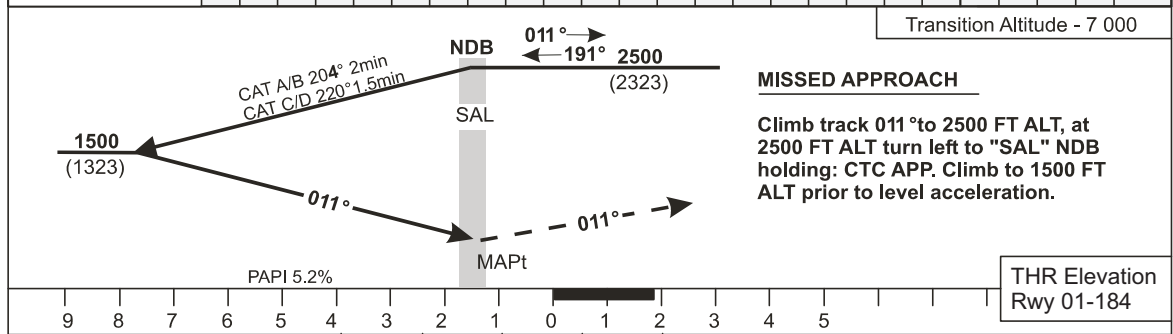

**MISSED APPROACH**

Climb track 011° to 2500 FT ALT, at 2500 FT ALT turn left to "SAL" NDB holding: CTC APP. Climb to 1500 FT ALT prior to level acceleration.

THR Elevation  
Rwy 01-184

REV : Transition ALT.

OCA(H)		A	B	C	D
STRAIGHT - IN APPROACH		550 (373)			
CIRCLING	EAST RWY 01	750	890	1380	1750
	WEST RWY 01	750	750	1280	1280

**INSTRUMENT  
APPROACH  
CHART - ICAO**

**AERODROME ELEV - 184ft  
HEIGHTS RELATED TO  
TDZ RWY-19 ELEV - 178ft**

**TWR - 119.70  
APP - 126.40**

**SAL/ AMILCAR CABRAL**

**VOR/DME  
RWY 19**

ACFT CAT - A to D

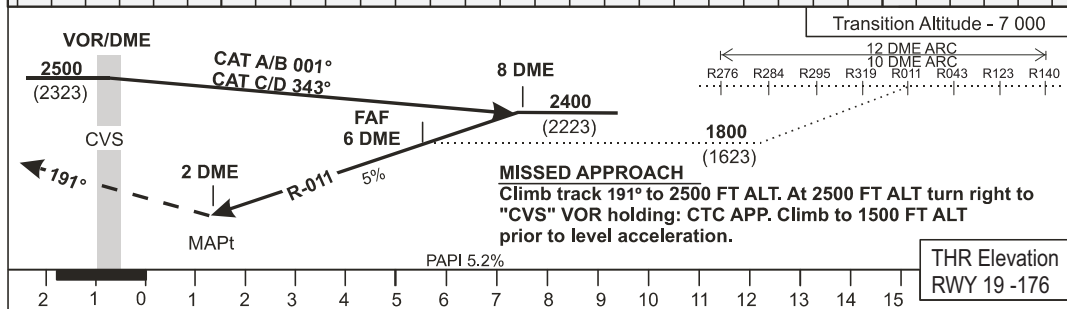
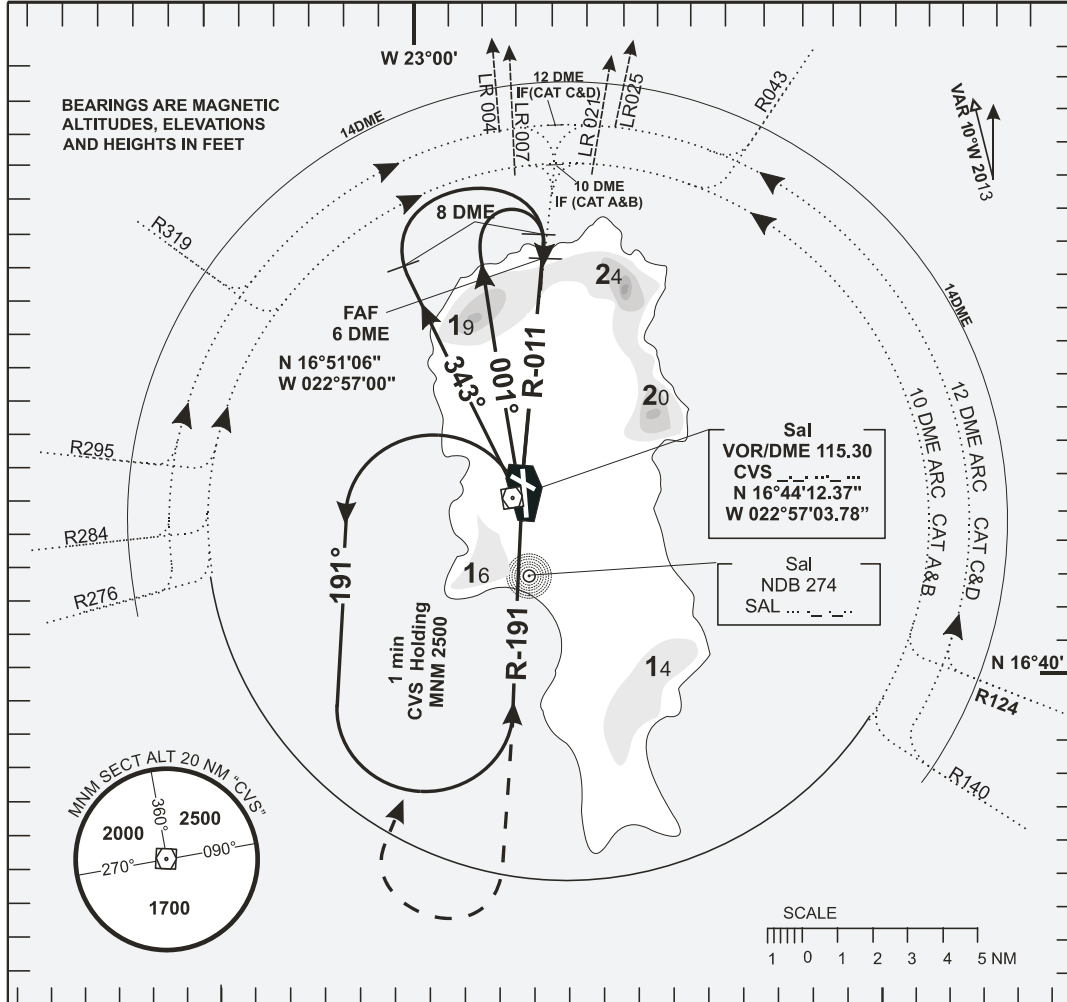

REV : Transition ALT.	OCA(H)	A	B	C	D								
	STRAIGHT - IN APPROACH	720 (543)											
	CIRCLING	EAST RWY 01	750	890	1380	1750							
		WESTRWY 01	750	750	1280	1280							
							DME-CVS						
							ALTITUDE	1800	1500	1200	900		
							(HEIGHT)	(1640)	(1340)	(940)	(740)		
							FAF 6 DME to MAPt						
Speed		KT	80	100	120	140	160	180					
Time		min:s	3:00	2:24	2:00	1:43	1:30	1:20					
RATE		ft/min	410	510	620	720	820	920					

**GVBA AD 2.1 AERODROME LOCATION INDICATOR AND NAME**

GVBA - RABIL / ARISTIDES PEREIRA

**GVBA AD 2.2 AERODROME GEOGRAPHICAL AND ADMINISTRATIVE DATA**

1	ARP coordinates and site at AD	160814N 0225319W Midpoint of RWY 03 / 21
2	Direction and distance from city	5 KM SE of Sal Rei
3	Elevation / Reference temperature / Mean low temperature	27.73 M (91 FT) / 30° C / NIL
4	Geoid Undulation at AD ELEV PSN	31.6 M (103.7 FT)
5	MAG VAR / Date of information / Annual change	10°W (2013) / 0.12° decreasing
6	AD operator, address, telephone, telefax, e-mail, AFS, website	ASA - Empresa Nacional de Aeroportos e Seguranca Aerea - S.A. Aeroporto Aristides Pereira Rabil Boa Vista Island Republic of Cabo Verde TEL: +238 2519000 (Admin) +238 2519001 (Admin) +238 2511924 (Admin) Telefax:+238 2511000 (Admin) TEL: +238 2511070 (Airport Operations) +238 9817265 (Airport Operations) Telefax:+238 2511193 (Airport Operations) e-mail: NIL AFS: GVBAYDYX Http: NIL
7	Types of traffic permitted (IFR/VFR)	IFR / VFR
8	Remarks	Restricted to daylight operations only

**GVBA AD 2.3 OPERATIONAL HOURS**

1	AD operator	09:00 - 19:00
2	Customs and immigration	09:00 - 19:00
3	Health and sanitation	09:00 - 19:00
4	AIS Briefing office	09:00 - 19:00
5	ATS Reporting office (ARO)	09:00 - 19:00
6	MET Briefing office	09:00 - 19:00
7	ATS	09:00 - 19:00
8	Fuelling	09:00 - 19:00
9	Handling	09:00 - 19:00
10	Security	09:00 - 19:00
11	De-icing	NIL
12	Remarks	NIL

#### GVBA AD 2.4 HANDLING SERVICES AND FACILITIES

1	<i>Cargo handling facilities</i>	High loader, conveyer belts, air starter 40 PSI / 270 PPM, tow tractor MAX 18 TON pull, GPU, toilet cleaning services, ambulift MAX 900 KG capacity for 6 wheelchairs, manual and engined stairs, tow tractor MAX 3 TON pull, tow bars for Boeing 737 - 200, 737 - 300, 737 - 400, 737 - 500, 737 - 600, 737 - 700 and 737 - 800 and for Airbus A319, A320, A321 and A310
2	<i>Fuel / oil types</i>	Jet A1 / NIL
3	<i>Fuelling facilities / capacity</i>	Fuel provided on trucks / NIL
4	<i>De-icing facilities</i>	NIL
5	<i>Hangar space for visiting aircraft</i>	NIL
6	<i>Repair facilities for visiting aircraft</i>	NIL
7	<i>Remarks</i>	NIL

#### GVBA AD 2.5 PASSENGER FACILITIES

1	<i>Hotel(s)</i>	In Sal - Rei town
2	<i>Restaurant(s)</i>	At AD and in Sal - Rei town
3	<i>Transportation</i>	Buses, taxis and car rental
4	<i>Medical facilities</i>	First aid, ambulance at AD, hospital in Sal - Rei town and medical centre in Rabil town
5	<i>Bank and Post office</i>	At AD and in Sal - Rei town
6	<i>Tourist office</i>	In Sal - Rei town
7	<i>Remarks</i>	NIL

#### GVBA AD 2.6 RESCUE AND FIRE FIGHTING SERVICES

1	<i>AD category for fire fighting</i>	CAT 7
2	<i>Rescue equipment</i>	As specified in ICAO DOC 9137 table 5 - 2
3	<i>Capability for removal of disabled aircraft</i>	All operators are required to put in place appropriate agreements for the supply of equipment for the removal of disabled aircraft at the airport movement area or at its proximity and to ensure its use when required. Operators are also required to submit such agreements for airport administration appraisal and recording.
4	<i>Remarks</i>	NIL

#### GVBA AD 2.7 SEASONAL AVAILABILITY - CLEARING

1	<i>Type(s) of clearing equipment</i>	NIL
2	<i>Clearance priorities</i>	NIL
3	<i>Remarks</i>	NIL

**GVBA AD 2.8 APRONS, TAXIWAYS AND CHECK LOCATIONS / POSITIONS DATA**

1	<i>Apron designation, surface and strength</i>	Designation: APRON 1 Surface: Concrete / Asphalt Strength: PCN 62 / F / B / Y / T PCN 57 / F / B / Y / T Designation: APRON 2 Surface: NIL Strength: 20 TON SIWL
2	<i>Taxiway designation, width, surface and strength</i>	Designation: TWY A Width: 27 M Surface: Asphalt Strength: PCN 54 / F / A / X / U Designation: TWY B Width: 28 M Surface: Asphalt Strength: PCN 57 / F / B / Y / T Designation: TWY Y Width: 21 M Surface: Asphalt Strength: 20 TON SIWL Designation: TWY Z Width: 25 M Surface: Asphalt Strength: PCN 57 / F / B / Y / T
3	<i>Altimeter checkpoint location and elevation</i>	Whole parking area 17.56 M (57.612 FT)
4	<i>VOR checkpoints</i>	NIL
5	<i>INS checkpoints</i>	NIL
6	<i>Remarks</i>	NIL

**GVBA AD 2.9 SURFACE MOVEMENT GUIDANCE AND CONTROL SYSTEM AND MARKINGS**

1	Use of aircraft stand ID signs, TWY guide lines and visual docking/parking guidance system at aircraft stands	Taxiing guidance exiting RWYs. Taxiing guidance signs at all intersections with TWY and RWY at all holding positions. Guidelines on APRON1. Aircraft stand markings. APRON1 nose - in guidance to stands 1, 1A, 2, 2A, 3, 3A, 4 and 5.
2	<i>RWY and TWY markings and lights</i>	RWY: Designation, aiming point, TDZ, THR, shoulder, edge, CL TWY: RWY holding position, CL
3	<i>Stop Bars and RWY guard lights</i>	NIL
4	<i>Other RWY protection measures</i>	NIL
5	<i>Remarks</i>	NIL

**GVBA AD 2.10 AERODROME OBSTACLES**

<i>In Area 2</i>						
<i>OBST ID / Designation</i>	<i>OBST type</i>	<i>OBST position</i>		<i>ELEV / HGT</i>	<i>Markings / Type / Colour of lighting</i>	<i>Remarks</i>
<i>a</i>	<i>b</i>	<i>c</i>	<i>d</i>	<i>e</i>	<i>f</i>	
GVBA001	High grounds	160846.85N	0225305.11W	90 FT / 15 FT	NIL	NIL
GVBA001	Water tanks	160726.02N	0225321.86W	158 FT / 101 FT	NIL	NIL

<i>In Area 3</i>						
<i>OBST ID / Designation</i>	<i>OBST type</i>	<i>OBST position</i>		<i>ELEV / HGT</i>	<i>Markings / Type / Colour of lighting</i>	<i>Remarks</i>
<i>a</i>	<i>b</i>	<i>c</i>	<i>d</i>	<i>e</i>	<i>f</i>	
NIL	NIL	NIL	NIL	NIL	NIL	NIL

<i>In Area 4</i>						
<i>OBST ID / Designation</i>	<i>OBST type</i>	<i>OBST position</i>		<i>ELEV / HGT</i>	<i>Markings / Type / Colour of lighting</i>	<i>Remarks</i>
<i>a</i>	<i>b</i>	<i>c</i>		<i>d</i>	<i>e</i>	<i>f</i>
GVBA003	Power lines	160724.73N	0225331.52W	95 FT / 38 FT	NIL	NIL

**GVBA AD 2.11 METEOROLOGICAL INFORMATION PROVIDED**

1	<i>Associated MET office</i>	Aeronautical MET Station
2	<i>Hours of service</i> <i>MET office outside hours</i>	09:00 - 19:00 NIL
3	<i>Office responsible for TAF preparation</i> <i>Periods of validity</i> <i>Interval of issuance</i>	Analysis and weather forecast centre GVACYMYX 24 HR NIL
4	<i>Availability of TREND forecast</i> <i>Interval of issuance</i>	NIL
5	<i>Briefing / Consultation provided</i>	NIL
6	<i>Flight documentation</i> <i>Language(s) used</i>	NIL
7	Charts and other information displayed or available for briefing or consultation	NIL
8	Supplementary equipment available for providing information	Automated Weather Observing System (AWOS). Meteorological parameters available: Surface wind for both RWYs, visibility, temperature, dew point, relative humidity, sky conditions, cloud height and amount, altimeter setting and rainfall.
9	<i>ATS units provided with information</i>	BOAVISTA TWR, SAL APP, SAL ACC
10	<i>Additional information (Limitation of service, etc.)</i>	Aviation meteorological parameters permanently broadcast on 127.000 MHZ

**GVBA AD 2.12 RUNWAY PHYSICAL CHARACTERISTICS**

<i>Designations RWY NR</i>	<i>True BRG</i>	<i>Dimensions of RWY(M)</i>	<i>Strength (PCN) and surface of RWY and SWY</i>	<i>THR coordinates RWY end coordinates THR geoid undulation</i>	<i>THR elevation and highest elevation of TDZ of precision APP RWY</i>
<i>1</i>	<i>2</i>	<i>3</i>	<i>4</i>	<i>5</i>	<i>6</i>
03	016.68°	2100 X 45	PCN 71 F / B / W / T NIL	160741.67N 0225329.10W 160741.86N 0225329.05W 103.7 FT	56.6 FT 57.1 FT
21	196.68°	2100 X 45	PCN 71 F / B / W / T NIL	160847.12N 0225308.82W 160846.93N 0225308.88W 103.7 FT	90.8 FT 78.7 FT

<i>Slope of RWY-SWY</i>	<i>SWY dimensions (M)</i>	<i>CWY dimensions (M)</i>	<i>Strip dimensions (M)</i>	<i>RWY end safety area (M)</i>	<i>Location / description of arresting system</i>	<i>OFZ</i>	<i>Remarks</i>
<i>7</i>	<i>8</i>	<i>9</i>	<i>10</i>	<i>11</i>	<i>12</i>	<i>13</i>	<i>14</i>
0.5 %	NIL	NIL	2250 X 150	90 X 90	NIL	NIL	Turning loops at RWY THR
0.5 %	NIL	NIL	2250 X 150	90 X 90	NIL	NIL	Turning loops at RWY THR

**GVBA AD 2.13 DECLARED DISTANCES**

<i>RWY Designator</i>	<i>TORA (M)</i>	<i>TODA (M)</i>	<i>ASDA (M)</i>	<i>LDA (M)</i>	<i>Remarks</i>
1	2	3	4	5	6
03	2100	2100	2100	2100	NIL
21	2100	2100	2100	2100	NIL

**GVBA AD 2.14 APPROACH AND RUNWAY LIGHTING**

<i>RWY Designator</i>	<i>APCH LGT type LEN INTST</i>	<i>THR LGT colour WBAR</i>	<i>VASIS (MEHT) PAPI</i>	<i>TDZ LGT LEN</i>	<i>RWY CL LGT LEN, spacing, colour, INTST</i>	<i>RWY edge LGT LEN, spacing, colour INTST</i>	<i>RWY end LGT colour WBAR</i>	<i>SWY LGT LEN colour</i>	<i>Remarks</i>
1	2	3	4	5	6	7	8	9	10
03	NIL	green	PAPI 3° (66 FT)	NIL	NIL	NIL	red	NIL	NIL
21	NIL	green	PAPI 3° (66 FT)	NIL	NIL	NIL	red	NIL	NIL

**GVBA AD 2.15 OTHER LIGHTING SECONDARY POWER SUPPLY**

1	ABN / IBN location, characteristics and hours of operation	NIL
2	WDI / LDI / Anemometer location and LGT	WDI: 300 M left hand of each RWY. LGTD / NIL / NIL
3	TWY ledge and CL lighting	Elevated edge blue reflectors / NIL
4	Secondary power supply / switch - over time	7 SEC
5	Remarks	Apron: Elevated edge blue reflectors on corners Obstruction: Fixed red obstruction lights on the WDI masts, NDB aerial and AWOS sensor towers

**GVBA AD 2.16 HELICOPTER LANDING AREA**

1	Coordinates TLOF or THR of FATO Geoid undulation	NIL
2	TLOF and / or FATO elevation M / FT	NIL
3	TLOF and FATO area dimensions, surface, strength, marking	NIL
4	True BRG of FATO	NIL
5	Declared distance available	NIL
6	APP and FATO lighting	NIL
7	Remarks	NIL

**GVBA AD 2.17 ATS AIRSPACE**

1	Designation and lateral limits	BOAVISTA ATZ Circle radius 5 NM centred on 160814N 0225319W (Rabil / Aristides Pereira ARP)
2	Vertical limits	GND / MSL - 1500 FT
3	Airspace classification	Class C

4	ATS unit call sign Language(s)	BOAVISTA TWR English, Portuguese
5	Transition altitude	7000 FT
6	Hours of applicability	09:00 - 19:00
7	Remarks	NIL

**GVBA AD 2.18 ATS COMMUNICATION FACILITIES**

Service designation	Call sign	Channel(s)	SATVOICE number(s)	Logon address	Hours of operation	Remarks
1	2	3	4	5	6	7
TWR	BOAVISTA TWR	118.900 MHZ 121.500 MHZ	NIL	NIL	09:00 - 19:00 09:00 - 19:00	NIL Emergency

**GVBA AD 2.19 RADIO NAVIGATION AND LANDING AIDS**

Type of aid, MAG VAR Type of supported OPS (For VOR / ILS give declination)	ID	Frequency(ies) Channel number(s) service provider RPI	Hours of operation	Position of transmitting antenna coordinates	Elevation of the transmitting antenna of DME, GBAS reference point	Service volume radius from GBAS reference point	Remarks
1	2	3	4	5	6	7	8
NDB 11°W	BVT	341 KHZ	H 24	160803.4N 0225317.0W	NIL	NIL	Coverage: 50 NM



## GVBA AD 2.20 LOCAL TRAFFIC REGULATIONS

### 1. Aerodrome regulations

- a) Slots available - Coordinated level 3 airport
- b) Operation with B 752, B 753, B 762, B 763, B 763ER and A 310 are allowed.

### 2. Taxiing to and from stands

Nose - in guidance to stands 1, 1A, 2, 2A, 2B, 3, 3A, 4 and 5, according to TWR and marshaller instruction.

### 3. Parking area for small aircraft (general aviation)

Night stop parking area for small aircraft (general aviation) available. General aviation aircraft shall be guided by follow me and marshalls to the night stop parking area.

### 4. Parking area for helicopters

NIL

### 5. Apron - Taxiing during winter conditions

NIL

### 6. Taxiing - Limitations

180° turns on the RWY are forbidden for aircraft MTOW above 30 TON. These operations must be done only on the turning bay of each RWY.

### 7. School and training flights - Technical test flights - Use of runways

NIL

### 8. Helicopter traffic - Limitations

NIL

### 9. Removal of disabled aircraft from runways

When an aircraft is wrecked on the runway it is the duty of the owner or user of such aircraft to have it removed as soon as possible. If a wrecked aircraft is not removed from the runway as quickly as possible by the owner of the user, the aircraft will be removed by the aerodrome authority at the owner's expenses.

### 10. Aircraft safety area

All staff and equipment shall remain outside the aircraft safety area of the designated parking position until the aircraft engines are completely stopped, anti collision lights are off and shocks are on.

### 11. Take off limitations

Based on ICAO Annex 14 aerodrome reference code, take - off from RWY21 is allowed under the following conditions:

RWY21 is not allowed to aircraft category C and D except ATR 72 - 500 aircraft. Category B aircraft shall be warned of obstacles on the take - off surface.

## GVBA AD 2.21 NOISE ABATEMENT PROCEDURES

NIL

## GVBA AD 2.22 FLIGHT PROCEDURES

### 1. General

chapter 6 (six) Para 6.5.3.3 are met visual approach may be cleared by ATC. Pilots are strongly warned not to join RWY 03 approach using 3 degree PAPI beyond 4.5 NM from ARP.

#### 1.1 Radar vectoring area

NIL

#### 1.2 Minimum Sector Altitude (MSA)

2500 FT, a circle of 25 NM centred on NDB BVT.

### 2. Procedures for IFR flights within SAL CTR

- a) See **GVAC AD 2.22.2** FLIGHT PROCEDURES, Procedures for IFR flights within SAL CTR.
- b) After establish contact with SAL CONTROL or SAL APPROACH and as soon as practicable, RNAV approach clearance may be requested by the pilot after checking that it can be carried out, including RAIM availability.
- c) Pilots under IFR flight, using NDB facility, inbound GVBA for landing RWY 03 shall expect from ATC an instrument approach RWY 21 - Circling RWY 03 clearance. Following pilots request and if conditions as specified in ICAO Doc 4444 (PANS / ATM).

### 3. Radar procedures within SAL CTR

See **GVAC AD 2.22.2** FLIGHT PROCEDURES, Procedures for IFR flights within SAL CTR.

### 4. Procedures for VFR flights within SAL CTR

See **GVAC AD 2.22.2** FLIGHT PROCEDURES, Procedures for IFR flights within SAL CTR.

### 5. Procedures for VFR flights within BOAVISTA ATZ

- a) Flight plan shall be filed for the flight concerned.
- b) ATC clearance shall be obtained from the Control Tower.
- c) A revised ATC clearance must be obtained before any deviation from the clearance in force.
- d) Two - way radio communication shall be established on the prescribed frequency before flights take place in the ATZ.

## GVBA AD 2.23 ADDITIONAL INFORMATION

- 1. Isolated aircraft parking position located at THR RWY 21.
- 2. In accordance with Cape Verde aeronautical code for slot regulation have changed from level 2 to level 3 scheduling coordinated airports by degree law 10 / 2016 of February 22, with effect from winter 2017. Request for slots shall be filled in standard IATA format (standard schedules information manual,

chapter 6, and worldwide scheduling guidelines) to slot.coordination@asa.cv.

**GVBA AD 2.24 CHARTS RELATED TO AN AERODROME**

<i>Chart name</i>	<i>Page</i>
AERODROME CHART - ICAO	GVBA AD 2-9
AIRCRAFT PARKING / DOCKING CHART - ICAO	GVBA AD 2-10
AERODROME OBSTACLE CHART RWY 03 - ICAO TYPE A	GVBA AD 2-11
AERODROME OBSTACLE CHART RWY 07 (OBSTACLE REFERENCE POINTS)	GVBA AD 2-12
AERODROME OBSTACLE CHART RWY 21 - ICAO TYPE A - 1	GVBA AD 2-13
AERODROME OBSTACLE CHART RWY 21 - ICAO TYPE A - 2	GVBA AD 2-14
STANDARD DEPARTURE CHART - INSTRUMENT (SID) RWY 03 - ICAO	GVBA AD 2-15
STANDARD DEPARTURE CHART - INSTRUMENT (SID) RWY 03 (VERSO) - ICAO	GVBA AD 2-16
STANDARD DEPARTURE CHART - INSTRUMENT (SID) RNAV (GNSS) RWY 03 - ICAO	GVBA AD 2-17
STANDARD DEPARTURE CHART - INSTRUMENT (SID) RNAV (GNSS) RWY 03 (VERSO) - ICAO	GVBA AD 2-18
STANDARD DEPARTURE CHART - INSTRUMENT (SID) RWY 21 - ICAO	GVBA AD 2-19
STANDARD DEPARTURE CHART - INSTRUMENT (SID) RNAV (GNSS) RWY 21 - ICAO	GVBA AD 2-20
STANDARD DEPARTURE CHART - INSTRUMENT (SID) RNAV (GNSS) RWY 21 (VERSO) - ICAO	GVBA AD 2-21
STANDARD ARRIVAL CHART - INSTRUMENT (STAR) RNAV (GNSS) RWY 03 - ICAO	GVBA AD 2-22
STANDARD ARRIVAL CHART - INSTRUMENT (STAR) RNAV (GNSS) RWY 03 (VERSO) - ICAO	GVBA AD 2-23
STANDARD ARRIVAL CHART - INSTRUMENT (STAR) RNAV (GNSS) RWY 21 - ICAO	GVBA AD 2-24
STANDARD ARRIVAL CHART - INSTRUMENT (STAR) RNAV (GNSS) RWY 21 (VERSO) - ICAO	GVBA AD 2-25
STANDARD ARRIVAL CHART - INSTRUMENT (STAR) RWY 03 / 21 - ICAO	GVBA AD 2-26
INSTRUMENT APPROACH CHART RNAV (GNSS) RWY 03 - ICAO	GVBA AD 2-27
INSTRUMENT APPROACH CHART RNAV (GNSS) RWY 03 (VERSO) - ICAO	GVBA AD 2-28
INSTRUMENT APPROACH CHART RNAV (GNSS) RWY 21 - ICAO	GVBA AD 2-29
INSTRUMENT APPROACH CHART RNAV (GNSS) RWY 21 (VERSO) - ICAO	GVBA AD 2-30
INSTRUMENT APPROACH CHART NDB RWY 21 CAT A - D - ICAO	GVBA AD 2-31
VISUAL APPROACH CHART - ICAO	GVBA AD 2-32

**AERODROME  
CHART - ICAO**

16° 08' 14" N  
022° 53' 19" W

ELEV - 91ft

TWR 118.9  
APP 126.4

**BOA VISTA/RABIL  
AERODROME**

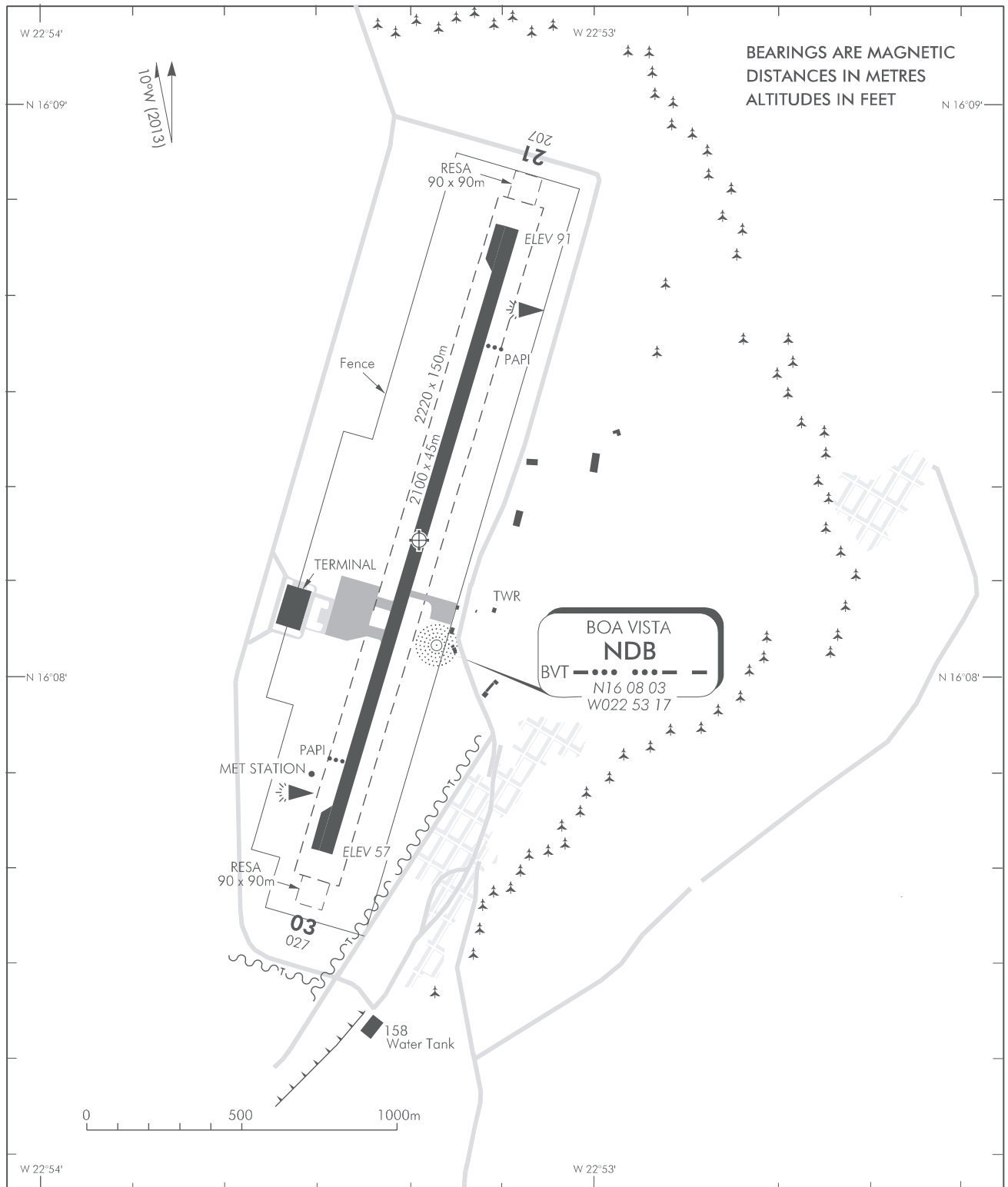

RWY	DIRECTION	THR	BEARING	STRENGTH	LIGHTING				
					RWY	PAPIS	APPROACH	THRESHOLD	RUNWAY
03	16.7°T 27°M	16° 07' 41.67"N 022° 53' 29.10"W	PCN54/F/A/X/U						
21	196.7°T 207°M	16° 08' 47.12"N 022° 53' 08.82"W	PCN54/F/A/X/U						
					03	3°	Nil	Green	Red
					21	3°	Nil	Green	Red
HELIPORT					OTHER: Taxiways				

**AIRCRAFT PARKING/DOCKING  
CHART-ICAO**

TWR118.9  
APRONELEV. 57,612ft/17.56m

**AEROPORTO INTERNACIONAL  
DORABIL-BOAVISTA**

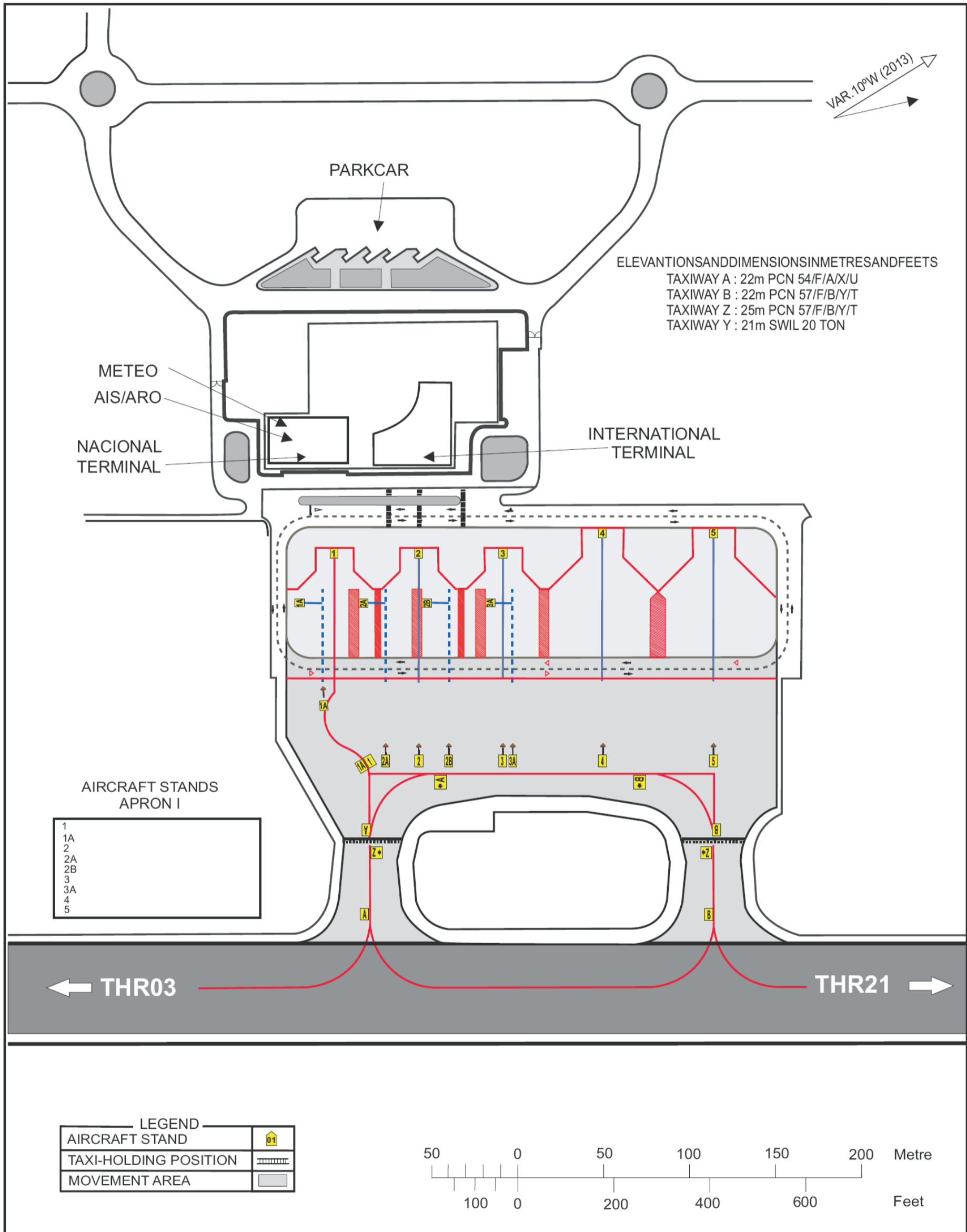

TYPE A (OPERATING LIMITATIONS)

RABIL INTERNATIONAL AIRPORT - BOA VISTA

RWY 03

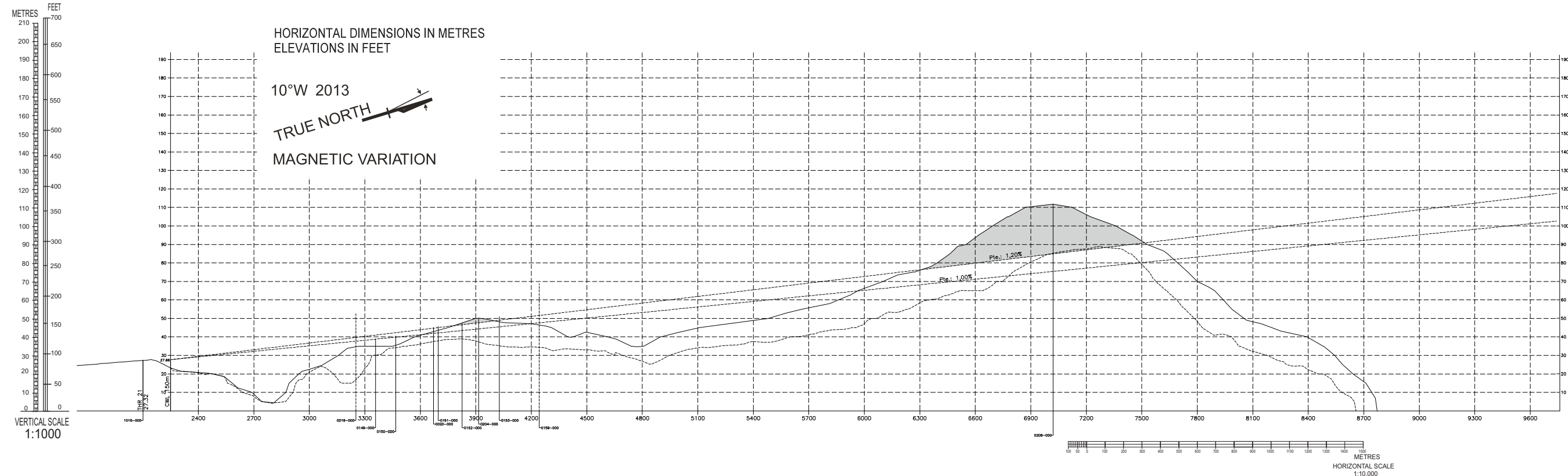

There are no Obstacles

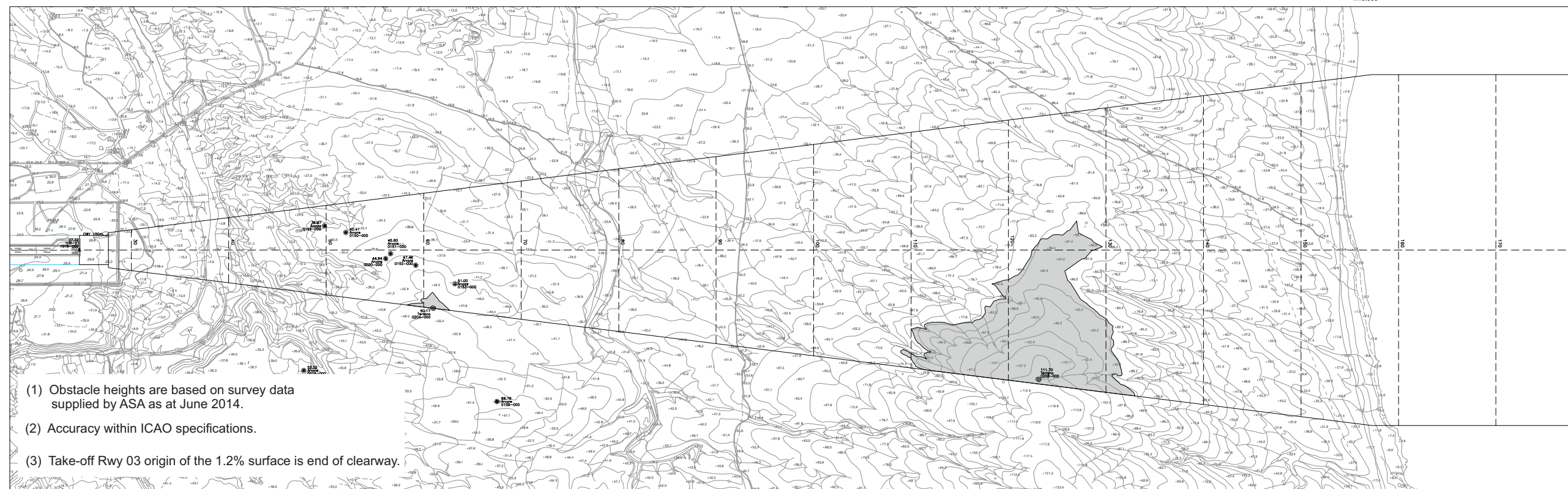

- (1) Obstacle heights are based on survey data supplied by ASA as at June 2014.
- (2) Accuracy within ICAO specifications.
- (3) Take-off Rwy 03 origin of the 1.2% surface is end of clearway.

There are no Obstacles

LEGENDA		DADOS TÉCNICOS	SCALES	RABIL AIRPORT - BOA VISTA ISLAND CAPE VERDE TYPE A CHART -RWY 03		AMENDMENT RECORD								
<ul style="list-style-type: none"> <li>--- EIXO DA PISTA PROLONGADO EM AMBOS OS SENTIDOS.</li> <li>0216-000 OBSTÁCULOS DENTRO DA SUPERFÍCIE.</li> <li>0214-000 OBSTÁCULOS FORA DA SUPERFÍCIE.</li> <li>--- PERFIL TERRENO PELO EIXO</li> <li>--- PERFIL TERRENO PELOS OBSTÁCULOS</li> <li>▨ TERRENO QUE SUPERA O 1,2% DE PENDENTE</li> </ul>	<ul style="list-style-type: none"> <li>▲ ÁRVORE, ARBUSTO.</li> <li>⊠ TORRE ELÉCTRICA, METALICA.</li> <li>⊠ ANTENA</li> <li>⊠ ANTENA SOBRE EDIFÍCIO</li> <li>⊙ POSTE, MASTILH.</li> <li>⊙ POSTE ILUMINAÇÃO</li> <li>▬ VEDAÇÃO</li> <li>■ EDIFÍCIO, BARRACÃO.</li> <li>⊙ TERRENO</li> <li>⊙ ESTRADA</li> <li>⊙ OUTROS OBSTÁCULOS</li> </ul>	<ul style="list-style-type: none"> <li>▲ RECTA V. GEODÉSICO, THR, ARP, ETC.</li> <li>⊠ NDI</li> <li>⊠ RVR</li> <li>⊠ LUZES APROXIMAÇÃO</li> <li>⊠ PAPI</li> <li>⊠ LOCALIZADOR ILS</li> <li>⊠ GLIDE SLOPE</li> <li>⊠ TORRE ILUMINAÇÃO</li> <li>⊙ DEPOSITO</li> <li>⊙ NDB</li> <li>⊠ AERODROMO</li> </ul>	<p>DATUM: WGS84 PROJEÇÃO: LAMBERT FUSO: CONVERGÊNCIA MERIDIANOS: 0°18'11,681" FATOR ESCALA PROJEÇÃO: 0,99990883 ALURAS: ORTOMÉTRICAS EQUIDISTANCIA CURVAS NIVEL: 5m</p> <p>NOTAS: Convergência de meridiano e fator de escala de projeção calculadas para o AIP do aeroporto.</p>	<p>H= 1 : 10.000 V= 1 : 1000</p>	<p>RWY 03 2100m TAKE-OFF RUN AVAILABLE (TORA) 2250m TAKE-OFF DISTANCE AVAILABLE (TODA) 2100m ACCELERATE STOP DISTANCE AVAILABLE (ASDA) 2100m LANDING DISTANCE AVAILABLE (LDA)</p>	<table border="1" style="width: 100%; border-collapse: collapse;"> <tr> <th colspan="2" style="text-align: center;">AMENDMENT RECORD</th> </tr> <tr> <td style="width: 50%;">No.</td> <td></td> </tr> <tr> <td>Date</td> <td></td> </tr> <tr> <td>Endorsed by</td> <td></td> </tr> </table>	AMENDMENT RECORD		No.		Date		Endorsed by	
AMENDMENT RECORD														
No.														
Date														
Endorsed by														

Obstacle Ref	Latitude	Longitude	Orthometric Hight (FT)	Orthometric Hight (M)
0004-007	16,0727089376	-22,5329954463	93,75224	28,583
0006-000	16,0727865361	-22,5320700057	199,03368	60,681
0007-000	16,0732127994	-22,5316942063	157,67616	48,072
0016-000	16,0734165509	-22,5334378312	74,87256	22,827
0019-000	16,0917243642	-22,5237789251	172,27216	52,522
0020-000	16,0935709933	-22,5252233072	147,40648	44,941
0029-026	16,0734632107	-22,5328784595	66,09856	20,152
0030-001	16,0735500715	-22,5331029365	70,638408	21,5361
0030-048	16,0735288870	-22,5325165237	79,25136	24,162
0031-000	16,0703471194	-22,5334759159	151,3556	46,145
0032-000	16,0235661866	-22,5443624783	1199,54848	365,716
0032-001	16,0236194990	-22,5430959699	1107,62976	337,692
0056-000	16,0605418338	-22,5353377221	293,478	89,475
0056-003	16,0611783624	-22,5348539091	262,4	80
0056-004	16,0605982814	-22,5351982028	291,07376	88,742
0056-005	16,0616444563	-22,5342434313	247,27592	75,389
0056-006	16,0618790917	-22,5343882656	237,31456	72,352
0056-008	16,0604039164	-22,5357313417	296,43	90,375
0057-002	16,0556187877	-22,5421675191	373,0672	113,74
0057-003	16,0557728770	-22,5419344467	360,8	110
0057-004	16,0602005312	-22,5416063511	330,1484	100,655
0057-005	16,0556430510	-22,5419714732	360,8	110
0060-067	16,0729106067	-22,5329382161	79,74664	24,313
0060-069	16,0730241219	-22,5331905409	74,97752	22,859
0084-000	16,0728895637	-22,5330213129	78,92992	24,064
0088-000	16,0732811047	-22,5316979879	150,94888	46,021
0149-000	16,0927505999	-22,5300686273	127,50016	38,872
0150-000	16,0930588682	-22,5258545003	132,5448	40,41
0151-000	16,0936723307	-22,5252807329	149,58112	45,604
0152-000	16,0940199058	-22,5249655407	155,65568	47,456
0153-000	16,0945564711	-22,5244637108	167,27344	50,998
0159-000	16,0946659452	-22,5223080619	225,5984	68,78
0199-000	16,0600859604	-22,5358030503	300,366	91,575
0201-000	16,0604402727	-22,5413720929	303,318	92,475
0204-000	16,0940913213	-22,5241682871	164,5576	50,17
0208-000	16,1114302205	-22,5159893080	366,376	111,7

TYPE A (OPERATING LIMITATIONS)

RABIL INTERNATIONAL AIRPORT - BOA VISTA

RWY 21

HORIZONTAL DIMENSIONS IN METRES  
ELEVATIONS IN FEET

10°W 2013

TRUE NORTH

MAGNETIC VARIATION

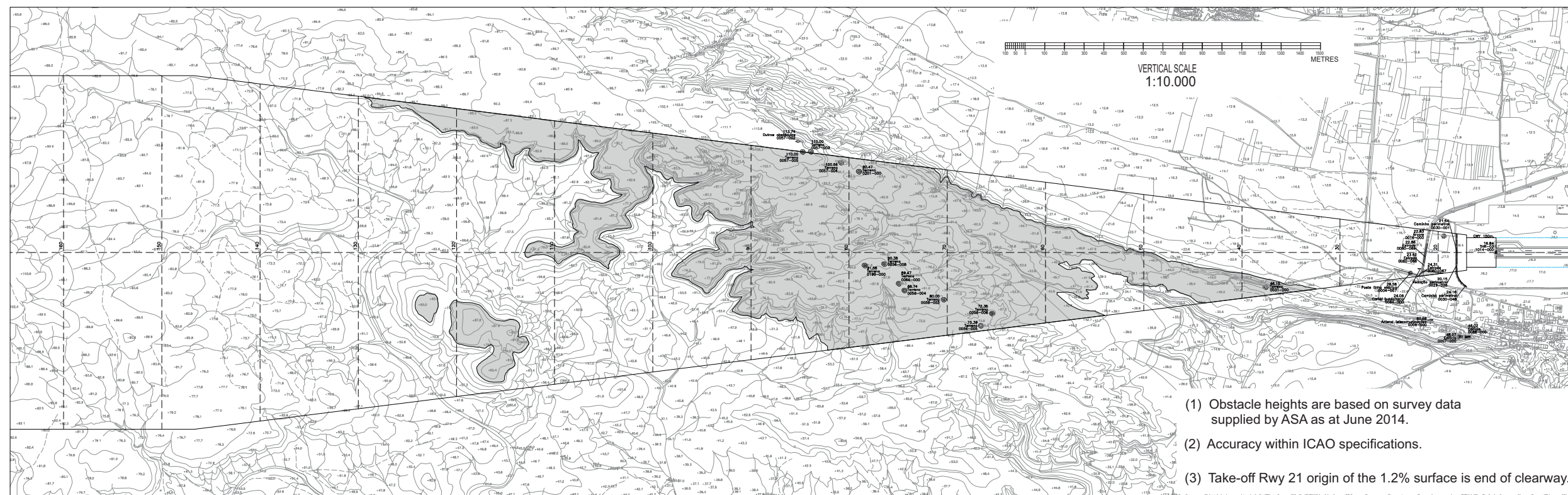
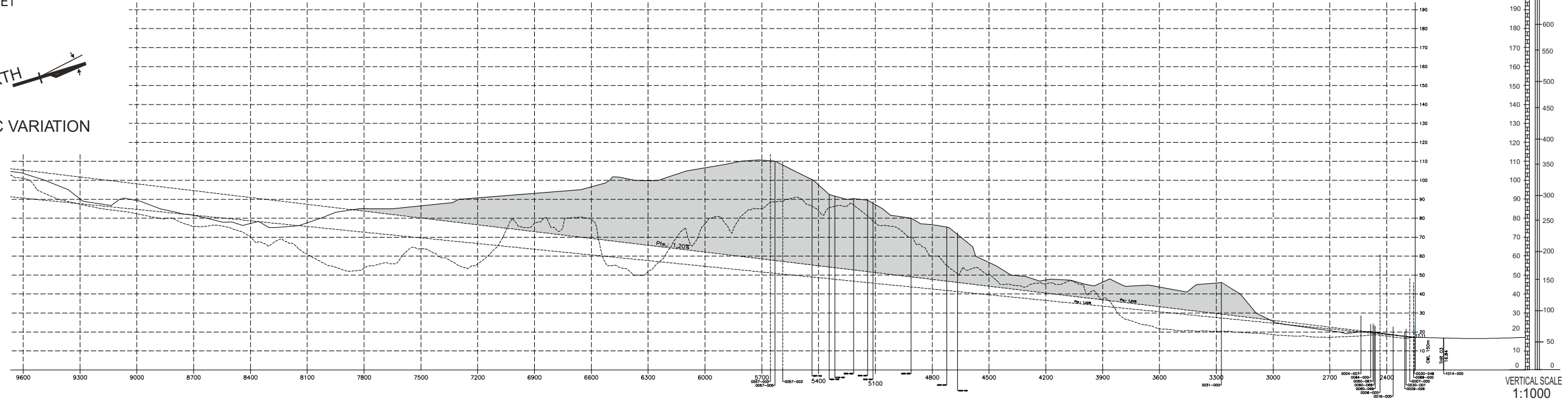

- (1) Obstacle heights are based on survey data supplied by ASA as at June 2014.
- (2) Accuracy within ICAO specifications.
- (3) Take-off Rwy 21 origin of the 1.2% surface is end of clearway.

LEGEND

--- EXO DA PISTA PROLONGADO EM AMBOS OS SENTIDOS.	▲ ARVORE, ARBUSTO.	▲ RCTA. V. GEODÉSICO, THR. ARP, ETC.
--- OBSTÁCULOS DENTRO DA SUPERFÍCIE.	⊠ TORRE ELÉCTRICA, METÁLICA.	⊠ WDI
--- OBSTÁCULOS FORA DA SUPERFÍCIE.	⊠ ANTENA	⊠ RVR
--- PERFIL TERRENO PELO EIXO	⊠ ANTENA SOBRE EDIFÍCIO	⊠ LUZES APROXIMAÇÃO
--- PERFIL TERRENO PELOS OBSTÁCULOS	⊠ POSTE, MÁSTIL	⊠ PAPI
--- TERRENO QUE SUPERA O 1,2% DE PENDENTE	⊠ POSTE ILUMINAÇÃO	⊠ LOCALIZADOR ILS
	⊠ VEDADO	⊠ GLIDE SLOPE
	⊠ EDIFÍCIO, BARRACÃO.	⊠ TORRE ILUMINAÇÃO
	⊠ TERRENO	⊠ DEPÓSITO
	⊠ ESTRADA	⊠ NOB
	⊠ OUTROS OBSTÁCULOS	⊠ AEROGERADOR

DADOS TÉCNICOS

DATUM: WGS84	H = 1 : 10.000
PROJEÇÃO: LAMBERT	V = 1 : 1000
FUSO: CONVERGÊNCIA MERIDIANOS: 0°18'11,681"	
FATOR ESCALA PROJEÇÃO: 0,99990883	
ALURAS: ORTOMÉTRICAS	
EQUIDISTÂNCIA CURVAS NÍVEL: 5m	
NOTAS: Convergência de meridianos e fator de escala da projeção calculados para o ARP do aeroporito.	

SCALES

RABIL AIRPORT - BOA VISTA ISLAND CAPE VERDE  
TYPE A CHART - RUNWAY 21

RWY 21	DECLARED DISTANCES
2100m	TAKE-OFF RUN AVAILABLE (TORA)
2250m	TAKE-OFF DISTANCE AVAILABLE (TODA)
2100m	ACCELERATE STOP DISTANCE AVAILABLE (ASDA)
2100m	LANDING DISTANCE AVAILABLE (LDA)

AMENDMENT RECORD

No.	
Date	
Endorsed by	

TYPE A (OPERATING LIMITATIONS)

RABIL INTERNATIONAL AIRPORT - BOA VISTA

RWY 21

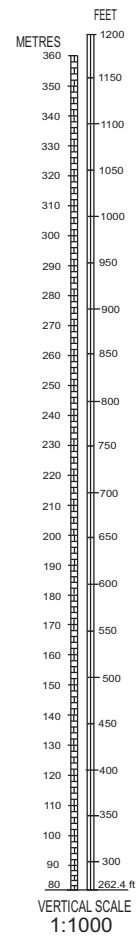

HORIZONTAL DIMENSIONS IN METRES  
ELEVATIONS IN FEET

10°W 2013  
TRUE NORTH  
MAGNETIC VARIATION

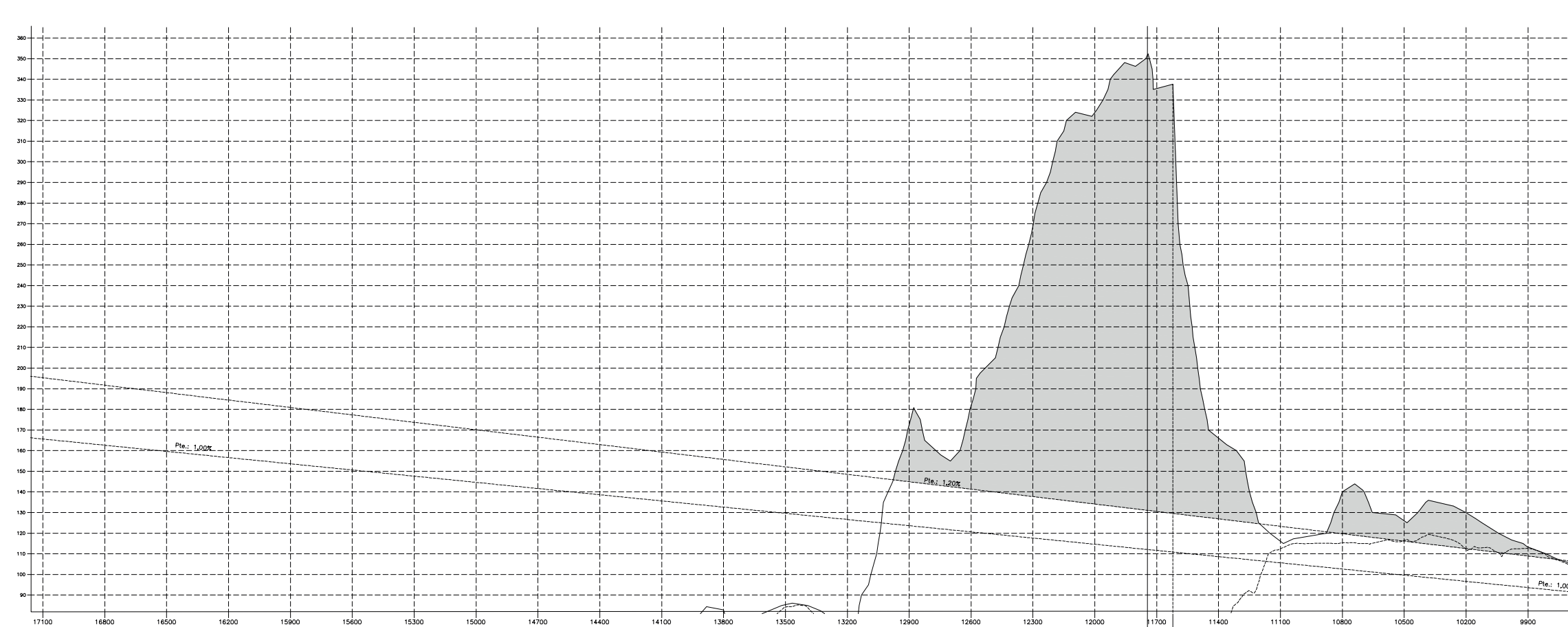

- (1) Obstacle heights are based on survey data supplied by ASA as at June 2014.
- (2) Accuracy within ICAO specifications.
- (3) Take-off Rwy 21 origin of the 1.2% surface is end of clearway.

LEGEND	DADOS TÉCNICOS	SCALES
<ul style="list-style-type: none"> <li>--- EIXO DA PISTA PROLONGADO EM AMBOS OS SENTIDOS.</li> <li>0216-000 OBSTÁCULOS DENTRO DA SUPERFÍCIE.</li> <li>0216-000 OBSTÁCULOS FORA DA SUPERFÍCIE.</li> <li>--- PERFIL TERRENO PELO EIXO</li> <li>--- PERFIL TERRENO PELOS OBSTÁCULOS</li> <li>TERRENO QUE SUPERA O 1,2% DE PENDENTE</li> </ul>	<ul style="list-style-type: none"> <li>▲ ÁRVORE, ARRUSTO.</li> <li>■ TORRE ELÉCTRICA, METAJUA.</li> <li>⊥ ANTENA</li> <li>⊥ ANTENA SOBRE EDIFÍCIO</li> <li>⊙ POSTE, MASTIL.</li> <li>⊙ POSTE ILUMINAÇÃO</li> <li>— VEDAÇÃO</li> <li>■ EDIFÍCIO, BARRIACA.</li> <li>⊙ TERRENO</li> <li>⊙ DEPÓSITO</li> <li>⊙ ESTRADA</li> <li>⊙ OUTROS OBSTÁCULOS</li> <li>▲ FICIA, V. GEODÉSICO, THR, APP, ETC.</li> <li>⊙ WCI</li> <li>⊙ RVR</li> <li>⊙ LUZES APROXIMAÇÃO</li> <li>⊙ PAPI</li> <li>⊙ LOCALIZADOR ILS</li> <li>⊙ GUIDE SLOPE</li> <li>⊙ TORRE ILUMINAÇÃO</li> <li>⊙ DEPOSITO</li> <li>⊙ WCI</li> <li>⊙ AERODIAGNÓSTICO</li> </ul>	<p>DATUM: WGS84 PROJEÇÃO: LAMBERT FUSO: CONVERGÊNCIA MERIDIANOS: 0°18'11,681" FATOR ESCALA PROJEÇÃO: 0,99990883 ALURAS: ORTOMÉTRICAS EQUIDISTÂNCIA CURVAS NIVEL: 5m</p> <p>NOTAS: Convergência de meridianos e fator de escala de projeção calculados para o AIP do aeroporto.</p> <p>H= 1 : 10.000 V= 1 : 1000</p>

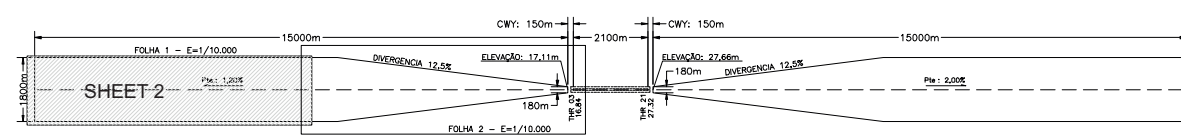

AMENDMENT RECORD	
No.	
Date	
Endorsed by	



**STANDARD DEPARTURE  
CHART INSTRUMENT  
(SID) - ICAO**

**AMILCAR CABRAL  
AIRPORT GVAC  
RWY 01**

TA: 7000'  
VAR: 10W  
APP - 126.400  
TWR - 119.700

TA: 7000'  
VAR: 10W  
APP - 126.400  
TWR - 118.900

**RABIL AIRPORT  
GVBA  
RWY 03**

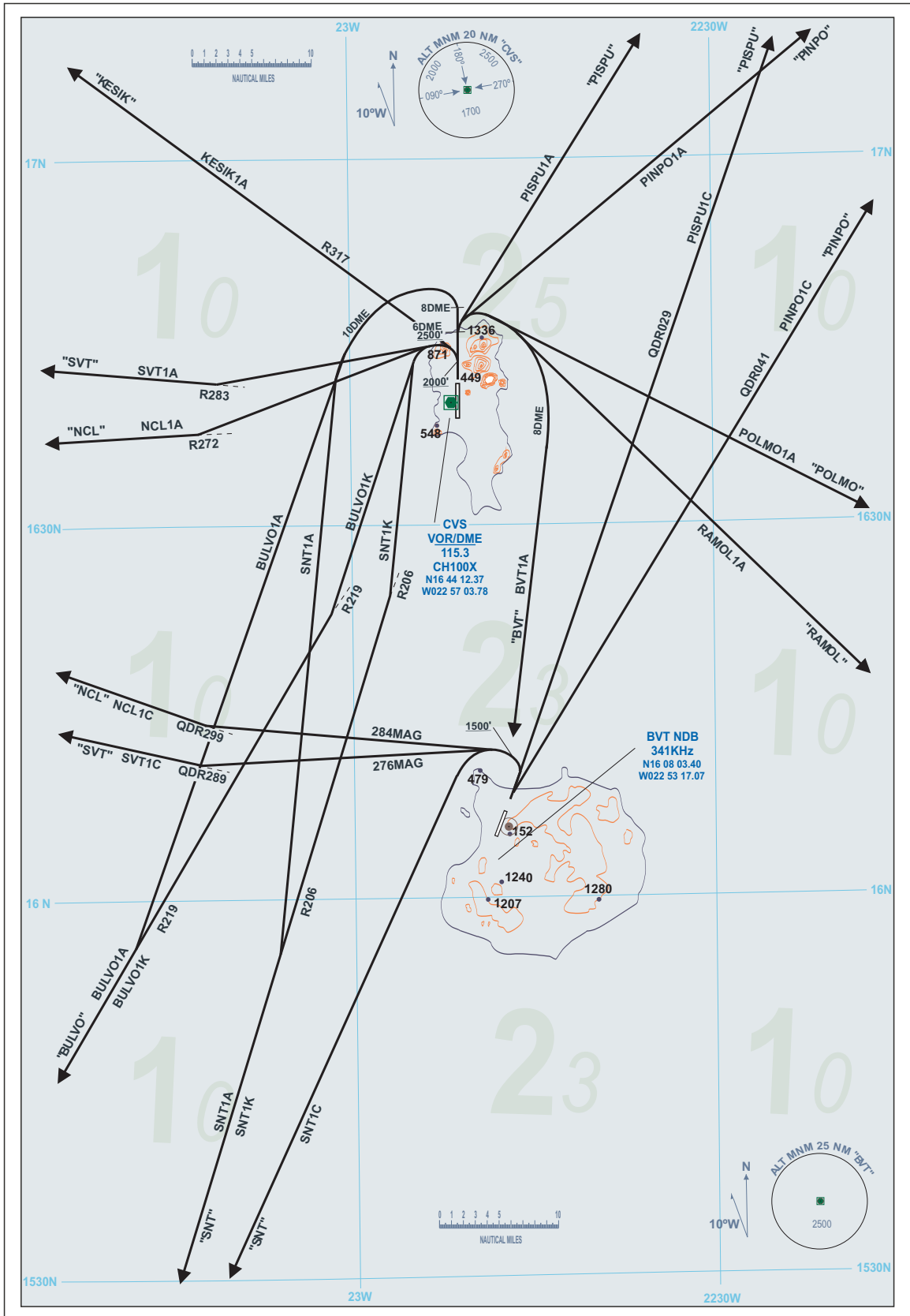

STANDARD DEPARTURE (SID)-ICAO DESCRIPTION	AMILCAR CABRAL AIRPORT GVAC RWY 01	RABIL AIRPORT GVAC RWY03
<u>GVAC RWY 01</u>		
<p><b>BULVO1A</b> : Climb on runway track till 8 DME/CVS. Turn left to BULVO (RDL219CVS). Remain beyond 10 DME CVS.</p> <p><b>BULVO1K</b> : Climb on runway track till passing 2000ft. Turn left to BULVO (RDL219CVS).</p> <p><b>BVT1A</b> : Climb on runway track till passing 2500ft and 6 DME/CVS. Turn right direct BVT NDB. Remain beyond 8 DME/CVS.</p> <p><b>KESIK1A</b> : Climb on runway track till passing 2000ft. Turn left to KESIK (RDL317CVS) .</p> <p><b>NCL1A</b> : Climb on runway track till passing 2000ft. Turn left to intercept and follow RDL272CVS to NCL NDB. MSA 6500ft.</p> <p><b>PISPU1A</b> : Climb on runway track till passing 2500ft and 6 DME/CVS. Turn right to PISPU (RDL040CVS).</p> <p><b>PINPO1A</b> : Climb on runway track till passing 2500ft and 6 DME/CVS. Turn right to PINPO (RDL057CVS).</p> <p><b>POLMO1A</b> : Climb on runway track till passing 2500ft and 6 DME/CVS. Turn right to POLMO (RDL120CVS).</p> <p><b>RAMOL1A</b> : Climb on runway track till passing 2500ft and 6 DME/CVS. Turn right to RAMOL (RDL137CVS). Remain beyond 8 DME CVS.</p> <p><b>SNT1A</b> : Climb on runway track till 8 DME/CVS. Turn left to intercept and follow RDL206CVS to SNT VOR. Remain beyond 10 DME CVS.</p> <p><b>SNT1K</b> : Climb on runway track till passing 2000ft. Turn left to intercept and follow RDL206CVS to SNT VOR. Remain beyond 3 DME CVS.</p> <p><b>SVT1A</b> : Climb on runway track till passing 2000ft. Turn left to intercept and follow RDL283CVS to SVT NDB. MSA 4600ft.</p>		
<u>GVAC RWY 19</u>		
<p><b>BULVO1B</b> : After departure follow R191CVS till 4 DME CVS. Turn right to follow RDL219CVS to BULVO.</p> <p><b>KESIK1B</b> : After departure follow R191CVS till 6 DME CVS. Turn right to KESIK (RDL317CVS).. Remain beyond 8 DME/CVS.</p> <p><b>NCL1B</b> : After departure follow R191CVS till passing 2000ft or 4 DME CVS. Turn right to intercept and follow RDL272CVS to NCL NDB.</p> <p><b>PISPU1B</b> : After departure follow R191CVS till 5 DME CVS. Turn left to intercept and follow arc 7 DME CVS. Crossing R137 follow track 029MAG to intercept and follow RDL040CVS to PISPU.</p> <p><b>PINPO1B</b> : After departure follow R191CVS till 5 DME CVS. Turn left to intercept and follow arc 7 DME CVS. Crossing R137 follow track 044MAG to intercept and follow RDL057CVS to PINPO.</p> <p><b>POLMO1B</b> : After departure follow R191CVS till 5 DME CVS. Turn left to intercept and follow arc 7 DME CVS. Crossing R169 follow track 099MAG to intercept and follow RDL120CVS to POLMO</p> <p><b>RAMOL1B</b> : After departure follow R191CVS till 5 DME CVS. Turn left to intercept and follow arc 7 DME CVS. Crossing R169 follow track 099MAG to intercept and follow RDL137CVS to RAMOL.</p> <p><b>SNT1B</b> : After departure follow R191CVS till 4DME CVS. Turn right to follow RDL206CVS to SNT VOR.</p> <p><b>SVT1B</b> : After departure follow R191CVS till passing 2000ft or 4 DME CVS. Turn right to intercept and follow RDL283CVS to SVT NDB.</p>		
<u>GVBA RWY 03</u>		
<p><b>NCL1C</b> : Climb on runway heading till passing 1500ft. Turn left to follow track 284MAG to join QDR299BVT to NCL NDB. MSA over NCL6500ft.</p> <p><b>PISPU1C</b> : After departure join QDR029BVT to PISPU (RDL040CVS/80DME).</p> <p><b>PINPO1C</b> : After departure join QDR041BVT to PINPO (RDL057CVS/80DME).</p> <p><b>SNT1C</b> : Climb on runway heading till passing 1500ft. Turn left direct SNT VOR (RDL036SNT).</p> <p><b>SVT1C</b> : Climb on runway heading till passing 1500ft. Turn left to follow track 276MAG to join QDR289BVT to SISAU (N162116W0242011/QDR200NCL) then direct SVT NDB on QDR135SVT. MSA 4600ft.</p>		
<u>GVBA RWY 21</u>		
<p><b>NCL1D</b> : After departure turn right to join QDR299BVT to NCL NDB. MSA over NCL is 6500ft.</p> <p><b>PISPU1D</b> : Climb on runway heading till passing 1500ft. Turn right to follow track 044MAG to join QDR029BVT to PISPU(RDL040CVS/80DME).</p> <p><b>PINPO1D</b> : Climb on runway heading till passing 1500ft. Turn right to follow track 049MAG to join QDR041BVT to PINPO (RDL057CVS/80DME).</p> <p><b>SNT1D</b> : After departure follow QDR216BVT to SNT VOR (RDL037SNT).</p> <p><b>SVT1D</b> : After departure turn right to join QDR289BVT to SISAU (N162116 W0242011 / QDR200NCL) then direct SVT NDB on QDR135SVT. MSA 4600ft.</p>		

STANDARD INSTRUMENT  
RNAV(GNSS)  
DEPARTURE CHART  
(SID)- ICAO

AD ELEV 91 FT

VAR 10° W  
TA 7000

APP 126.400  
TWR 118.900

RABIL / Arlides Pereira Intl  
BOA VISTA  
RWY 03

BA3641J, BA3661J, BA3671J, CVS1J, DENER1J, EDIPA1J, EVKAS1J, KESIK1J, LININ1J, MOPAC1J, NEMDO1J, NINAU1J, PINPO1J, PISPU1J, POLMO1J, RAMOL1J, SISAU1J, SNT1J, SONVA1J

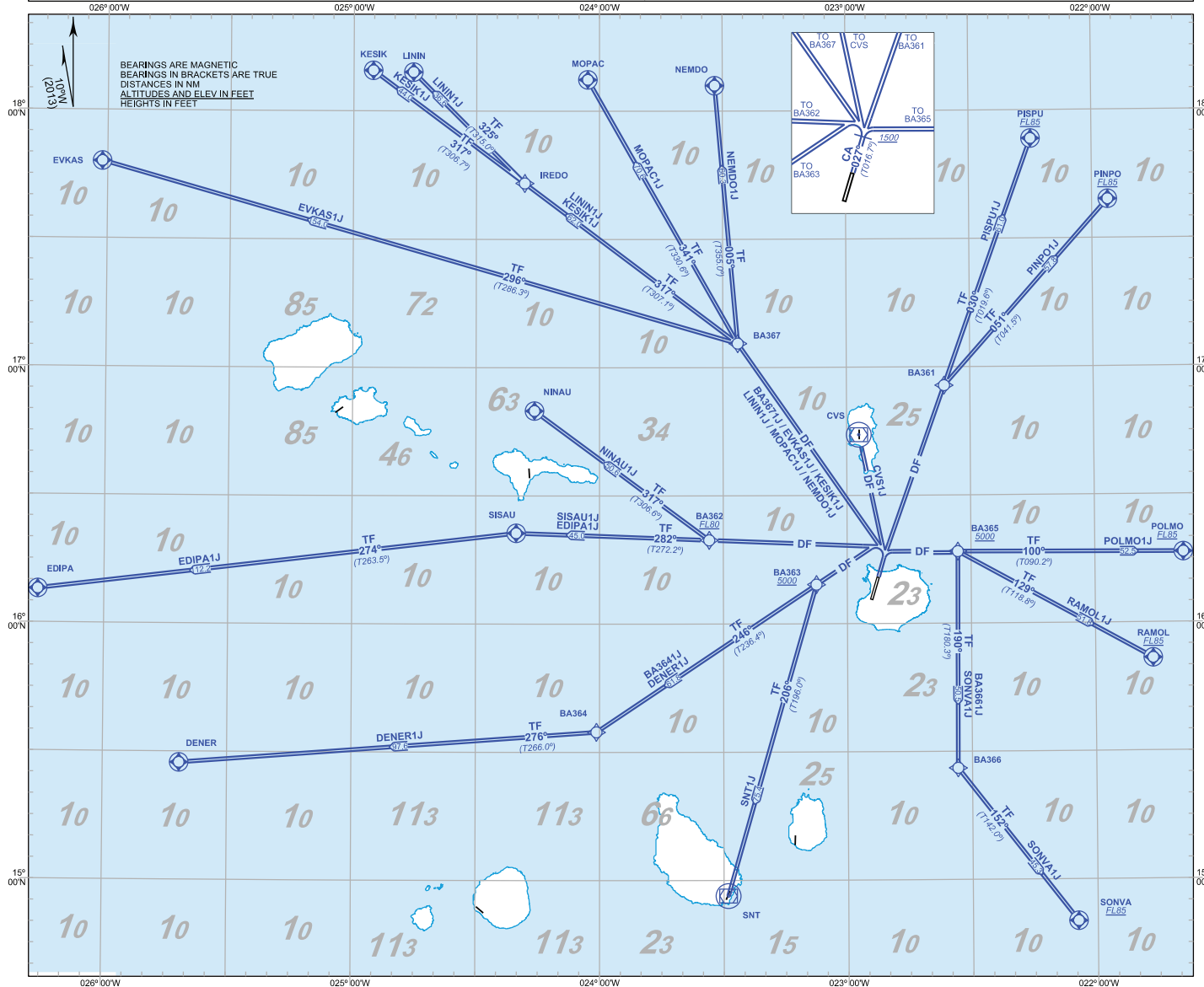

WAYPOINTS:

BA361:	16°55'40.3200"N	022°36'16.8000"W
BA362:	16°19'36.0000"N	023°33'24.3700"W
BA363:	16°09'09.6900"N	023°07'27.4200"W
BA364:	15°34'41.8400"N	024°00'44.2000"W
BA365:	16°16'49.5400"N	022°33'11.1500"W
BA366:	15°26'06.9500"N	022°33'25.1200"W
BA367:	17°05'36.9200"N	023°26'22.7800"W
CVS VOR/DME:	16°44'12.0200"N	022°57'03.0600"W
DENER:	15°27'24.0000"N	025°41'32.0000"W
EDIPA:	16°07'55.0000"N	026°16'00.0000"W
EVKAS:	17°48'03.0000"N	026°01'16.0000"W
IREDO:	17°43'06.0000"N	024°18'12.0000"W
KESIK:	18°09'28.0000"N	024°55'13.0000"W
LININ:	18°09'05.0000"N	024°45'24.0000"W
MOPAC:	18°07'20.0000"N	024°02'50.0000"W
NEMDO:	18°05'57.0000"N	023°31'54.0000"W
NINAU:	16°49'52.0000"N	024°15'47.0000"W
PINPO:	17°39'05.0000"N	021°56'08.0000"W
PISPU:	17°53'20.0000"N	022°14'53.0000"W
POLMO:	16°16'29.0000"N	021°38'34.0000"W
RAMOL:	15°51'42.0000"N	021°46'06.0000"W
SISAU:	16°21'16.0000"N	024°20'11.0000"W
SNT VOR/DME:	14°56'20.7400"N	023°28'55.6400"W
SONVA:	14°50'14.0000"N	022°04'38.0000"W

RNP1 APPROVAL REQUIRED.

IAS MAX 250 kt to reach FL100 or below

SCALE 1:1 700 000

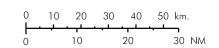

**RNAV (GNSS) SID RWY 03 coding table**

DESCRIPTION

TEXTUAL DESCRIPTION	ABBREVIATED DESCRIPTION	Expected Path Terminator Coding	Fly-Over Required
<b>NOTES APLICABLE TO ALL SID:</b>			
<ul style="list-style-type: none"> <li>- RNAV 1 APPROVAL REQUIRED</li> <li>- REQUIRED GNSS</li> <li>- IAS MAX 250 kt TO REACH FL100</li> </ul>			
<b>SID BA364 1J RNAV1 (GNSS)</b>			
Climb on course 027°, at or above 1500 ft, turn left. Direct to BA363 at or above 5000 ft. To BA364.	[M027°; A1500+; L] - BA363 [A5000+] - BA364	CA DF TF	- - -
<b>SID BA366 1J RNAV1 (GNSS)</b>			
Climb on course 027°, at or above 1500 ft, turn right. Direct to BA365 at or above 5000 ft, turn right. To BA366.	[M027°; A1500+; R] - BA365 [A5000+; R] - BA366	CA DF TF	- - -
<b>SID BA367 1J RNAV1 (GNSS)</b>			
Climb on course 027°, at or above 1500 ft, turn left. Direct to BA367.	[M027°; A1500+; L] - BA367	CA DF	- -
<b>SID CVS 1J RNAV1 (GNSS)</b>			
Climb on course 027°, at or above 1500 ft, turn left. Direct to <u>CVS</u> .	[M027°; A1500+; L] - <u>CVS</u>	CA DF	- Y
<b>SID DENER 1J RNAV1 (GNSS)</b>			
Climb on course 027°, at or above 1500 ft, turn left. Direct to BA363 at or above 5000 ft. To BA364, turn right. To <u>DENER</u>	[M027°; A1500+; L] - BA363 [A5000+] - BA364 [R] - DENER	CA DF TF TF	- - - Y
<b>SID EDIPA 1J RNAV1 (GNSS)</b>			
Climb on course 027°, at or above 1500 ft, turn left. Direct to BA362, at or above FL80. To SISAU, turn left. To <u>EDIPA</u> .	[M027°; A1500+; L] - BA362 [F80+] - SISAU [L] - <u>EDIPA</u>	CA DF TF TF	- - - Y
<b>SID EVKAS 1J RNAV1 (GNSS)</b>			
Climb on course 027°, at or above 1500 ft, turn left. Direct to BA367, turn left. To <u>EVKAS</u>	[M027°; A1500+; L] - BA367 [L] - <u>EVKAS</u>	CA DF TF	- - Y
<b>SID KESIK 1J RNAV1 (GNSS)</b>			
Climb on course 027°, at or above 1500 ft, turn left. Direct to BA367, turn left. To IREDO. To <u>KESIK</u> .	[M027°; A1500+; L] - BA367 [L] - IREDO - <u>KESIK</u>	CA DF TF TF	- - - Y
<b>SID LININ 1J RNAV1 (GNSS)</b>			
Climb on course 027°, at or above 1500 ft, turn left. Direct to BA367, turn left. To IREDO, turn right. To <u>LININ</u> .	[M027°; A1500+; L] - BA367 [L] - IREDO [R] - <u>LININ</u>	CA DF TF TF	- - - Y

TEXTUAL DESCRIPTION	ABBREVIATED DESCRIPTION	Expected Path Terminator Coding	Fly-Over Required
<b>SID MOPAC 1J RNAV1 (GNSS)</b>			
Climb on course 027°, at or above 1500 ft, turn left. Direct to BA367, turn right. To <u>MOPAC</u>	[M027°; A1500+; L] - BA367 [R] - <u>MOPAC</u>	CA DF TF	- - Y
<b>SID NEMDO 1J RNAV1 (GNSS)</b>			
Climb on course 027°, at or above 1500 ft, turn left. Direct to BA367, turn right. To <u>NEMDO</u>	[M027°; A1500+; L] - BA367 [R] - <u>NEMDO</u>	CA DF TF	- - Y
<b>SID NINAU 1J RNAV1 (GNSS)</b>			
Climb on course 027°, at or above 1500 ft, turn left. Direct to BA362 at or above FL80, turn right. To <u>NINAU</u> .	[M027°; A1500+; L] - BA362 [F080+; R] - <u>NINAU</u>	CA DF TF	- - Y
<b>SID PINPO 1J RNAV1 (GNSS)</b>			
Climb on course 027°, at or above 1500 ft. Direct to BA361, turn right. To <u>PINPO</u> at or above FL85.	[M027°; A1500+] - BA361 [R] - <u>PINPO</u> [F085+]	CA DF TF	- - Y
<b>SID PISPU 1J RNAV1 (GNSS)</b>			
Climb on course 027°, at or above 1500 ft. Direct to BA361. To <u>PISPU</u> at or above FL85.	[M027°; A1500+; L] - BA361 - <u>PISPU</u> [F085+]	CA DF TF	- - Y
<b>SID POLMO 1J RNAV1 (GNSS)</b>			
Climb on course 027°, at or above 1500 ft, turn right. Direct to BA365, at or above 5000 ft. To <u>POLMO</u> , at or above FL85.	[M027°; A1500+; L] - BA365 [A5000+] - <u>POLMO</u> [F085+]	CA DF TF	- - Y
<b>SID RAMOL 1J RNAV1 (GNSS)</b>			
Climb on course 027°, at or above 1500 ft, turn right. Direct to BA365, at or above 5000 ft, turn right. To <u>RAMOL</u> , at or above FL85.	[M027°; A1500+; L] - BA365 [A5000+; R] - <u>RAMOL</u> [F085+]	CA DF TF	- - Y
<b>SID SISAU 1J RNAV1 (GNSS)</b>			
Climb on course 027°, at or above 1500 ft, turn left. Direct to BA362, at or above FL80. To SISAU.	[M027°; A1500+; L] - BA362 [F80+] - SISAU	CA DF TF	- - -
<b>SID SNT 1J RNAV1 (GNSS)</b>			
Climb on course 027°, at or above 1500 ft, turn left. Direct to BA363 at or above 5000 ft, turn left. To <u>SNT</u>	[M027°; A1500+; L] - BA363 [A5000+; L] - <u>SNT</u>	CA DF TF	- - Y
<b>SID SONVA 1J RNAV1 (GNSS)</b>			
Climb on course 027°, at or above 1500 ft, turn right. Direct to BA365 at or above 5000 ft, turn right. To BA366, turn left. To <u>SONVA</u> , at or above FL85.	[M027°; A1500+; R] - BA365 [A5000+; R] - BA366 [L] - <u>SONVA</u> [F085+]	CA DF TF TF	- - - Y

**STANDARD DEPARTURE  
CHART INSTRUMENT  
(SID) - ICAO**

**AMILCAR CABRAL  
AIRPORT GVAC  
RWY 19**

TA: 7000'  
VAR: 10W

APP - 126.400  
TWR - 119.700

TA: 7000'  
VAR: 10W

APP - 126.400  
TWR - 118.900

**RABIL AIRPORT  
GVBA  
RWY 21**

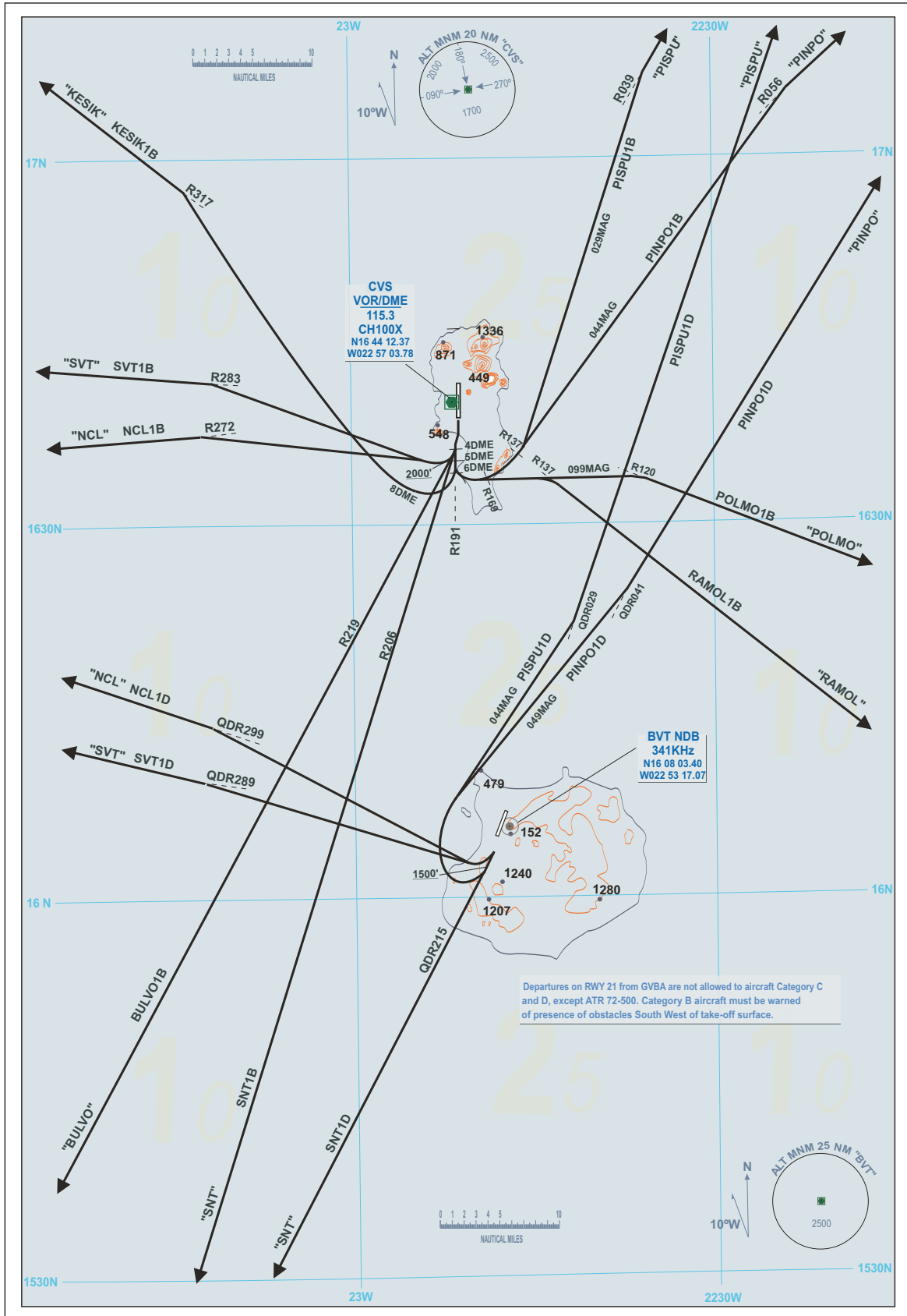

STANDARD INSTRUMENT  
RNAV(GNSS)  
DEPARTURE CHART  
(SID)- ICAO

AD ELEV 91 FT

VAR 10° W  
TA 7000

APP 126.400  
TWR 118.900

RABIL / Aristides Pereira Intl  
BOA VISTA  
RWY 21

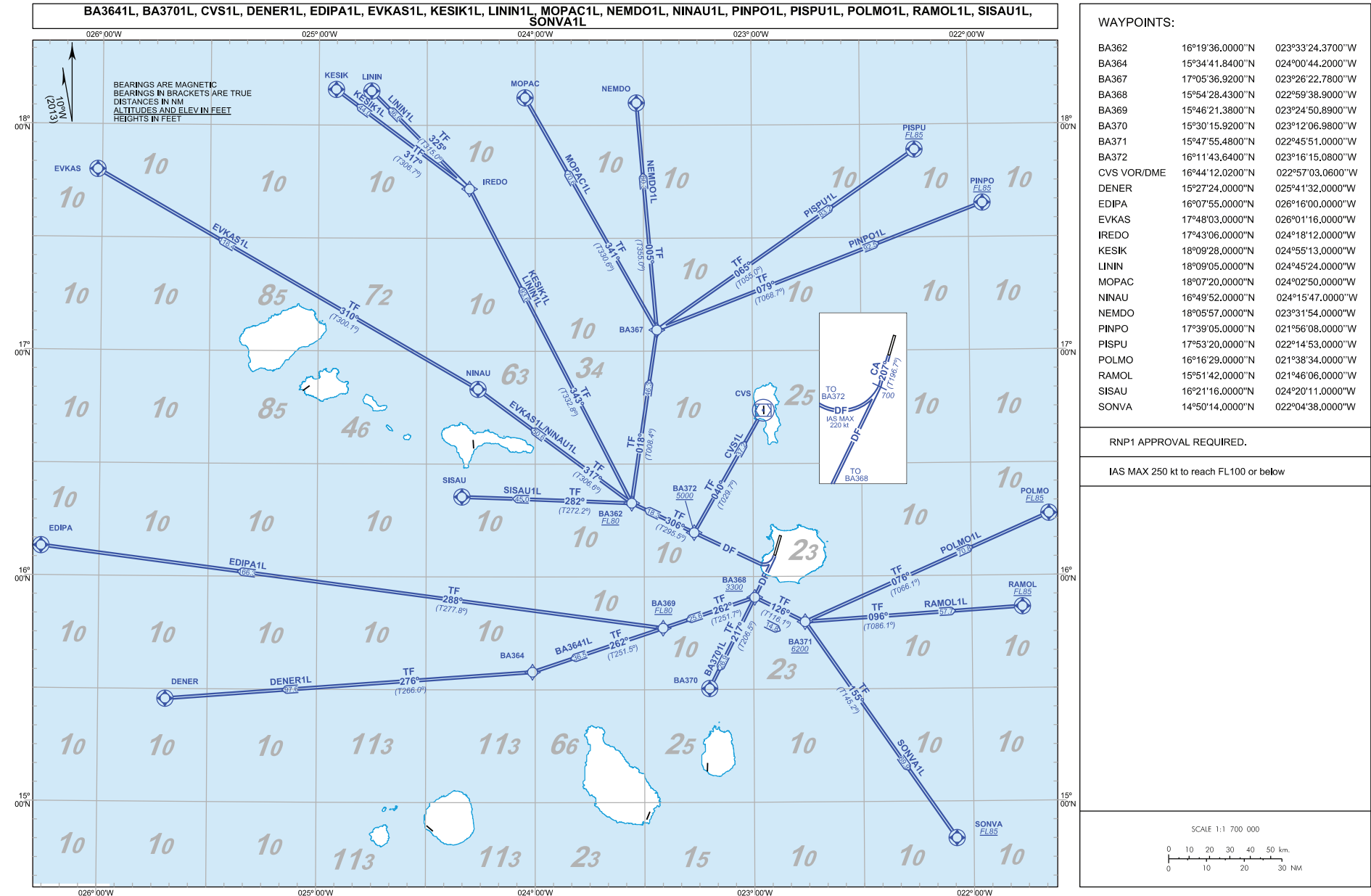

STANDARD INSTRUMENT  
RNAV(GNSS)  
DEPARTURE CHART  
(SID)- ICAO

AD ELEV 91 FT

RABIL / Aristides Pereira Intl  
BOA VISTA  
RWY 21

DESCRIPTION

TEXTUAL DESCRIPTION	ABBREVIATED DESCRIPTION	Expected Path Terminator Coding	Fly-Over Required
<b>NOTES APPLICABLE TO ALL SID:</b> - RNAV 1 APPROVAL REQUIRED - REQUIRED GNSS - IAS MAX 250 kt TO REACH FL100			
<b>SID BA364 1L RNAV1 (GNSS)</b>			
Climb on course 207° at or above 700 ft. Direct to BA368 at or above 3300 ft, turn right. To BA369 at or above FL80. To BA364.	[M207°; A700+] - BA368 [A3300+; R]- BA369 [F080+]- BA364	CA DF TF TF	- - - -
<b>SID BA370 1L RNAV1 (GNSS)</b>			
Climb on course 207° at or above 700 ft. Direct to BA368 at or above 3300 ft. To BA370.	[M207°; A700+] - BA368 [A3300+; R]- BA370	CA DF TF	- - Y
<b>SID CVS 1L RNAV1 (GNSS)</b>			
Climb on course 207° at or above 700 ft, turn right. Direct to BA372 at or above 5000 ft, turn right. To CVS.	[M207°; A700+] - BA372 [A5000+; R]- CVS	CA DF TF	- - Y
<b>SID DENER 1L RNAV1 (GNSS)</b>			
Climb on course 207° at or above 700 ft. Direct to BA368 at or above 3300 ft, turn right. To BA369 at or above FL80. To BA364, turn right. To DENER.	[M207°; A700+] - BA368 [A3300+; R]- BA369 [F080+]- BA364 [R]- DENER	CA DF TF TF TF	- - - - Y
<b>SID EDIPA 1L RNAV1 (GNSS)</b>			
Climb on course 207° at or above 700 ft. Direct to BA368 at or above 3300 ft, turn right. To BA369 at or above FL80, turn right. To EDIPA.	[M207°; A700+] - BA368 [A3300+; R]- BA369 [F080+; R]- EDIPA	CA DF TF TF	- - - Y
<b>SID EVKAS 1L RNAV1 (GNSS)</b>			
Climb on course 207° at or above 700 ft, turn right, maximum speed 220 kt. Direct to BA372 at or above 5000 ft. To BA362 at or above FL80, turn right. To NINAU, turn left. To EVKAS.	[M207°; A700+; R; 1<220]- BA372 [A5000+] - BA362 [F080+; R]- NINAU [L]- EVKAS	CA DF TF TF TF	- - - - Y
<b>SID KESIK 1L RNAV1 (GNSS)</b>			
Climb on course 207° at or above 700 ft, turn right, maximum speed 220 kt. Direct to BA372 at or above 5000 ft. To BA362 at or above FL80, turn right. To IREDO, turn left. To KESIK.	[M207°; A700+; R; K220]- BA372 [A5000+] - BA362 [F080+; R]- IREDO [L]- KESIK	CA DF TF TF TF	- - - - Y
<b>SID LININ 1L RNAV1 (GNSS)</b>			
Climb on course 207° at or above 700 ft, turn right, maximum speed 220 kt. Direct to BA372 at or above 5000 ft. To BA362 at or above FL80, turn right. To IREDO, turn left. To LININ.	[M207°; A700+; R; K220]- BA372 [A5000+] - BA362 [F080+; R]- IREDO [L]- LININ	CA DF TF TF TF	- - - - Y
<b>SID MOPAC 1L RNAV1 (GNSS)</b>			
Climb on course 207° at or above 700 ft, turn right, maximum speed 220 kt. Direct to BA372 at or above 5000 ft. To BA362 at or above FL80, turn right. To BA367, turn left. To MOPAC.	[M207°; A700+; R; K220]- BA372 [A5000+] - BA362 [F080+; R]- BA367 [L]- MOPAC	CA DF TF TF TF	- - - - Y

<b>SID NEMDO 1L RNAV1 (GNSS)</b>			
Climb on course 207° at or above 700 ft, turn right. Direct to BA372 at or above 5000 ft. To BA362 at or above FL80, turn right. To BA367, turn left. To NEMDO.	[M207°; A700+] - BA372 [A5000+] - BA362 [F080+; R]- BA367 [L]- NEMDO	CA DF TF TF TF	- - - - Y
<b>SID PINPO 1L RNAV1 (GNSS)</b>			
Climb on course 207° at or above 700 ft, turn right, maximum speed 220 kt. Direct to BA372 at or above 5000 ft. To BA362 at or above FL80, turn right. To BA367, turn right. To PINPO at or above FL85.	[M207°; A700+; R; K220]- BA372 [A5000+] - BA362 [F080+; R]- BA367 [R]- PINPO [F085+]	CA DF TF TF TF	- - - - Y
<b>SID PISPU 1L RNAV1 (GNSS)</b>			
Climb on course 207° at or above 700 ft, turn right, maximum speed 220 kt. Direct to BA372 at or above 5000 ft. To BA362 at or above FL80, turn right. To BA367, turn right. To PISPU at or above FL85.	[M207°; A700+; R; K220]- BA372 [A5000+] - BA362 [F080+; R]- BA367 [R]- PISPU [F085+]	CA DF TF TF TF	- - - - Y
<b>SID NINAU 1L RNAV (GNSS)</b>			
Climb on course 207° at or above 700 ft, turn right, maximum speed 220 kt. Direct to BA372 at or above 5000 ft. To BA362 at or above FL80, turn right. To NINAU.	[M207°; A700+; R; K220]- BA372 [A5000+] - BA362 [F080+; R]- NINAU	CA DF TF TF TF	- - - - Y
<b>SID POLMO 1L RNAV (GNSS)</b>			
Climb on course 207° at or above 700 ft. Direct to BA368 at or above 3300 ft, turn left. To BA371 at or above 6200 ft, turn left. To POLMO at or above FL85.	[M207°; A700+] - BA368 [A3300+; L]- BA371 [A6200+; L]- POLMO [F085+]	CA DF TF TF TF	- - - - Y
<b>SID RAMOL 1L RNAV (GNSS)</b>			
Climb on course 207° at or above 700 ft. Direct to BA368 at or above 3300 ft, turn left. To BA371 at or above 6200 ft, turn left. To RAMOL at or above FL85.	[M207°; A700+] - BA368 [A3300+; L]- BA371 [A6200+; L]- RAMOL [F085+]	CA DF TF TF TF	- - - - Y
<b>SID SISAU 1L RNAV (GNSS)</b>			
Climb on course 207° at or above 700 ft, turn right, maximum speed 220 kt. Direct to BA372 at or above 5000 ft. To BA362 at or above FL80, turn left. To SISAU.	[M207°; A700+; R; K220]- BA372 [A5000+] - BA362 [F080+; L]- SISAU	CA DF TF TF TF	- - - - Y
<b>SID SONVA 1L RNAV (GNSS)</b>			
Climb on course 207° at or above 700 ft. Direct to BA368 at or above 3300 ft, turn left. To BA371 at or above 6200 ft, turn right. To SONVA.	[M207°; A700+]- BA368 [A3300+; L]- BA371 [A6200+; R]- SONVA	CA DF TF TF TF	- - - - Y

STANDARD INSTRUMENT  
RNAV(GNSS)  
ARRIVAL CHART  
(STAR)- ICAO

AD ELEV 91 FT

VAR 10° W  
TA 7000

APP 126.400  
TWR 118.900

RABIL / Aristides Pereira Intl  
BOA VISTA  
RWY 03

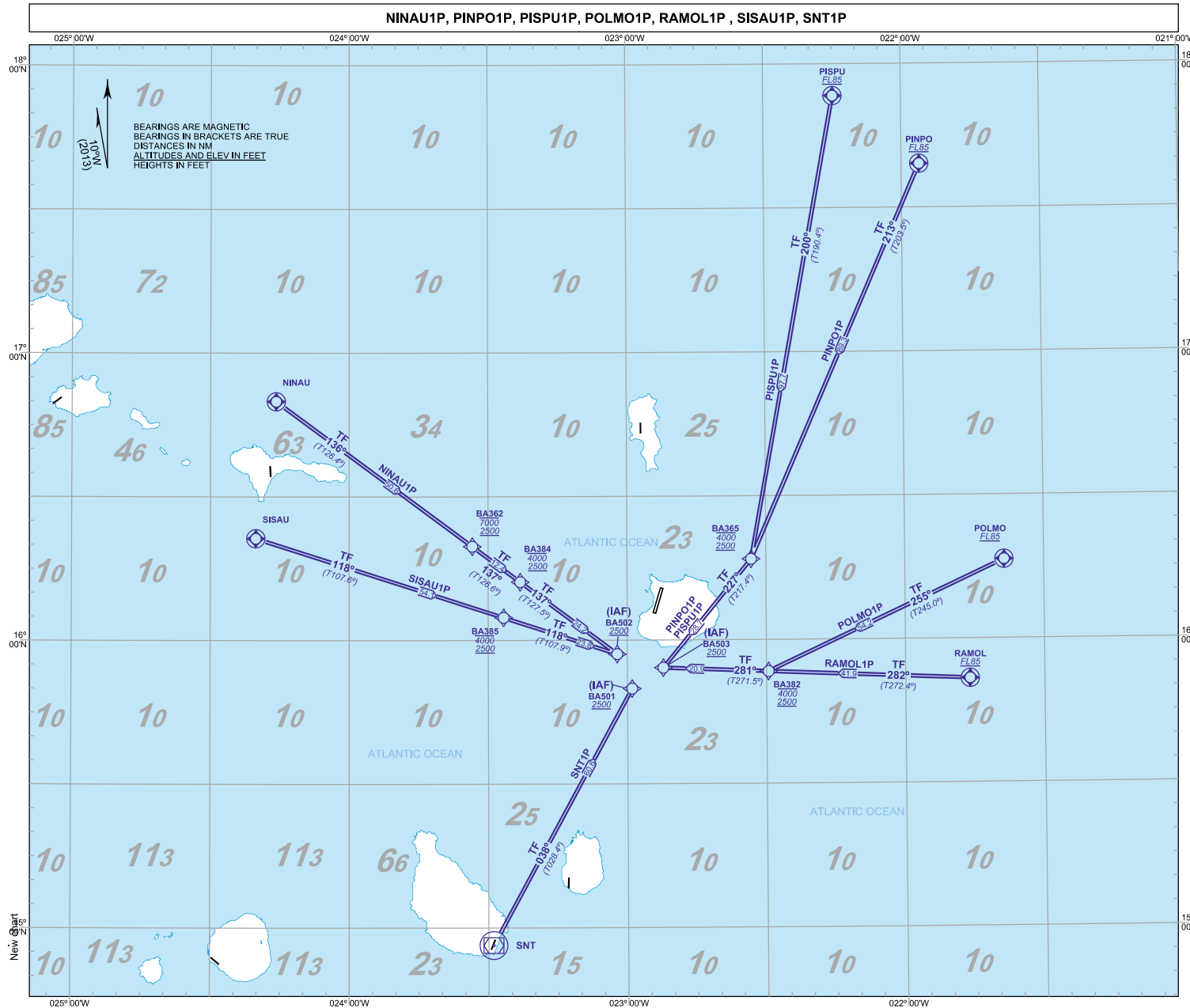

WAYPOINTS:

BA362:	16°19'36.0000"N	023°33'24.3700"W
BA365:	16°16'49.5400"N	022°33'11.1500"W
BA382:	15°53'23.3500"N	022°29'33.5500"W
BA384:	16°12'10.4200"N	023°23'04.6700"W
BA385:	16°04'44.5300"N	023°26'39.4700"W
BA501:	15°49'52.6801"N	022°58'59.8166"W
BA502:	15°57'22.6633"N	023°03'10.7296"W
BA503:	15°53'55.2192"N	022°51'14.9319"W
NINAU:	16°49'52.0000"N	024°15'47.0000"W
PINPO:	17°39'05.0000"N	021°56'08.0000"W
PISPU:	17°53'20.0000"N	022°14'53.0000"W
POLMO:	16°16'29.0000"N	021°38'34.0000"W
RAMOL:	5°51'42.0000"N	021°46'06.0000"W
SISAU:	16°21'16.0000"N	024°20'11.0000"W
SNT DVOR/DME:	14°56'20.7400"N	023°28'55.6400"W

RNAV1 APPROVAL REQUIRED.

IAS MAX 250 kt to reach FL100 or below



STANDARD INSTRUMENT  
RNAV(GNSS)  
ARRIVAL CHART  
(STAR)- ICAO

RABIL 7 Anstides Pereira Intl  
BOA VISTA  
RWY 03

**DESCRIPTION**

TEXTUAL DESCRIPTION	ABBREVIATED DESCRIPTION	Expected Path Terminator Coding	Fly-Over Required
<p>NOTES APLICABLE TO ALL SID:</p> <ul style="list-style-type: none"> <li>- RNAV 1 APPROVAL REQUIRED</li> <li>- REQUIRED GNSS</li> <li>- IAS MAX 250 kt BELOW FL100</li> </ul>			
<b>STAR NINAU 1P RNAV1 (GNSS)</b>			
<u>NINAU</u> . To BA362 at 2500 ft minimum, 7000 ft maximum. To BA384 at 2500 ft minimum, 4000 ft maximum. To BA502 at or above 2500 ft.	<u>NINAU</u> – BA362 [A2500+; A7000-] – BA384 [A2500+; A4000-] – BA502 [A2500+]	IF TF TF TF	Y - - -
<b>STAR PINPO 1P RNAV1 (GNSS)</b>			
<u>PINPO</u> at or above FL85. To BA365 at 2500 ft minimum, 4000 ft maximum, turn right. To BA503 at or above 2500 ft.	<u>PINPO</u> [F085+] – BA365 [A2500+; A4000-; R] – BA503 [A2500+]	IF TF TF	Y - -
<b>STAR PISPU 1P RNAV1 (GNSS)</b>			
<u>PISPU</u> at or above FL85. To BA365 at 2500 ft minimum, 4000 ft maximum, turn right. To BA503 at or above 2500 ft.	<u>PISPU</u> [F085+] – BA365 [A2500+; A4000-; R] – BA503 [A2500+]	IF TF TF	Y - -
<b>STAR POLMO 1P RNAV1 (GNSS)</b>			
<u>POLMO</u> at or above FL85. To BA382 at 2500 ft minimum, 4000 ft maximum, turn right. To BA503 at or above 2500 ft.	<u>POLMO</u> [F085+] – BA382 [A2500+; A4000-; R] – BA503 [A2500+]	IF TF TF	Y - -
<b>STAR RAMOL 1P RNAV1 (GNSS)</b>			
<u>RAMOL</u> at or above FL85. To BA382 at 2500 ft minimum, 4000 ft maximum, turn right. To BA503 at or above 2500 ft.	<u>RAMOL</u> [F085+] – BA382 [A2500+; A4000-] – BA503 [A2500+]	IF TF TF	Y - -
<b>STAR SISAU 1P RNAV1 (GNSS)</b>			
<u>SISAU</u> . To BA385 at 2500 ft minimum, 4000 ft maximum. To BA502 at or above 2500 ft.	<u>SISAU</u> – BA385 [A2500+; A4000-] – BA502 [A2500+]	IF TF TF	Y - -
<b>STAR SNT 1P RNAV1 (GNSS)</b>			
<u>SNT</u> . To BA501 at or above 2500 ft.	<u>SNT</u> – BA501 [A2500+]	IF TF	Y -



STANDARD INSTRUMENT  
RNAV(GNSS)  
ARRIVAL CHART  
(STAR)- ICAO

AD ELEV 91 FT

VAR 10° W  
TA 7000

APP	126.400
TWR	118.900

RABIL / Aristides Pereira Intl  
BOA VISTA  
RWY 21

TEXTUAL DESCRIPTION	ABBREVIATED DESCRIPTION	Expected Path Terminator Coding	Fly-Over Required
<p>NOTES APPLICABLE TO ALL SID:</p> <ul style="list-style-type: none"> <li>- RNAV 1 APPROVAL REQUIRED</li> <li>- REQUIRED GNSS</li> <li>- IAS MAX 250 kt BELOW FL100</li> </ul>			
<b>STAR NINAU 1Q RNAV1 (GNSS)</b>			
<u>NINAU</u> at 2500 ft minimum, 7000 ft maximum. To BA506 at or above 2500 ft.	<u>NINAU</u> [A2500+; A7000-] –BA506 [A2500+]	IF TF	Y -
<b>STAR PINPO 1Q RNAV1 (GNSS)</b>			
<u>PINPO</u> at or above FL85. To BA386. To BA504 at or above 2500 ft.	<u>PINPO</u> [F085+] – BA386 – BA504 [A2500+]	IF TF TF	Y - -
<b>STAR PISPU 1Q RNAV1 (GNSS)</b>			
<u>PISPU</u> at or above FL85. To BA386, turn right. To BA504 at or above 2500 ft.	<u>PISPU</u> [F085+] – BA386 – BA504 [A2500+]	IF TF TF	Y - -
<b>STAR POLMO 1Q RNAV1 (GNSS)</b>			
<u>POLMO</u> at or above FL85. To BA505 at or above 2500 ft.	<u>POLMO</u> [F085+] – BA505 [A2500+]	IF TF	Y -
<b>STAR RAMOL 1Q RNAV1 (GNSS)</b>			
<u>RAMOL</u> at or above FL85. To BA505 at or above 2500 ft.	<u>RAMOL</u> [F085+] - BA505 [A2500+]	IF TF	Y -
<b>STAR SISAU 1Q RNAV1 (GNSS)</b>			
<u>SISAU</u> . To BA362 at 2500 ft minimum, 7000 ft maximum. To BA506 at or above 2500 ft.	<u>SISAU</u> – BA362 [A2500+; A7000-] – BA506 [A2500+]	IF TF TF	Y - -
<b>STAR SNT 1Q RNAV1 (GNSS)</b>			
<u>SNT</u> . To BA369 at 2500 ft minimum, 7000 ft maximum, turn right. To BA372 at 2500 ft minimum, 4000 ft maximum, turn right. To BA506 at or above 2500 ft.	<u>SNT</u> – BA369 [A2500+; A7000-; R]– BA372 [A2500+; A4000-; R] - BA506 [A2500+]	IF TF TF TF	Y - - -

**STANDARD ARRIVAL  
CHART INSTRUMENT  
(STAR) - ICAO**

**AMILCAR CABRAL  
AIRPORT GVAC  
RWYs 01 & 19**

TA: 7000'  
VAR: 10W  
APP - 126.400  
TWR - 119.700

TA: 7000'  
VAR: 10W

**RABIL AIRPORT  
GVBA  
RWYs 03 & 21**

APP - 126.400  
TWR - 118.900

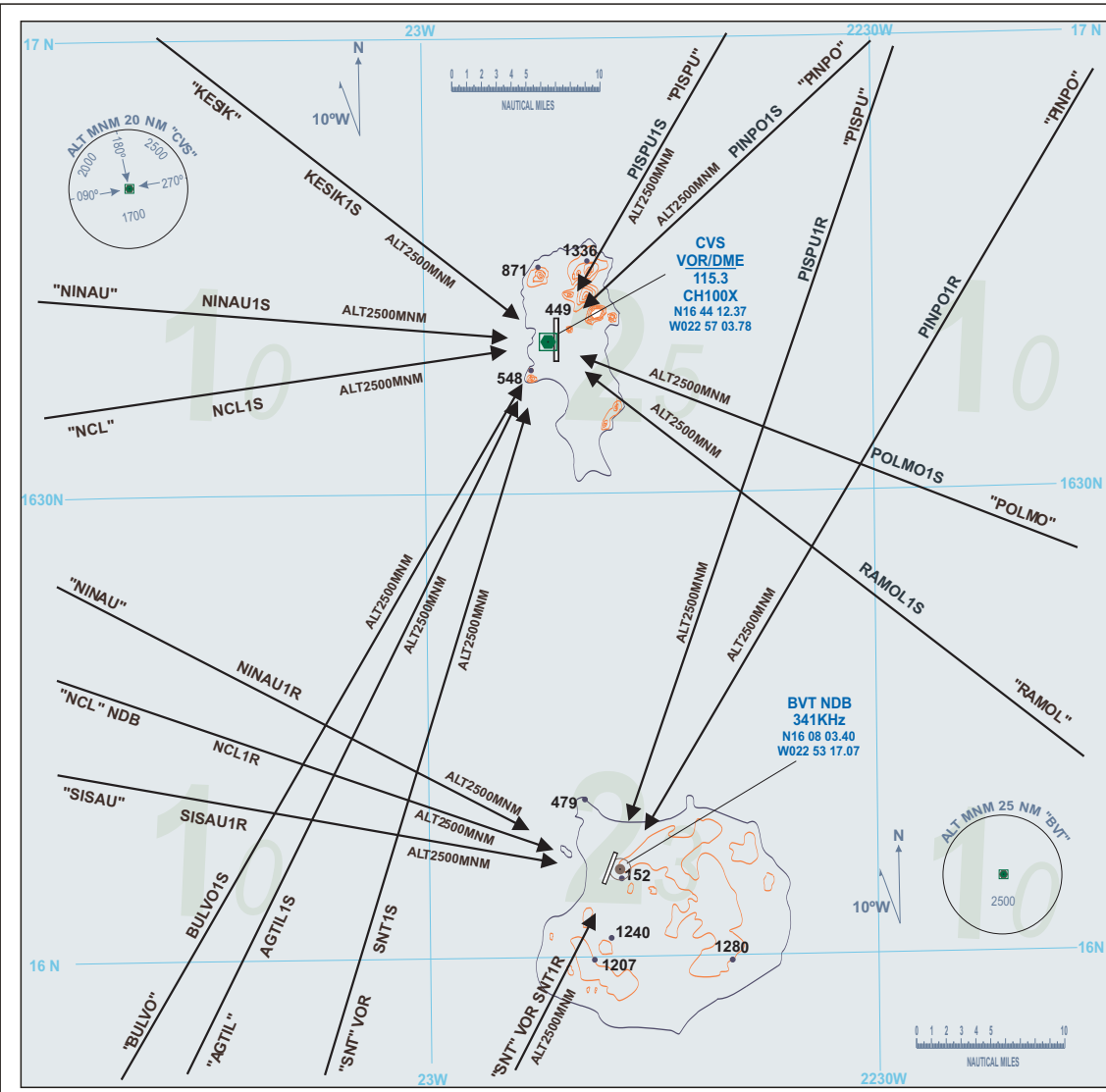

**Note:** Minimum safe altitudes (MSA) are indicated for each leg. Except in case of emergency or loss of communications altitudes to maintain are those assigned by ATC. These must respect the indicated MSAs.

**To GVAC:**

All arrivals proceed direct to CVS VOR MSA 2500ft for an ILS approach or request a visual approach.

**To GVBA:**

All arrivals proceed direct to BVT NDB MSA 2500ft for an ADF approach or request a visual approach.

INSTRUMENT  
APPROACH  
CHART - ICAO

AD ELEV 91 FT  
VAR 10°W

APP 126.400  
TWR 118.900

RABIL / Aristides Perelra Intl  
BOA VISTA  
RNAV (GNSS) RWY 03

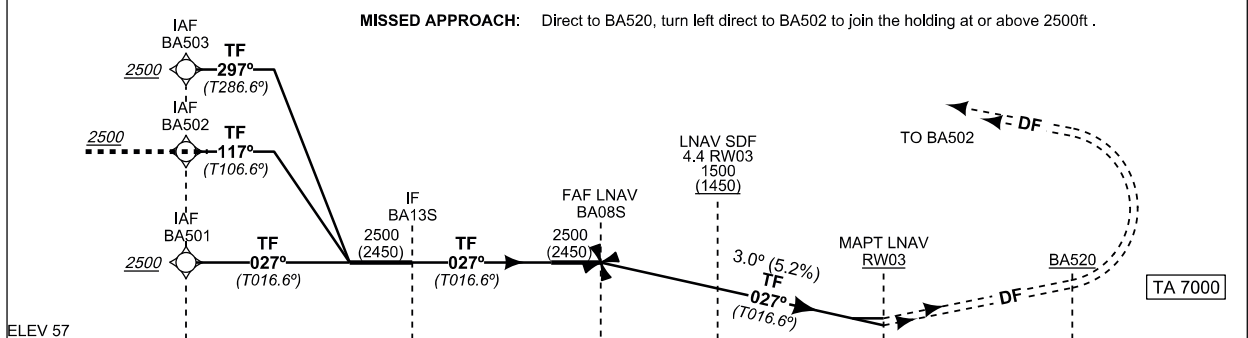
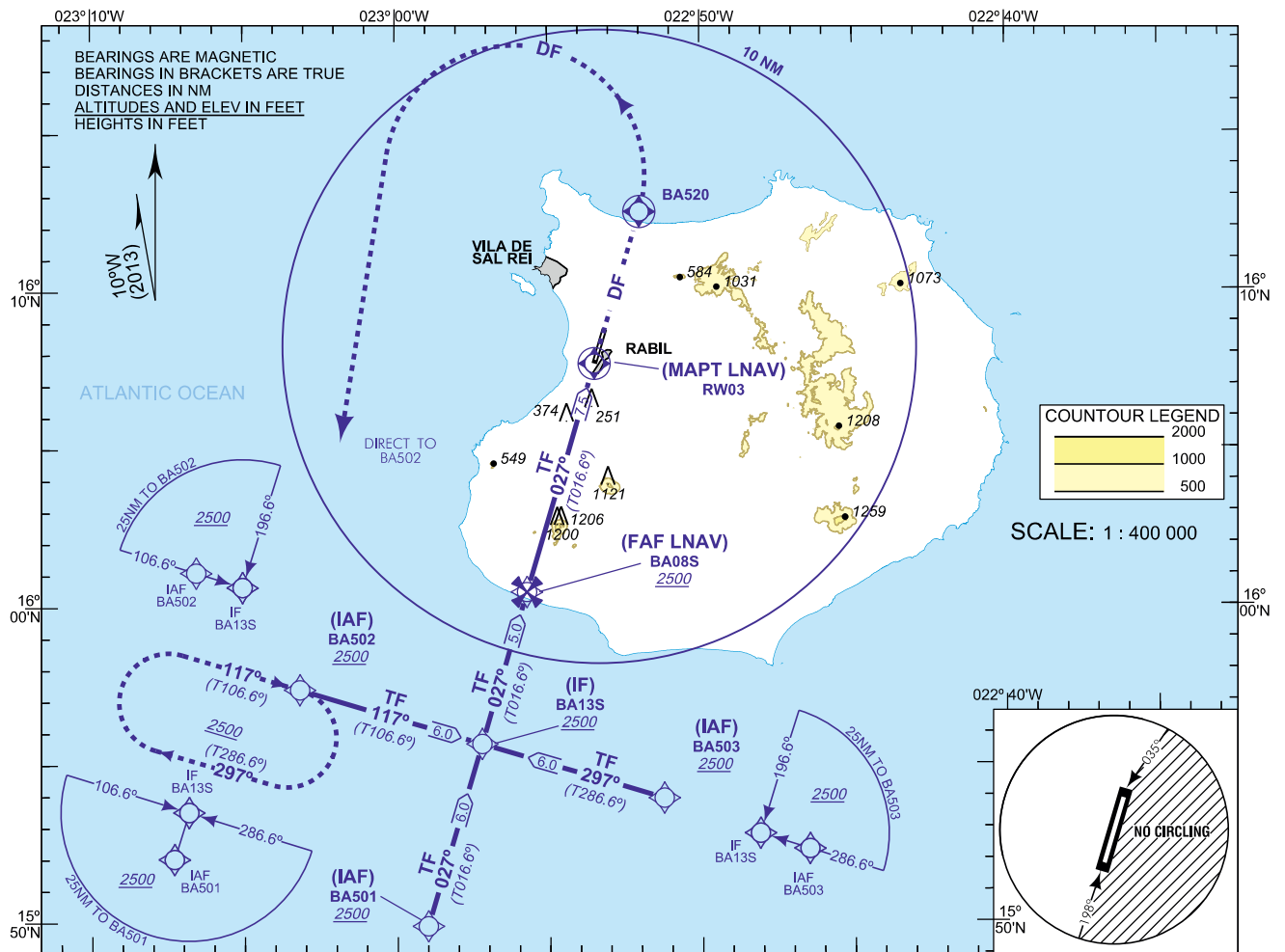

AIRCRAFT CATEGORY	A	B	C	D					
<b>OCA (OCH)</b>									
<b>680(630)</b>									
LNAV 2.5%									
LNAV/VNAV 2.5%	400(350)	410(360)	420(370)	430(380)					
CIRCLING	800(710)	800(710)	960(870)	1370(1280)					
RNP APCH REQUIRED.									
① TIMING IS NOT AUTHORIZED FOR DEFINING MAPT									
②									
③									
④									
LNAV/VNAV TEMPERATURE: MINIMUM 10°C MAXIMUM 45°C									
		RW 03	7	6	5	4	3	2	1
		ALT (HGT) FNA	2380 (2330)	2050 (2000)	1730 (1670)	1400 (1340)	1070 (1020)	750 (690)	430 (370)
		GS	kt	80	100	120	140	160	180
		FAF-MAPT:	min:s						
		ROD: 5.2 %	ft/min	425	531	637	743	849	955

## Instrument Approach Procedure RNAV (GNSS) RWY 03 coding table

PROCEDURE DESCRIPTION / APPROACH FROM BA501			
TEXTUAL DESCRIPTION	ABBREVIATED DESCRIPTION	EXPECTED PATH TERMINATOR CODING	FLY-OVER REQUIRED
BA501 at 2500 ft or above	BA501 [A2500+]	IF	-
to BA13S (IF) at 2500 ft or above	BA13S [A2500+]	TF	-
to BA08S (FAF) at 2500 ft or above	BA08S [A2500+]	TF	-
to <u>RW03</u> at 106 ft or above	<u>RW03</u> [A106+]	TF	Y
MISSED APPROACH			
Direct to <u>BA520</u> , turn left	<u>BA520</u> [L]	DF	Y
Direct to BA502 {HM; R, T106.6; 1min} at 2500 ft or above	BA502 [HM; R; T106.6; 1min; A2500+]	DF	-

PROCEDURE DESCRIPTION / APPROACH FROM BA502			
TEXTUAL DESCRIPTION	ABBREVIATED DESCRIPTION	EXPECTED PATH TERMINATOR CODING	FLY-OVER REQUIRED
BA502 at 2500 ft or above	<b>BA502</b> [A2500+]	IF	-
to BA13S (IF) at 2500 ft or above	BA13S [A2500+]	TF	-
to BA08S (FAF) at 2500 ft or above	BA08S [A2500+]	TF	-
to <u>RW03</u> at 106 ft or above	<u>RW03</u> [A106+]	TF	Y
MISSED APPROACH			
Direct to <u>BA520</u> , turn left	<u>BA520</u> [L]	DF	Y
Direct to BA502 {HM; R, T106.6; 1min} at 2500 ft or above	BA502 [HM; R; T106.6; 1min; A2500+]	DF	-

PROCEDURE DESCRIPTION / APPROACH FROM BA503			
TEXTUAL DESCRIPTION	ABBREVIATED DESCRIPTION	EXPECTED PATH TERMINATOR CODING	FLY-OVER REQUIRED
BA503 at 2500 ft or above	<b>BA503</b> [A2500+]	IF	-
to BA13S (IF) at 2500 ft or above	BA13S [A2500+]	TF	-
to BA08S (FAF) at 2500 ft or above	BA08S [A2500+]	TF	-
to <u>RW03</u> at 106 ft or above	<u>RW03</u> [A106+]	TF	Y
MISSED APPROACH			
Direct to <u>BA520</u> , turn left	<u>BA520</u> [L]	DF	Y
Direct to BA502 {HM; R, T106.6; 1min} at 2500 ft or above	BA502 [HM; R; T106.6; 1min; A2500+]	DF	-

CHANGE: Path Description

INSTRUMENT  
APPROACH  
CHART - ICAO

AD ELEV 91 FT  
VAR 10°W

APP 126.400  
TWR 118.900

RABIL / Aristides Pereira Intl  
BOA VISTA  
RNAV (GNSS) RWY 21

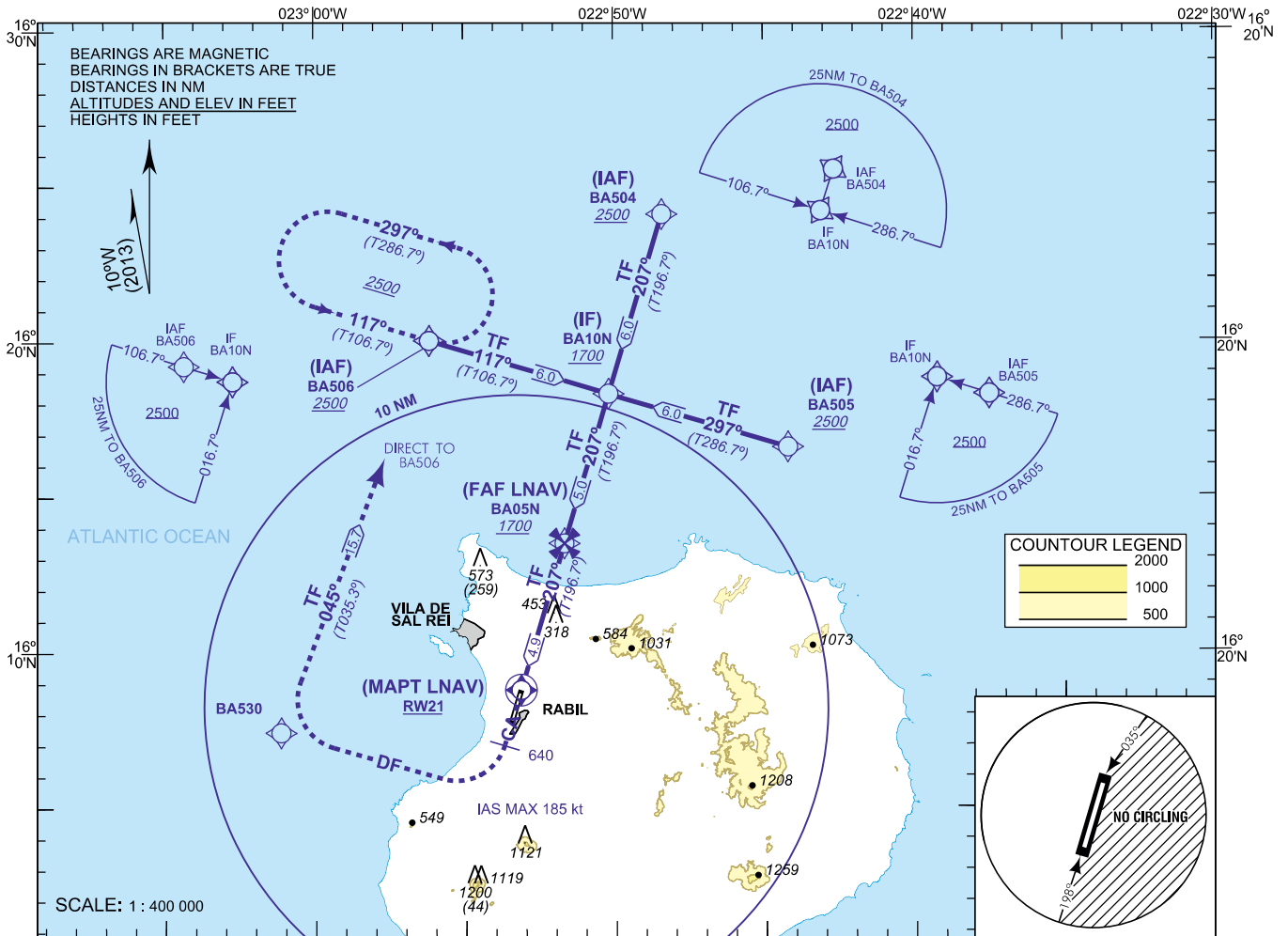

**MISSED APPROACH:** Climb on track 207°M, at or above 640ft turn right, maximum speed 185 Kt. Direct to BA530, turn right. Direct to BA506 to join the holding at or above 2500ft.

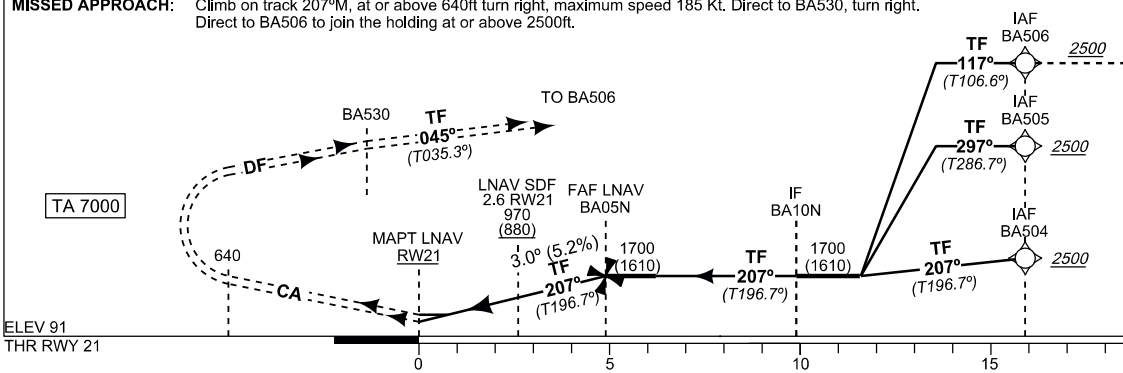

AIRCRAFT CATEGORY	A	B	C	D
	<b>OCA (OCH)</b>			
LNAV 2.5%	<b>620(530)</b>			
LNAV/VNAV 2.5%	<b>500(410)</b>	<b>520(430)</b>		<b>530(440)</b>
CIRCLING	<b>800(710)</b>	<b>800(710)</b>		<b>1370(1280)</b>
RNP APCH REQUIRED.				
① TIMING IS NOT AUTHORIZED FOR DEFINING MAPT				
②				
③				
④				
LNAV/VNAV TEMPERATURE: MINIMUM 10°C MAXIMUM 45°C				
	RW 21			
ALT (HGT) FNA			4 1430 (1340)	3 1100 (1010)
			2 780 (690)	
	GS	kt	80	100
	FAF-MAPT:	min:s	120	140
	ROD: 5.24 %	ft/min	425	531
			637	743
			849	955

## Instrument Approach Procedure RNAV (GNSS) RWY 21 coding table

PROCEDURE DESCRIPTION / APPROACH FROM BA504			
TEXTUAL DESCRIPTION	ABBREVIATED DESCRIPTION	EXPECTED PATH TERMINATOR CODING	FLY-OVER REQUIRED
BA504 at 2500 ft or above	BA504 [A2500+]	IF	-
to BA10N (IF) at 1700 ft or above	BA10N [A1700+]	TF	-
to BA05N (FAF) at 1700 ft or above	BA05N [A1700+]	TF	-
to <u>RW21</u> at 140 ft or above	<u>RW21</u> [A140+]	TF	Y
MISSED APPROACH			
From RW21 climb on track 207°M, at 640 ft turn right.	[M207; A640; R]	FA	-
Direct to BA530, turn right	BA530 [R]	DF	-
to BA506 {HM; L, T106.7; 1min} at 2500 ft or above	BA506 [HM; L; T106.7; 1min; A2500+]	TF	-

PROCEDURE DESCRIPTION / APPROACH FROM BA505			
TEXTUAL DESCRIPTION	ABBREVIATED DESCRIPTION	EXPECTED PATH TERMINATOR CODING	FLY-OVER REQUIRED
BA505 at 2500 ft or above	BA505 [A2500+]	IF	-
to BA10N (IF) at 1700 ft or above	BA10N [A1700+]	TF	-
to BA05N (FAF) at 1700 ft or above	BA05N [A1700+]	TF	-
to <u>RW21</u> at 140 ft or above	<u>RW21</u> [A140+]	TF	Y
MISSED APPROACH			
From RW21 climb on track 207°M, at 640 ft turn right.	[M207; A640; R]	FA	-
Direct to BA530, turn right	BA530 [R]	DF	-
to BA506 {HM; L, T106.7; 1min} at 2500 ft or above	BA506 [HM; L; T106.7; 1min; A2500+]	TF	-

PROCEDURE DESCRIPTION / APPROACH FROM BA506			
TEXTUAL DESCRIPTION	ABBREVIATED DESCRIPTION	EXPECTED PATH TERMINATOR CODING	FLY-OVER REQUIRED
BA506 at 2500 ft or above	<b>BA506</b> [A2500+]	IF	-
to BA10N (IF) at 1700 ft or above	BA10N [A1700+]	TF	-
to BA05N (FAF) at 1700 ft or above	BA05N [A1700+]	TF	-
to <u>RW21</u> at 140 ft or above	<u>RW21</u> [A140+]	TF	Y
MISSED APPROACH			
From RW21 climb on track 207°M, at 640 ft turn right.	[M207; A640; R]	FA	-
Direct to BA530, turn right	BA530 [R]	DF	-
to BA506 {HM; L, T106.7; 1min} at 2500 ft or above	BA506 [HM; L; T106.7; 1min; A2500+]	TF	-

CHANGE: Path Description



APPROACH INSTRUMENT  
CHART-ICAO

ELEV AD  
91

APP - 126.400  
TWR - 118.900

BOA VISTA  
ARISTIDES PEREIRA  
NDB RWY 21

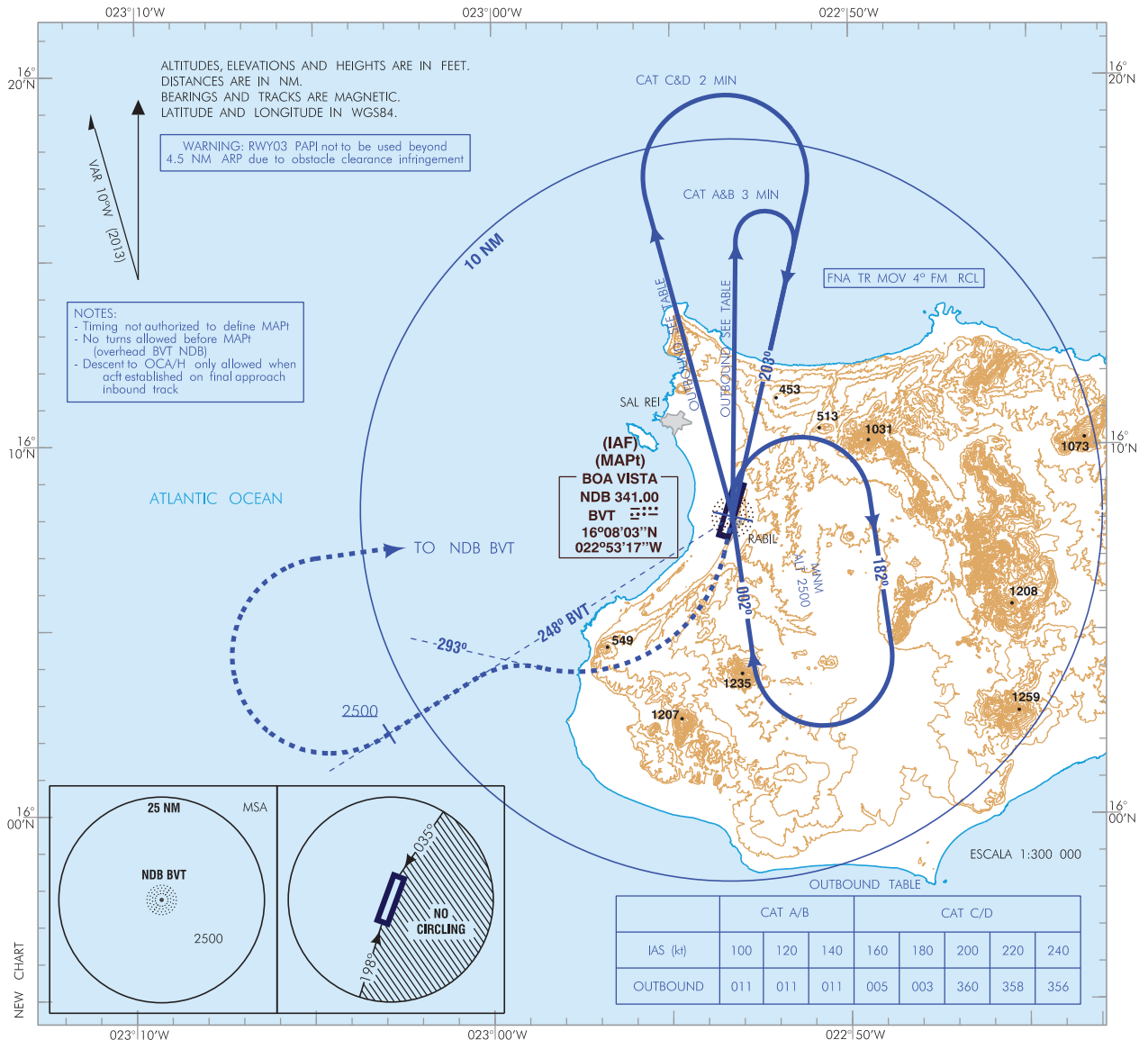

MISSED APCH: TURN RIGHT ON MAPt TO FOLLOW MAGNETIC TRACK 293°. TURN LEFT TO FOLLOW MAGNETIC TRACK 248°. CLIMB TO 2500 FT. TURN RIGHT DIRECT TO BVT NDB TO ENTER HOLD OR AS INSTRUCTED BY ATC.

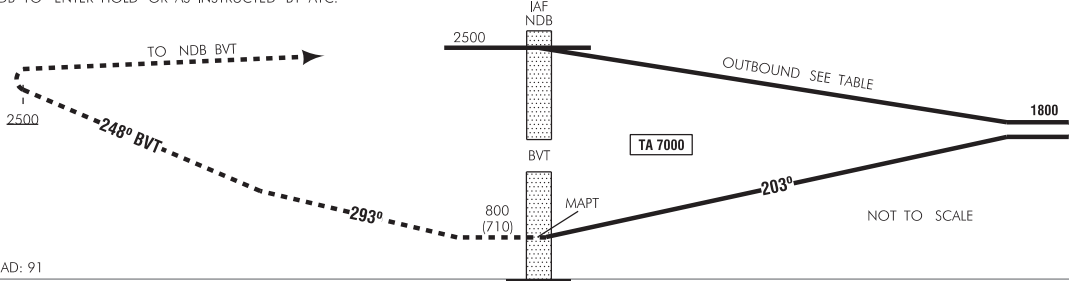

HGT REF ELEV AD

OCA/H	A	B	C	D
2.5%	800 (710)			
STA				
Circling (H) over 91	800 (710)	800 (710)	960 (870)	1370 (1280)

GS	kt	80	100	120	140	160	180					
FAF-THR:	min:s											
FAF-MAPT:	min:s											
ROD:	ft/min											
ALT/HGT DME FNA												
13 DME	12 DME	11 DME	10 DME	9 DME	8 DME	7 DME	6 DME	5 DME	4 DME	3 DME	2 DME	1 DME

VISUAL  
APPROACH  
CHART - ICAO

AERODROME ELEV - 91 ft  
16°08'14" N  
022°53'19" W

TWR 118.9  
APP 126.4

BOA VISTA/RABIL  
VISUAL ARR

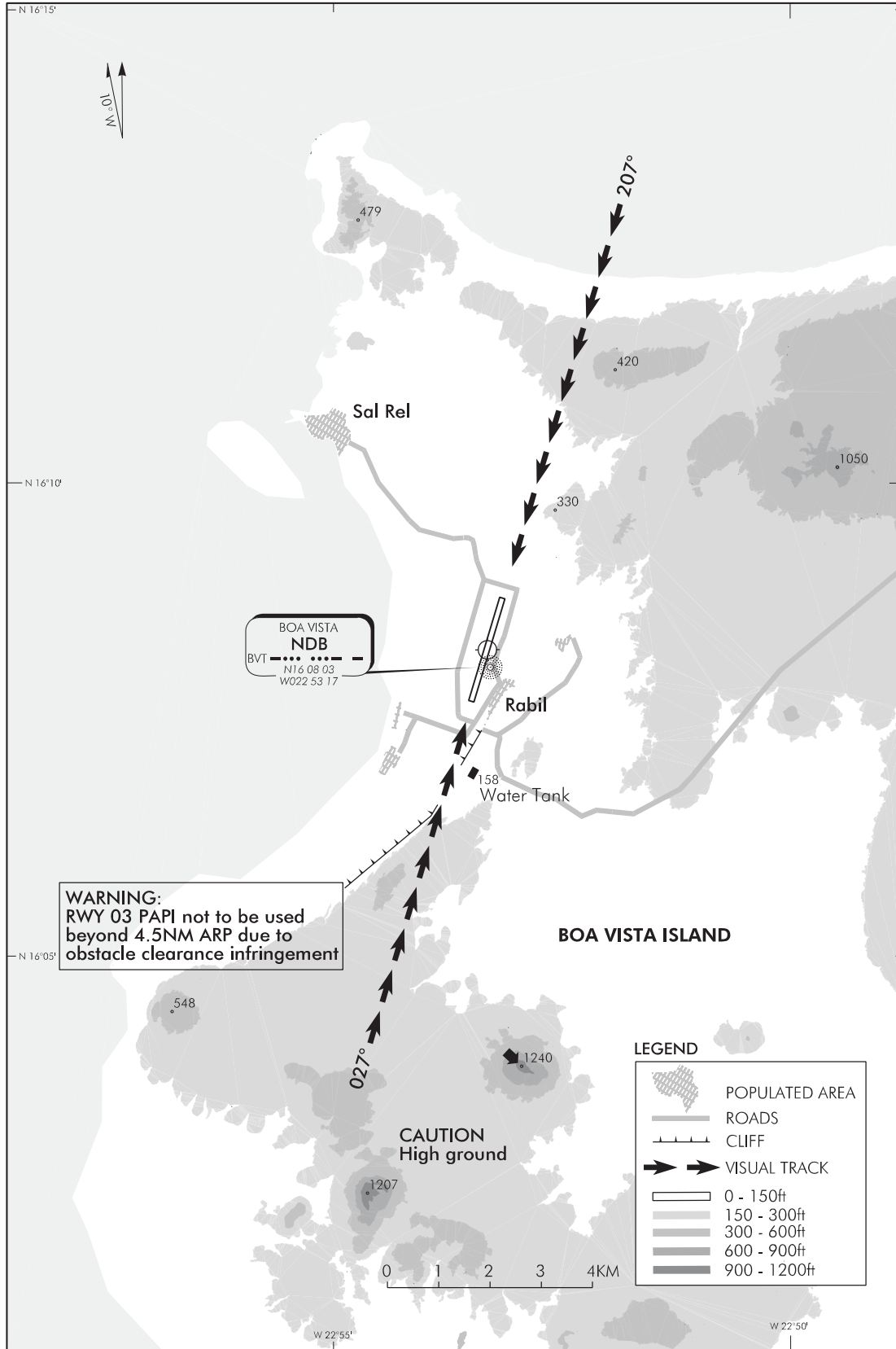

**WARNING:**  
RWY 03 PAPI not to be used  
beyond 4.5NM ARP due to  
obstacle clearance infringement

BOA VISTA/RABIL  
VISUAL ARR

**GVMA AD 2.1 AERODROME LOCATION INDICATOR AND NAME**

GVMA - MAIO ISLAND / MAIO

**GVMA AD 2.2 AERODROME GEOGRAPHICAL AND ADMINISTRATIVE DATA**

1	ARP coordinates and site at AD	150921N 0231249W Midpoint of RWY 01 / 19
2	Direction and distance from city	2 KM S of Barreiro
3	Elevation / Reference temperature / Mean low temperature	18 M (59 FT) / 30° C / NIL
4	Geoid Undulation at AD ELEV PSN	NIL
5	MAG VAR / Date of information / Annual change	9°W (2020) / 0.18° decreasing
6	AD operator, address, telephone, telefax, e-mail, AFS, website	ASA - Empresa Nacional de Aeroportos e Seguranca Aerea Aeroporto do Maio Porto Ingles Maio Island Republic of Cabo Verde TEL: +238 2551108 Telefax:+238 2551108 e-mail: NIL AFS: NIL Http: NIL
7	Types of traffic permitted (IFR/VFR)	VFR
8	Remarks	NIL

**GVMA AD 2.3 OPERATIONAL HOURS**

1	AD operator	HO
2	Customs and immigration	NIL
3	Health and sanitation	NIL
4	AIS Briefing office	NIL
5	ATS Reporting office (ARO)	NIL
6	MET Briefing office	NIL
7	ATS	NIL
8	Fuelling	NIL
9	Handling	HO
10	Security	HO
11	De-icing	NIL
12	Remarks	NIL

**GVMA AD 2.4 HANDLING SERVICES AND FACILITIES**

1	Cargo handling facilities	NIL
2	Fuel / oil types	NIL
3	Fuelling facilities / capacity	NIL
4	De-icing facilities	NIL
5	Hangar space for visiting aircraft	NIL

6	<i>Repair facilities for visiting aircraft</i>	NIL
7	<i>Remarks</i>	NIL

#### GVMA AD 2.5 PASSENGER FACILITIES

1	<i>Hotel(s)</i>	In town
2	<i>Restaurant(s)</i>	In town
3	<i>Transportation</i>	Bus
4	<i>Medical facilities</i>	In town
5	<i>Bank and Post office</i>	In town
6	<i>Tourist office</i>	NIL
7	<i>Remarks</i>	NIL

#### GVMA AD 2.6 RESCUE AND FIRE FIGHTING SERVICES

1	<i>AD category for fire fighting</i>	CAT 5
2	<i>Rescue equipment</i>	NIL
3	<i>Capability for removal of disabled aircraft</i>	NIL
4	<i>Remarks</i>	NIL

#### GVMA AD 2.7 SEASONAL AVAILABILITY - CLEARING

1	<i>Type(s) of clearing equipment</i>	NIL
2	<i>Clearance priorities</i>	NIL
3	<i>Remarks</i>	NIL

#### GVMA AD 2.8 APRONS, TAXIWAYS AND CHECK LOCATIONS / POSITIONS DATA

1	<i>Apron designation, surface and strength</i>	Designation: APRON Surface: Asphalt Strength: 20 TON SIWL
2	<i>Taxiway designation, width, surface and strength</i>	Designation: TWY Width: 15 M Surface: Asphalt Strength: 20 TON SIWL
3	<i>Altimeter checkpoint location and elevation</i>	NIL
4	<i>VOR checkpoints</i>	NIL
5	<i>INS checkpoints</i>	NIL
6	<i>Remarks</i>	NIL

#### GVMA AD 2.9 SURFACE MOVEMENT GUIDANCE AND CONTROL SYSTEM AND MARKINGS

1	<i>Use of aircraft stand ID signs, TWY guide lines and visual docking / parking guidance system at aircraft stands</i>	NIL
2	<i>RWY and TWY markings and lights</i>	RWY: Designation, THR, TDZ, CL, marked TWY: CL, holding positions, marked

3	Stop bars and RWY guard lights	NIL
4	Other RWY protection measures	NIL
5	Remarks	NIL

**GVMA AD 2.10 AERODROME OBSTACLES**

<i>In Area 2</i>					
<i>OBST ID / Designation</i>	<i>OBST type</i>	<i>OBST position</i>	<i>ELEV / HGT</i>	<i>Markings / Type / Colour of lighting</i>	<i>Remarks</i>
<i>a</i>	<i>b</i>	<i>c</i>	<i>d</i>	<i>e</i>	<i>f</i>
NIL	NIL	NIL	NIL	NIL	NIL

<i>In Area 3</i>					
<i>OBST ID / Designation</i>	<i>OBST type</i>	<i>OBST position</i>	<i>ELEV / HGT</i>	<i>Markings / Type / Colour of lighting</i>	<i>Remarks</i>
<i>a</i>	<i>b</i>	<i>c</i>	<i>d</i>	<i>e</i>	<i>f</i>
NIL	NIL	NIL	NIL	NIL	NIL

To be developed.

**GVMA AD 2.11 METEOROLOGICAL INFORMATION PROVIDED**

1	<i>Associated MET office</i>	Aeronautical Meteo Station
2	<i>Hours of service</i> <i>MET office outside hours</i>	HO NIL
3	<i>Office responsible for TAF preparation</i> <i>Periods of validity</i> <i>Interval of issuance</i>	Analysis and weather forecast centre GVACYMYX 24 HR NIL
4	<i>Availability of TREND forecast</i> <i>Interval of issuance</i>	NIL
5	<i>Briefing / Consultation provided</i>	NIL
6	<i>Flight documentation</i> <i>Language(s) used</i>	NIL
7	<i>Charts and other information displayed or available for briefing or consultation</i>	NIL
8	<i>Supplementary equipment available for providing information</i>	Automated Weather Observing System (AWOS), Meteorological parameters available: Surface wind for RWY 01, temperature, dew point, relative humidity and altimeter setting.
9	<i>ATS units provided with information</i>	SAL ACC, SAL APP (AFIS)
10	<i>Additional information (Limitation of service, etc.)</i>	MET Observer HOD as per ATS

**GVMA AD 2.12 RUNWAY PHYSICAL CHARACTERISTICS**

<i>Designations RWY NR</i>	<i>True BRG</i>	<i>Dimensions of RWY(M)</i>	<i>Strength (PCN) &amp; surface of RWY and SWY</i>	<i>THR coordinates RWY end coordinates THR geoid undulation</i>	<i>THR elevation and highest elevation of TDZ of precision APP RWY</i>
<i>1</i>	<i>2</i>	<i>3</i>	<i>4</i>	<i>5</i>	<i>6</i>
01	002°	1200 X 30	20 TON SIWL NIL	150902.12N 0231249.98W 150941.15N 0231248.68W 29 M / 95 FT	7 M / 23 FT NIL

Designations RWY NR	True BRG	Dimensions of RWY(M)	Strength (PCN) & surface of RWY and SWY	THR coordinates RWY end coordinates THR geoid undulation	THR elevation and highest elevation of TDZ of precision APP RWY
1	2	3	4	5	6
19	182°	1200 X 30	20 TON SIWL NIL	150941.15N 0231248.68W 150902.12N 0231248.68W 29 M / 95 FT	18 M / 59 FT NIL

Slope of RWY-SWY	SWY dimensions (M)	CWY dimensions (M)	Strip dimensions (M)	RWY end safety area (M)	Location / description of arresting system	OFZ	Remarks
7	8	9	10	11	12	13	14
NIL	NIL	NIL	NIL	NIL	NIL	NIL	NIL
NIL	NIL	NIL	NIL	NIL	NIL	NIL	NIL

#### GVMA AD 2.13 DECLARED DISTANCES

RWY Designator	TORA (M)	TODA (M)	ASDA (M)	LDA (M)	Remarks
1	2	3	4	5	6
01	1200	1200	1200	1200	NIL
19	1200	1200	1200	1200	NIL

#### GVMA AD 2.14 APPROACH AND RUNWAY LIGHTING

RWY Designator	APCH LGT type LEN INTST	THR LGT colour WBAR	VASIS (MEHT) PAPI	TDZ LGT LEN	RWY CL LGT LEN, spacing, colour, INTST	RWY edge LGT LEN, spacing, colour INTST	RWY end LGT colour WBAR	SWY LGT LEN colour	Remarks
1	2	3	4	5	6	7	8	9	10
01	NIL	NIL	NIL	NIL	NIL	NIL	NIL	NIL	NIL
19	NIL	NIL	NIL	NIL	NIL	NIL	NIL	NIL	NIL

#### GVMA AD 2.15 OTHER LIGHTING SECONDARY POWER SUPPLY

1	ABN / IBN location, characteristics and hours of operation	NIL
2	LDI / Anemometer location and LGT	NIL
3	TWY ledge and CL lighting	NIL
4	Secondary power supply / switch - over time	NIL
5	Remarks	NIL

#### GVMA AD 2.16 HELICOPTER LANDING AREA

1	Coordinates TLOF or THR of FATO Geoid undulation	NIL
2	TLOF and / or FATO elevation M / FT	NIL
3	TLOF and FATO area dimensions, surface, strength, marking	NIL

4	True BRG of FATO	NIL
5	Declared distance available	NIL
6	APP and FATO lighting	NIL
7	Remarks	NIL

**GVMA AD 2.17 ATS AIRSPACE**

1	Designation and lateral limits	MAIO ATZ Circle of 5 NM centred on 150921N 0231249W (Maio Island / Maio ARP)
2	Vertical limits	GND / MSL - 2000 FT
3	Airspace classification	Class G
4	ATS unit call sign Language(s)	MAIO INFORMATION (AFIS) English, Portuguese
5	Transition altitude	NIL
6	Hours of applicability	HO
7	Remarks	NIL

**GVMA AD 2.18 ATS COMMUNICATION FACILITIES**

Service designation	Call sign	Channel(s)	SATVOICE number(s)	Logon address	Hours of operation	Remarks
1	2	3	4	5	6	7
AFIS	MAIO INFORMATION	118.500 MHZ	NIL	NIL	HJ	NIL

**GVMA AD 2.19 RADIO NAVIGATION AND LANDING AIDS**

Type of aid, MAG VAR Type of supported OPS (For VOR / ILS give declination)	ID	Frequency(ies) Channel number(s) service provider RPI	Hours of operation	Position of transmitting antenna coordinates	Elevation of the transmitting antenna of DME, GBAS reference point	Service volume radius from GBAS reference point	Remarks
1	2	3	4	5	6	7	8
NIL	NIL	NIL	NIL	NIL	NIL	NIL	NIL

**GVMA AD 2.20 LOCAL TRAFFIC REGULATIONS**

**1. Aerodrome regulations**

NIL

**6. Taxiing - Limitations**

NIL

**2. Taxiing to and from stands**

Arriving aircraft will be allocated a parking position by the marshaller and will always be guided by his assistance.

**7. School and training flights - Technical test flights - Use of runways**

NIL

**3. Parking area for small aircraft (general aviation)**

NIL

**8. Helicopter traffic - Limitations**

NIL

**4. Parking area for helicopters**

NIL

**9. Removal of disabled aircraft from runways**

NIL

**5. Apron - Taxiing during winter conditions**

NIL

**GVMA AD 2.21 NOISE ABATEMENT PROCEDURES**

NIL

**GVMA AD 2.22 FLIGHT PROCEDURES**

NIL

**GVMA AD 2.23 ADDITIONAL INFORMATION**

NIL

**GVMA AD 2.24 CHARTS RELATED TO AN AERODROME**

*Chart name*

*Page*

---

AERODROME CHART - ICAO

GVMA AD 2-7

VISUAL APPROACH CHART - ICAO

GVMA AD 2-8



**AERODROME CHART**      15°09'21"N      023°12'49"W      AD Elev.18m/59ft      **AFIS 118.5**      **MAIO**  
**AEROPORTO DO MAIO**

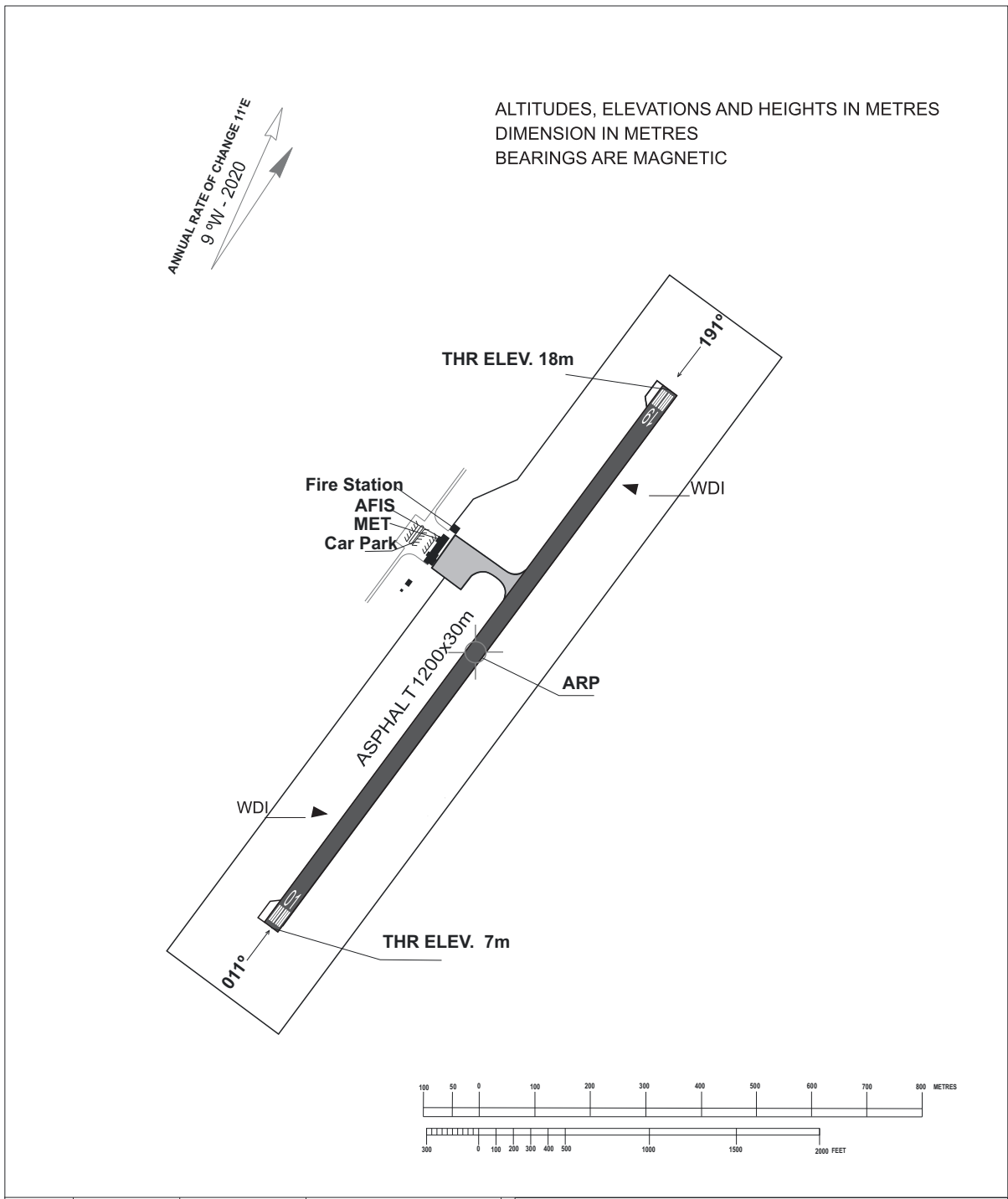

CHANGED: AFIS FREQUENCY

RWY	DIRECTION	THR	BEARING STRENGTH	DECLARED DISTANCES				
				RWY	TORA	TODA	ASDA	LDA
01	011°	15°09'02.12"N 023°12'49.98"W	20 TON SIWL					
19	191°	15°09'41.15"N 023°12'48.68"W	20 TON SIWL	01	1200	1200	1200	1200
				19	1200	1200	1200	1200
HELIPORT				OTHERS:				

**VISUAL APPROACH CHART**

15°09'21"N  
023°12'49"W AD Elev.18m/59ft

AFIS 118.5

**MAIO  
AEROPORTO DO MAIO**

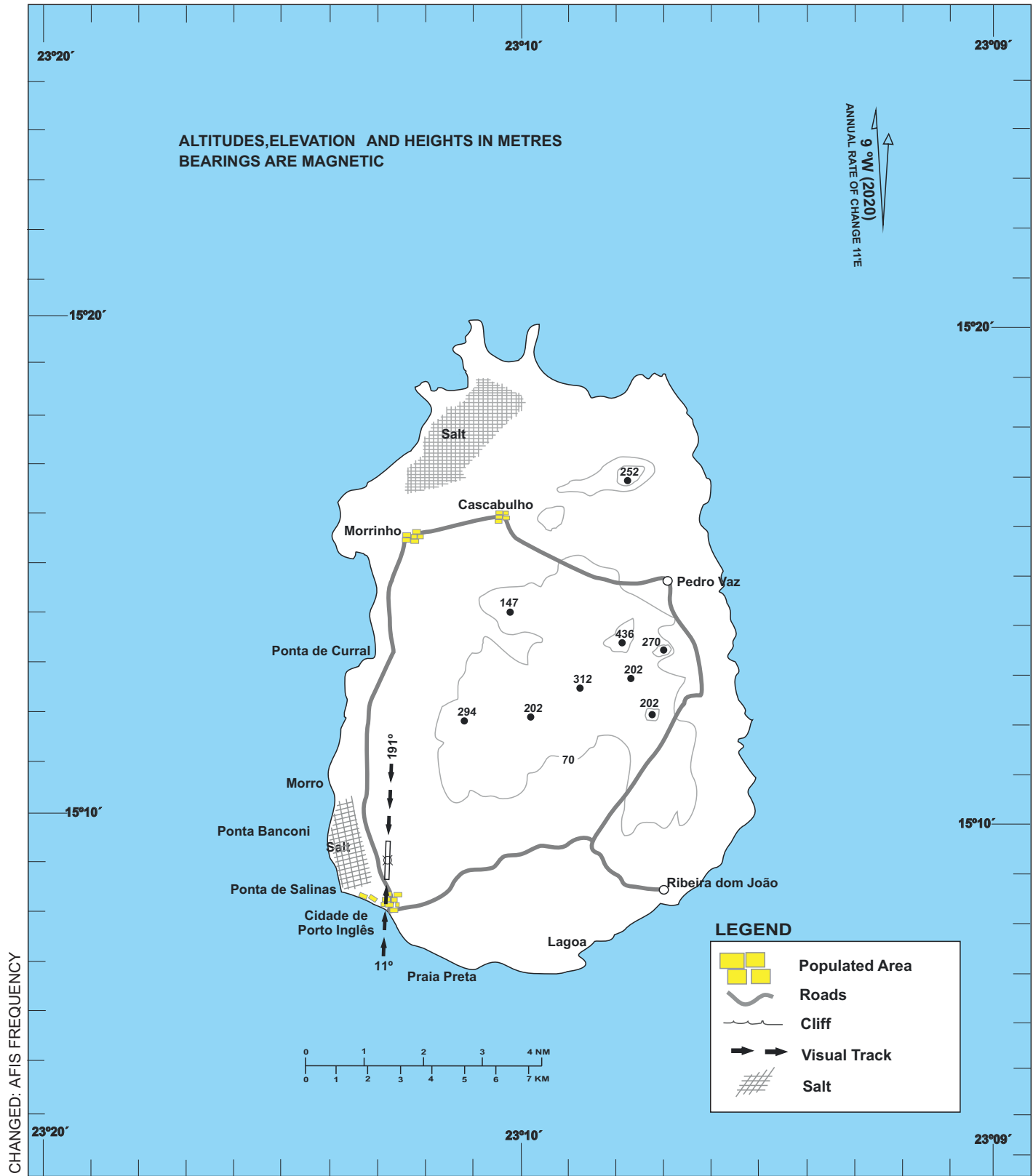

**GVNP AD 2.1 AERODROME LOCATION INDICATOR AND NAME**

GVNP - PRAIA / NELSON MANDELA

**GVNP AD 2.2 AERODROME GEOGRAPHICAL AND ADMINISTRATIVE DATA**

1	ARP coordinates and site at AD	145628N 0232905W Midpoint of RWY 03 / 21
2	Direction and distance from city	5 KM E of Praia
3	Elevation / Reference temperature / Mean low temperature	95 M (324 FT) / 30° C / NIL
4	Geoid Undulation at AD ELEV PSN	26.29 M (86.25 FT)
5	MAG VAR / Date of information / Annual change	11°W (2013) / 0.12° decreasing
6	AD operator, address, telephone, telefax, e-mail, AFS, website	ASA - Empresa Nacional de Aeroportos e Seguranca Aerea - S.A. Aeroporto Nelson Mandela Praia Santiago Island Republic of Cabo Verde TEL: +238 2608700 +238 2608715 Telefax:+238 2633876 e-mail: NIL AFS: GVNPYDYX Http: NIL
7	Types of traffic permitted (IFR/VFR)	IFR / VFR
8	Remarks	NIL

**GVNP AD 2.3 OPERATIONAL HOURS**

1	AD operator	H 24
2	Customs and immigration	H 24
3	Health and sanitation	H 24
4	AIS Briefing office	H 24
5	ATS Reporting office (ARO)	H 24
6	MET Briefing office	H 24
7	ATS	H 24
8	Fuelling	H 24
9	Handling	H 24
10	Security	H 24
11	De-icing	NIL
12	Remarks	NIL

**GVNP AD 2.4 HANDLING SERVICES AND FACILITIES**

1	Cargo handling facilities	Fork lift, high lift loader, vehicles and equipment air starter 40 PSI 250 PIM, pushback (160 TON)
2	Fuel / oil types	Jet A1 / NIL
3	Fuelling facilities / capacity	For Jet A1 max delivery rate: 1200 USG per MIN Fixed hydrant system
4	De-icing facilities	NIL

5	Hangar space for visiting aircraft	NIL
6	Repair facilities for visiting aircraft	Minor repairs
7	Remarks	NIL

#### GVNP AD 2.5 PASSENGER FACILITIES

1	Hotel(s)	In the city
2	Restaurant(s)	At AD and in the city
3	Transportation	Taxis, buses and rental cars
4	Medical facilities	First aid, ambulance at AD and hospital in the city
5	Bank and Post office	At AD and in the city
6	Tourist office	At AD and in the city
7	Remarks	NIL

#### GVNP AD 2.6 RESCUE AND FIRE FIGHTING SERVICES

1	AD category for fire fighting	CAT 7
2	Rescue equipment	NIL
3	Capability for removal of disabled aircraft	NIL
4	Remarks	All operators are required to put in place appropriate agreements for the supply of equipment for the removal of disabled aircraft at the airport movement area or at its proximity and to ensure its use when required. Operators are also required to submit such agreements for airport administration appraisal and recording.

#### GVNP AD 2.7 SEASONAL AVAILABILITY - CLEARING

1	Type(s) of clearing equipment	NIL
2	Clearance priorities	NIL
3	Remarks	NIL

#### GVNP AD 2.8 APRONS, TAXIWAYS AND CHECK LOCATIONS / POSITIONS DATA

1	Apron designation, surface and strength	Designation: APRON Surface: Concrete Strength: PCN 52 R / C / X / U
2	Taxiway designation, width, surface and strength	Designation: TWY A / TWY B / TWY C Width: 30 M Surface: Asphalt Strength: PCN 49 F / B / X / U
3	Altimeter checkpoint location and elevation	TWY South 94.03 M (309.7 FT)
4	VOR checkpoints	TWY South 94.03 M (309.7 FT)
5	INS checkpoints	TWY South 94.03 M (309.7 FT)
6	Remarks	NIL

**GVNP AD 2.9 SURFACE MOVEMENT GUIDANCE AND CONTROL SYSTEM AND MARKINGS**

1	Use of aircraft stand ID signs, TWY guide lines and visual docking / parking guidance system at aircraft stands	Taxiing guidance signs at all intersections with TWY and RWY at all holding positions. Guidelines on APRON. Nose - in guidance at aircraft stands.
2	<i>RWY and TWY markings and lights</i>	RWY: Designation, THR, TDZ, CL, RWY end TWY: CL
3	Stop bars and RWY guard lights	NIL
4	<i>Other RWY protection measures</i>	NIL
5	<i>Remarks</i>	NIL

**GVNP AD 2.10 AERODROME OBSTACLES**

<i>In Area 2</i>						
<i>OBST ID / Designation</i>	<i>OBST type</i>	<i>OBST position</i>	<i>ELEV / HGT</i>	<i>Markings / Type / Colour of lighting</i>	<i>Remarks</i>	
<i>a</i>	<i>b</i>	<i>c</i>	<i>d</i>	<i>e</i>	<i>f</i>	
NIL	NIL	NIL	NIL	NIL	NIL	

<i>In Area 3</i>						
<i>OBST ID / Designation</i>	<i>OBST type</i>	<i>OBST position</i>	<i>ELEV / HGT</i>	<i>Markings / Type / Colour of lighting</i>	<i>Remarks</i>	
<i>a</i>	<i>b</i>	<i>c</i>	<i>d</i>	<i>e</i>	<i>f</i>	
NIL	NIL	NIL	NIL	NIL	NIL	

To be developed.

**GVNP AD 2.11 METEOROLOGICAL INFORMATION PROVIDED**

1	<i>Associated MET office</i>	Aeronautical MET Station
2	<i>Hours of service MET office outside hours</i>	H 24 NIL
3	<i>Office responsible for TAF preparation Periods of validity Interval of issuance</i>	Analysis and weather forecast centre GVACYMYX 24 HR NIL
4	<i>Availability of TREND forecast Interval of issuance</i>	NIL
5	<i>Briefing / Consultation provided</i>	NIL
6	<i>Flight documentation Language(s) used</i>	NIL
7	Charts and other information displayed or available for briefing or consultation	NIL
8	Supplementary equipment available for providing information	Automated Weather Observing System (AWOS); Meteorological parameters available: Surface wind for both RWYs, visibility, temperature, dew point, relative humidity, sky conditions, cloud height and amount, altimeter setting and rainfall.
9	<i>ATS units provided with information</i>	NELSON MANDELA TWR, SAL APP, SAL ACC
10	<i>Additional information (Limitation of service, etc.)</i>	Aviation meteorological parameters permanently broadcast on 127.700 MHZ.

**GVNP AD 2.12 RUNWAY PHYSICAL CHARACTERISTICS**

Designations RWY NR	True BRG	Dimensions of RWY(M)	Strength (PCN) and surface of RWY and SWY	THR coordinates RWY end coordinates THR geoid undulation	THR elevation and highest elevation of TDZ of precision APP RWY
1	2	3	4	5	6
03	021.96°	2100 X 45	PCN 49 F / B / X / U NIL	145602.61N 0232915.49W 145556.31N 0232918.10W 86.25 FT	310.2 FT 314.6 FT
21	201.96°	2100 X 45	PCN 49 F / B / X / U NIL	145659.57N 0232851.84W 145659.75N 0232851.77W 86.25 FT	324.9 FT 316.8 FT

Slope of RWY-SWY	SWY dimensions (M)	CWY dimensions (M)	Strip dimensions (M)	RWY end safety area (M)	Location / description of arresting system	OFZ	Remarks
7	8	9	10	11	12	13	14
0.32 %	NIL	NIL	2220 X 150	NIL	NIL	NIL	NIL
0.32 %	NIL	NIL	2220 X 150	200 X 90	NIL	NIL	NIL

**GVNP AD 2.13 DECLARED DISTANCES**

RWY Designator	TORA (M)	TODA (M)	ASDA (M)	LDA (M)	Remarks
1	2	3	4	5	6
03	2100	2100	2100	1900	DTHR 200 M
21	2005	2005	2005	2005	NIL

**GVNP AD 2.14 APPROACH AND RUNWAY LIGHTING**

RWY Designator	APCH LGT type LEN INTST	THR LGT colour WBAR	VASIS (MEHT) PAPI	TDZ LGT LEN	RWY CL LGT LEN, spacing, colour, INTST	RWY edge LGT LEN, spacing, colour INTST	RWY end LGT colour WBAR	SWY LGT LEN colour	Remarks
1	2	3	4	5	6	7	8	9	10
03	Simple	green	PAPI 3° (55 FT)	NIL	NIL	white	red	NIL	NIL
21	Simple	green	PAPI 3° (48 FT)	NIL	NIL	white	red	NIL	NIL

**GVNP AD 2.15 OTHER LIGHTING SECONDARY POWER SUPPLY**

1	ABN / IBN location, characteristics and hours of operation	ABN: Tower building, FLG G / W every 5 SEC, HO / IMC W 160.000 CD G 20.000 CD
2	LDI / Anemometer location and LGT	NIL / Anemometer cup RWY 03 LGTD
3	TWY ledge and CL lighting	Edge: All TWYs CL: NIL
4	Secondary power supply / switch - over time	15 SEC
5	Remarks	WDI: Left hand side of each RWY ABM TDZ areas

**GVNP AD 2.16 HELICOPTER LANDING AREA**

1	Coordinates TLOF or THR of FATO Geoid undulation	NIL
---	---	-----

2	TLOF and / or FATO elevation M / FT	NIL
3	TLOF and FATO area dimensions, surface, strength, marking	NIL
4	True BRG of FATO	NIL
5	Declared distance available	NIL
6	APP and FATO lighting	NIL
7	Remarks	NIL

**GVNP AD 2.17 ATS AIRSPACE**

1	Designation and lateral limits	PRAIA CTR Area delimited by two arcs of 15 NM radius centred respectively on 145628N 0232905W (Praia / Nelson Mandela) and 151000N 0234000W and the tangents joining these arcs.
2	Vertical limits	GND / MSL - FL 85
3	Airspace classification	Class C
4	ATS unit call sign Language(s)	PRAIA TOWER English, Portuguese
5	Transition altitude	7000 FT
6	Hours of applicability	H 24
7	Remarks	NIL

**GVNP AD 2.18 ATS COMMUNICATION FACILITIES**

Service designation	Call sign	Channel(s)	SATVOICE number(s)	Logon address	Hours of operation	Remarks
1	2	3	4	5	6	7
APP / TWR	PRAIA TOWER	118.200 MHZ 121.500 MHZ	NIL	NIL	H 24	NIL Emergency

**GVNP AD 2.19 RADIO NAVIGATION AND LANDING AIDS**

Type of aid, MAG VAR Type of supported OPS (For VOR / ILS give declination)	ID	Frequency(ies) Channel number(s) service provider RPI	Hours of operation	Position of transmitting antenna coordinates	Elevation of the transmitting antenna of DME, GBAS reference point	Service volume radius from GBAS reference point	Remarks
1	2	3	4	5	6	7	8
VOR/DME (11°W)	SNT	116.600 MHZ (113X)	H 24	145620.74N 0232855.64W	101 M (340.3 FT)	NIL	Coverage: 200 NM / FL 500
NDB (12°W)	PRA	349 KHZ	H 24	145532.22N 0232928.14W	NIL	NIL	NIL

### GVNP AD 2.20 LOCAL TRAFFIC REGULATIONS

**1. Aerodrome regulations**

Two way communications.

overnight aircraft shall refuel prior to be removed to a remote position for overnight.

**2. Taxiing to and from stands**

Arriving aircraft will be allocated a stand number by the SMC and will be guided by the marshaller assistance.

**3. Parking area for small aircraft (general aviation)**

NIL

**4. Parking area for helicopters**

NIL

**5. Apron - taxiing during winter conditions**

NIL

**6. Taxiing - limitations**

NIL

**7. School and training flights - Technical test flights - Use of runways**

NIL

**8. Helicopter traffic - limitations**

NIL

**9. Removal of disabled aircraft from runways**

When an aircraft is wrecked on the runway, it is the duty of the owner or user of such aircraft to have it removed as soon as possible. If a wrecked aircraft is not removed from the runway as quickly as possible by the owner or user, the aircraft will be removed by the aerodrome authority at the owner's expenses.

### GVNP AD 2.21 NOISE ABATEMENT PROCEDURES

Not applicable

### GVNP AD 2.22 FLIGHT PROCEDURES

**1. General**

**1.1 Minimum Sector Altitude**

Four sectors within a circle of 25 NM centred at SNT VOR:

SW sector R226 - R280 - 3900 FT

NW sector R281 - R020 - 6600 FT

NE sector R021 - R080 - 3400 FT

SE sector R081 - R225 - 2500 FT

**1.2 Restrictions**

Due presence of permanent obstacles in a circular area of 1 NM radius centred at 145826.21N 0233056.16W, it is strictly prohibited:

1.2.1 *Left hand traffic circuit RWY 03*

1.2.2 *Right hand traffic circuit RWY 21*

**Note:** *The entrance to the holding procedure must be performed at an altitude of 2100 FT or above.*

**2. Procedures for IFR flights within the aerodrome CTR**

NIL

**3. Radar procedures within aerodrome CTR**

**3.1 Radar vectoring and sequencing**

NIL

**3.2 Surveillance radar approaches**

NIL

**3.3 Precision radar approaches**

NIL

**4. Communication failure**

In the event of communication failure the pilot shall act in accordance with communication failure procedures in ICAO Annex 2. For PRAIA CTR information concerning the associated navigation aids and the routing is given in **ENR 4.1.1**.

**5. Procedures for VFR flights within aerodrome CTR**

Flight plan shall be filed for the flight concerned.

ATC clearance shall be obtained from the control tower.

A revised ATC clearance must be obtained before any deviation from the clearance in force.

Two - way radio communication shall be established on the prescribed frequency before flights take place in the CTR.

### GVNP AD 2.23 ADDITIONAL INFORMATION

NIL



**GVNP AD 2.24 CHARTS RELATED TO AN AERODROME**

<i>Chart name</i>	<i>Page</i>
AERODROME CHART - ICAO	GVNP AD 2-8
AIRCRAFT PARKING / DOCKING CHART - ICAO	GVNP AD 2-9
AERODROME OBSTACLE CHART RWY 03 / 21 - ICAO TYPE A	GVNP AD 2-10
STANDARD DEPARTURE CHART - INSTRUMENT (SID) RNAV RWY 03 - ICAO	GVNP AD 2-11
STANDARD DEPARTURE CHART - INSTRUMENT (SID) RNAV RWY 21 - ICAO	GVNP AD 2-12
STANDARD ARRIVAL CHART - INSTRUMENT (STAR) RNAV RWY 03 / 21 - ICAO	GVNP AD 2-13
STANDARD ARRIVAL CHART - INSTRUMENT (STAR) RNAV RWY 03 / 21 (VERSO) - ICAO	GVNP AD 2-14
INSTRUMENT APPROACH CHART VOR / DME RWY 03 CAT A - D - ICAO	GVNP AD 2-15
INSTRUMENT APPROACH CHART NDB RWY 03 CAT A - B - ICAO	GVNP AD 2-16
INSTRUMENT APPROACH CHART NDB RWY 03 CAT C - D - ICAO	GVNP AD 2-17
INSTRUMENT APPROACH CHART VOR / DME RWY 21 CAT A - D - ICAO	GVNP AD 2-18
INSTRUMENT APPROACH CHART NDB RWY 21 CAT A - B - ICAO	GVNP AD 2-19
INSTRUMENT APPROACH CHART NDB RWY 21 CAT C - D - ICAO	GVNP AD 2-20
VISUAL APPROACH CHART - ICAO	GVNP AD 2-21

**AERODROME  
CHART - ICAO**

14°56'28"N  
023°29'05"W

ELEV-324 FT

TWR - 118.2

**AEROPORTO INTL DA  
PRAIA/NELSON MANDELA**

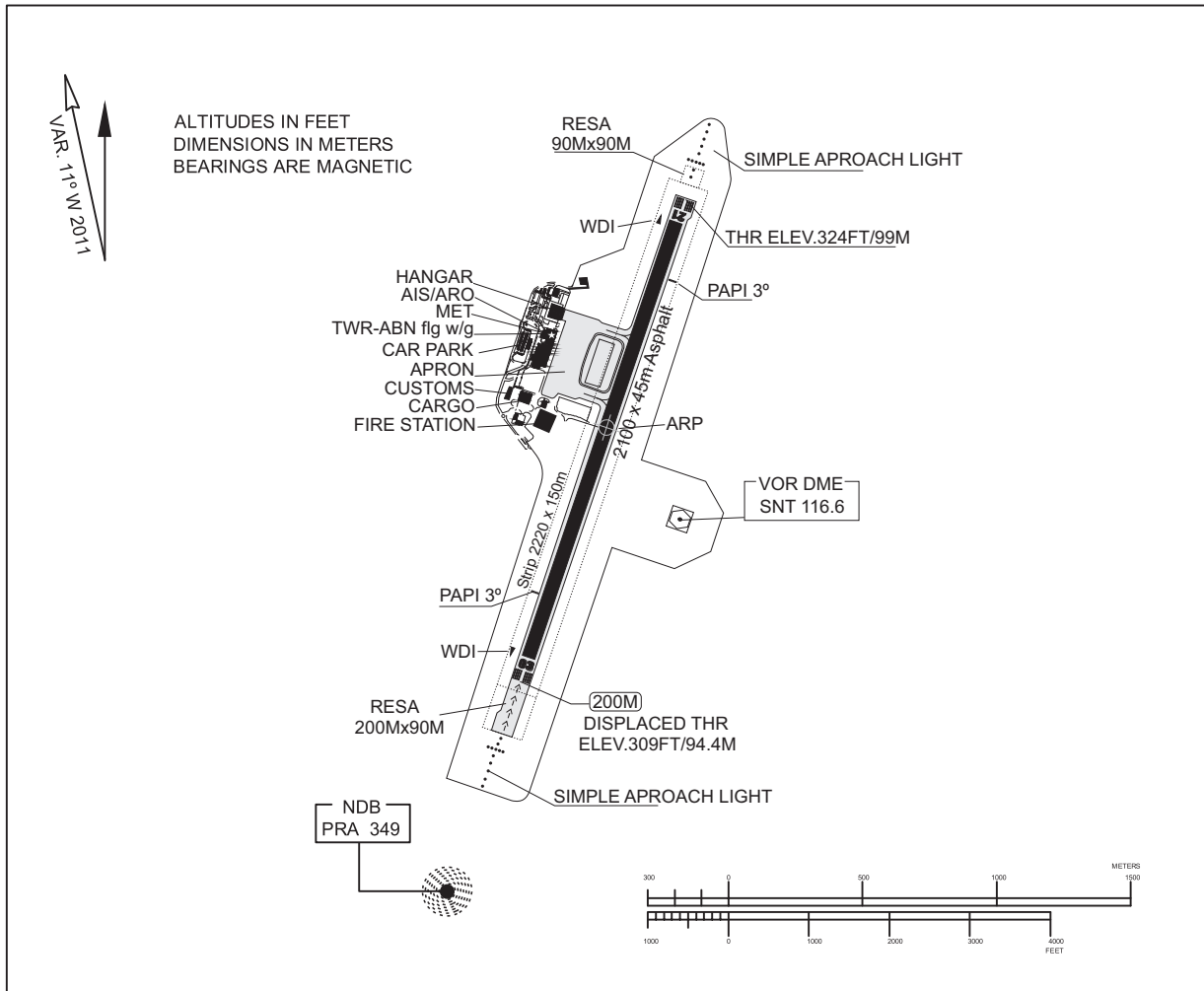

MARKING AIDS RWY 03-21 AND EXIT TWY

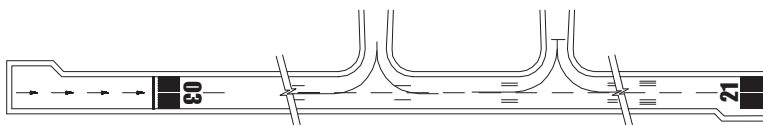

LIGHTING AIDS RWY 03-21 AND EXIT TWY

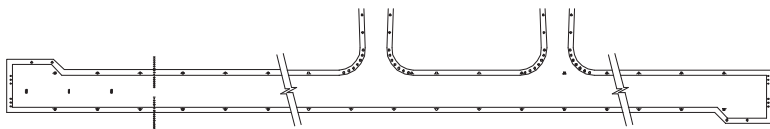

RWY	DIRECTION	THR	BEARING	STRENGTH	LIGHTING				
					RWY	PAPI	APPROACH	THRESHOLD	RUNWAY
03	022°GEO 033°MAG	14°56'02.43"N 023°29'15.56"W	PCN 49/F/B/X/U		03	3°	SIMPLE	RED	WHITE
21	202°GEO 213°MAG	14°56'59.75"N 023°28'51.77"W	PCN 49/F/B/X/U		21	3°	SIMPLE	RED	
					OTHERS : TAXIWAYS				
HELIPORT									

**AIRCRAFT PARKING / DOCKING  
CHART-ICAO**

**TWR 118.2  
APRON ELEV - 96M / 317 FT**

**AEROPORTO INTERNACIONAL  
DA PRAIA / NELSON MANDELA**

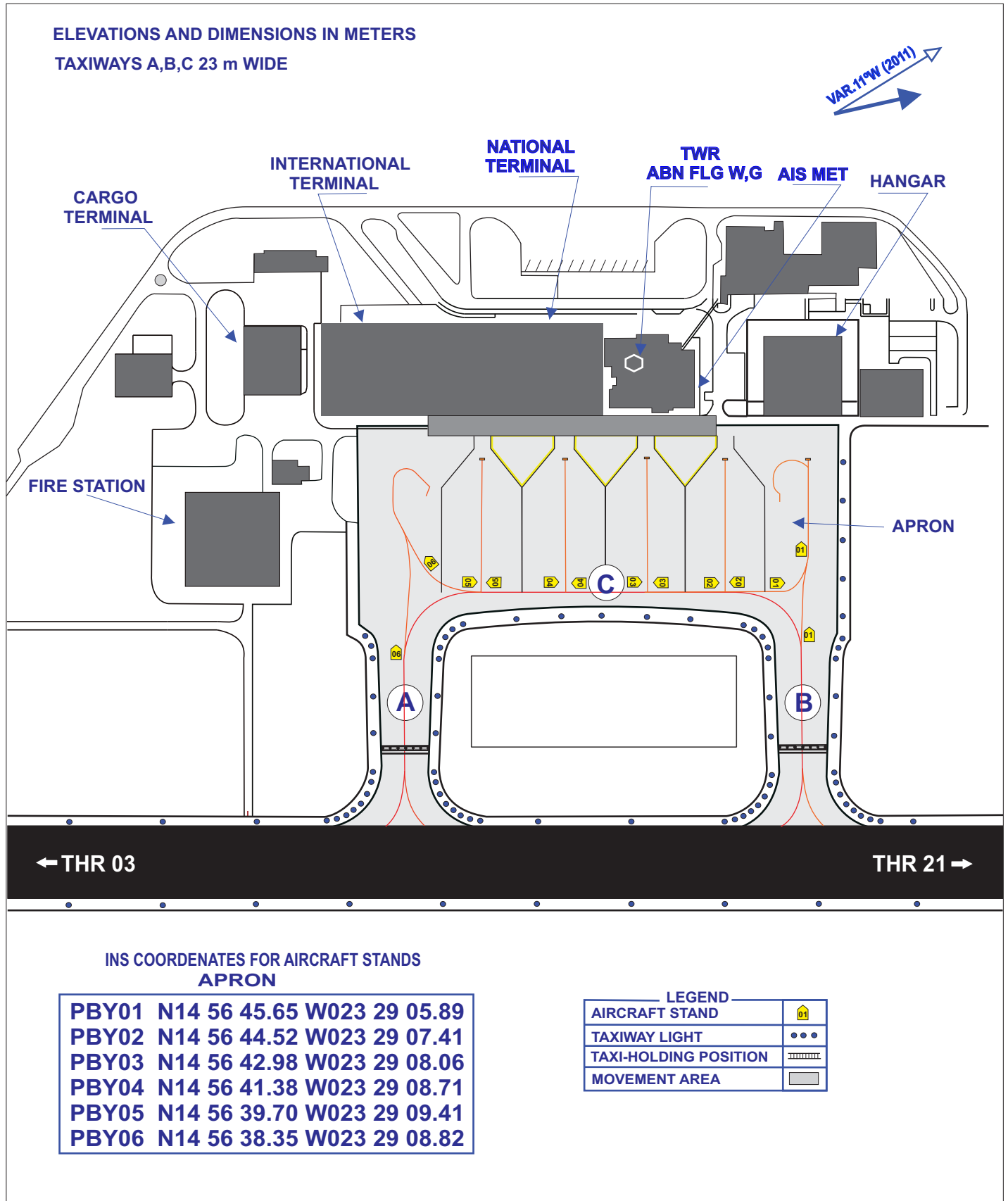

TYPE A CHART (OPERATING LIMITATIONS)

PRAIA AIRPORT INTL - NELSON MANDELA

RWY 03 - 21

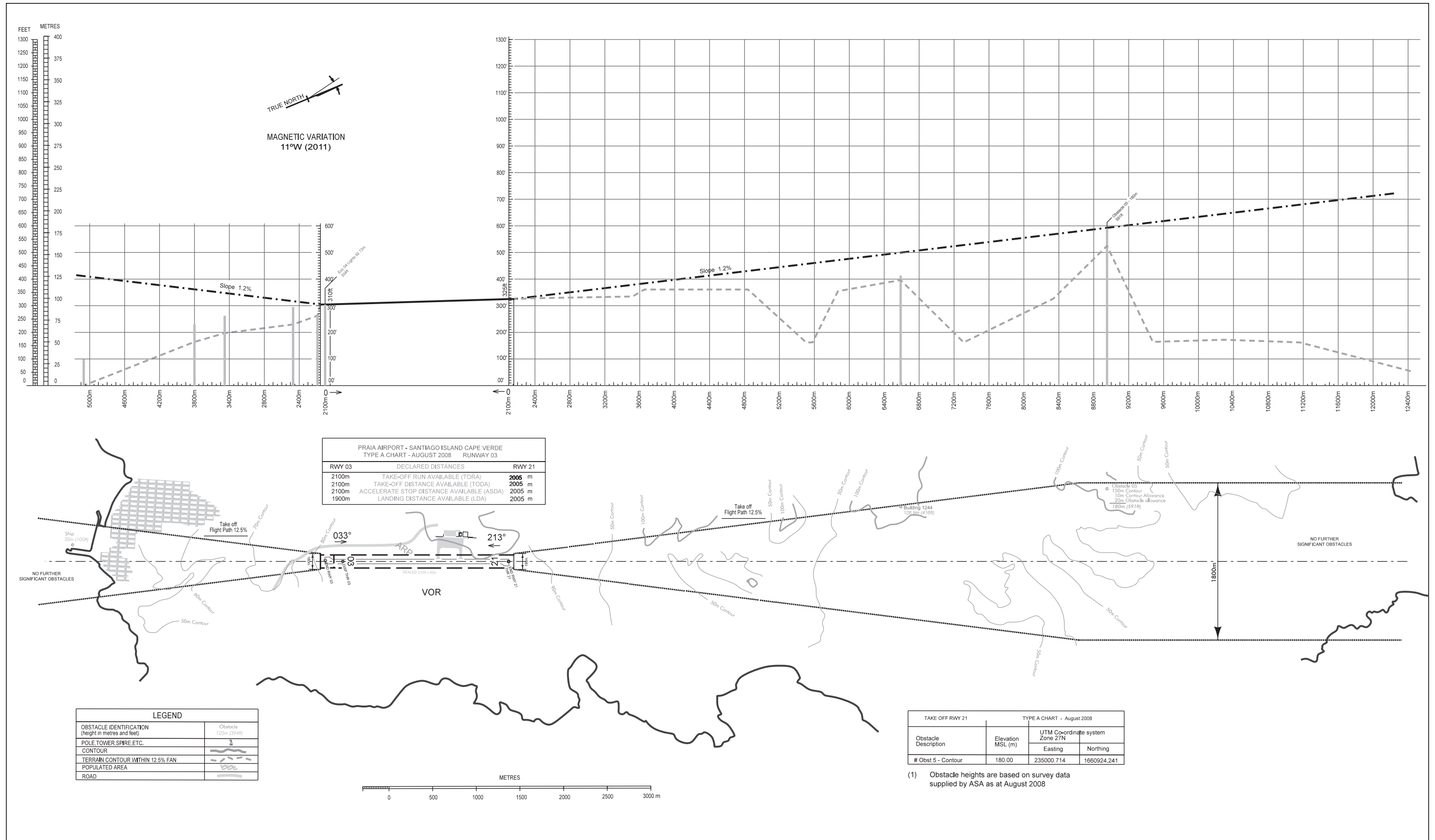

**STANDARD DEPARTURE  
CHART INSTRUMENT  
(SID) - ICAO**

TA: 7000'  
VAR: 11W

TWR - 118.200

**PRAIA AIRPORT  
GVNP  
RWY03**

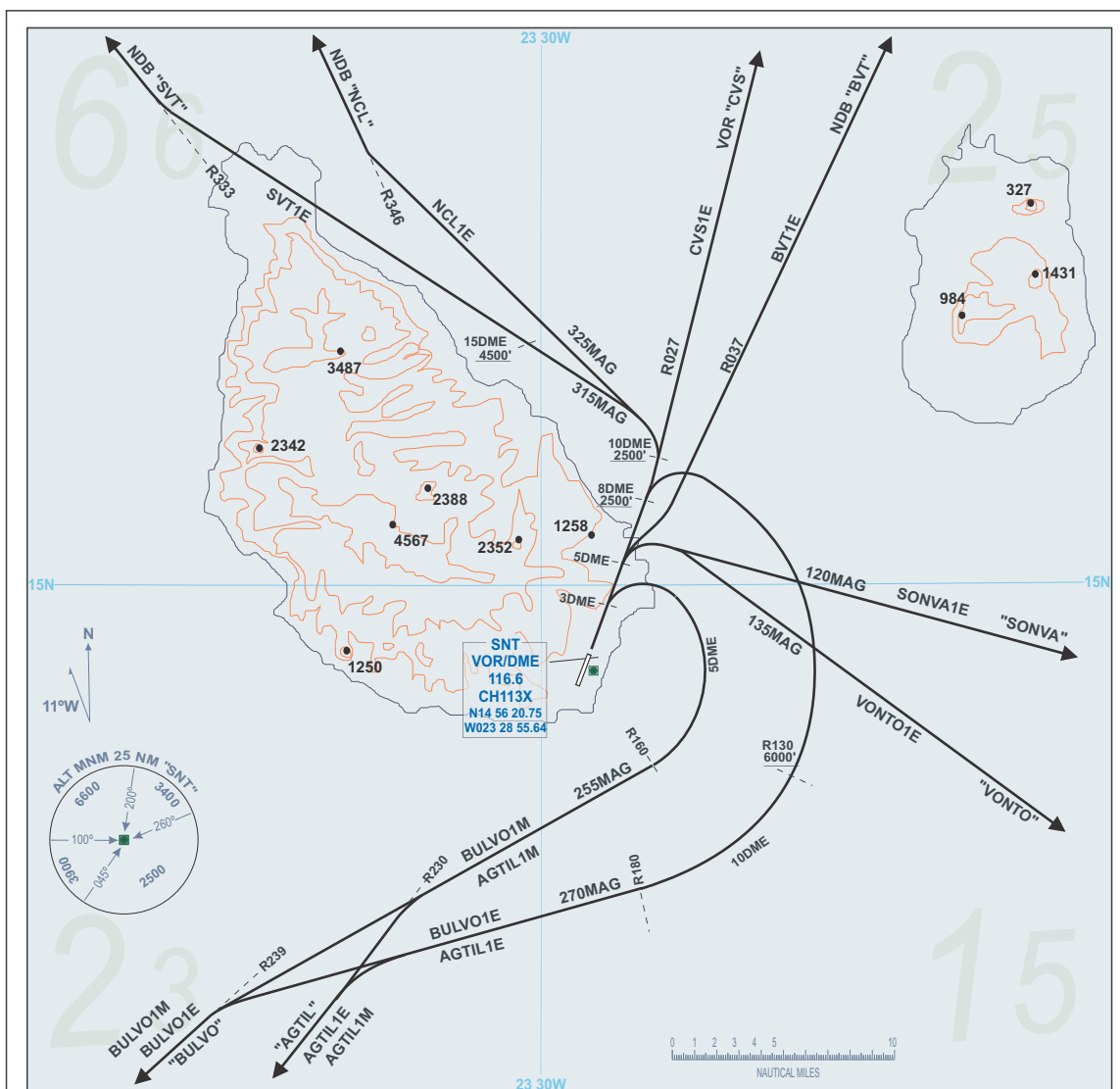

**AGTIL1E** : Climb on runway heading until passing 2500ft and 8DME/SNT. Turn right to join arc 10DME/SNT. Cross RDL130SNT at 6000ft or above. After crossing radial RDL180SNT follow track 270MAG to join RDL230SNT direct AGTIL.

**AGTIL1M** : Climb on runway heading until 3DME/SNT. Turn right to join arc 5DME/SNT. After crossing radial RDL160SNT follow track 255MAG to join RDL230SNT direct AGTIL.

**BULVO1E** : Climb on runway heading until passing 2500ft and 8DME/SNT. Turn right to join arc 10DME/SNT. Cross RDL130SNT at 6000ft or above. After crossing radial RDL180SNT follow track 270MAG to join RDL239SNT direct BULVO.

**BULVO1M** : Climb on runway heading until 3DME/SNT. Turn right to join arc 5DME/SNT. After crossing radial RDL160SNT follow track 255MAG to join RDL239SNT direct BULVO.

**BVT1E** : After departure turn right to join RDL037SNT direct BVT.

**CVS1E** : Climb on runway heading to join RDL027SNT direct CVS.

**NCL1E** : Climb on runway heading until passing 2500ft and 10DME/SNT. Turn left track 325MAG to join RDL346SNT direct NCL.

**SONVA1E** : Climb on runway heading until 5DME/SNT. Turn right track 120MAG to join RDL105SNT direct SONVA.

**SVT1E** : Climb on runway heading until passing 2500ft and 10DME/SNT then turn left track 315MAG to join RDL333SNT direct SVT. Cross 15DME/SNT above 4500ft.

**VONTO1E** : Climb on runway heading until 5DME/SNT. Turn right track 135MAG to join RDL121SNT direct VONTO.

**STANDARD DEPARTURE  
CHART INSTRUMENT  
(SID) - ICAO**

TA: 7000'  
VAR: 11W

TWR - 118.200

**PRAIA AIRPORT  
GVNP  
RWY 21**

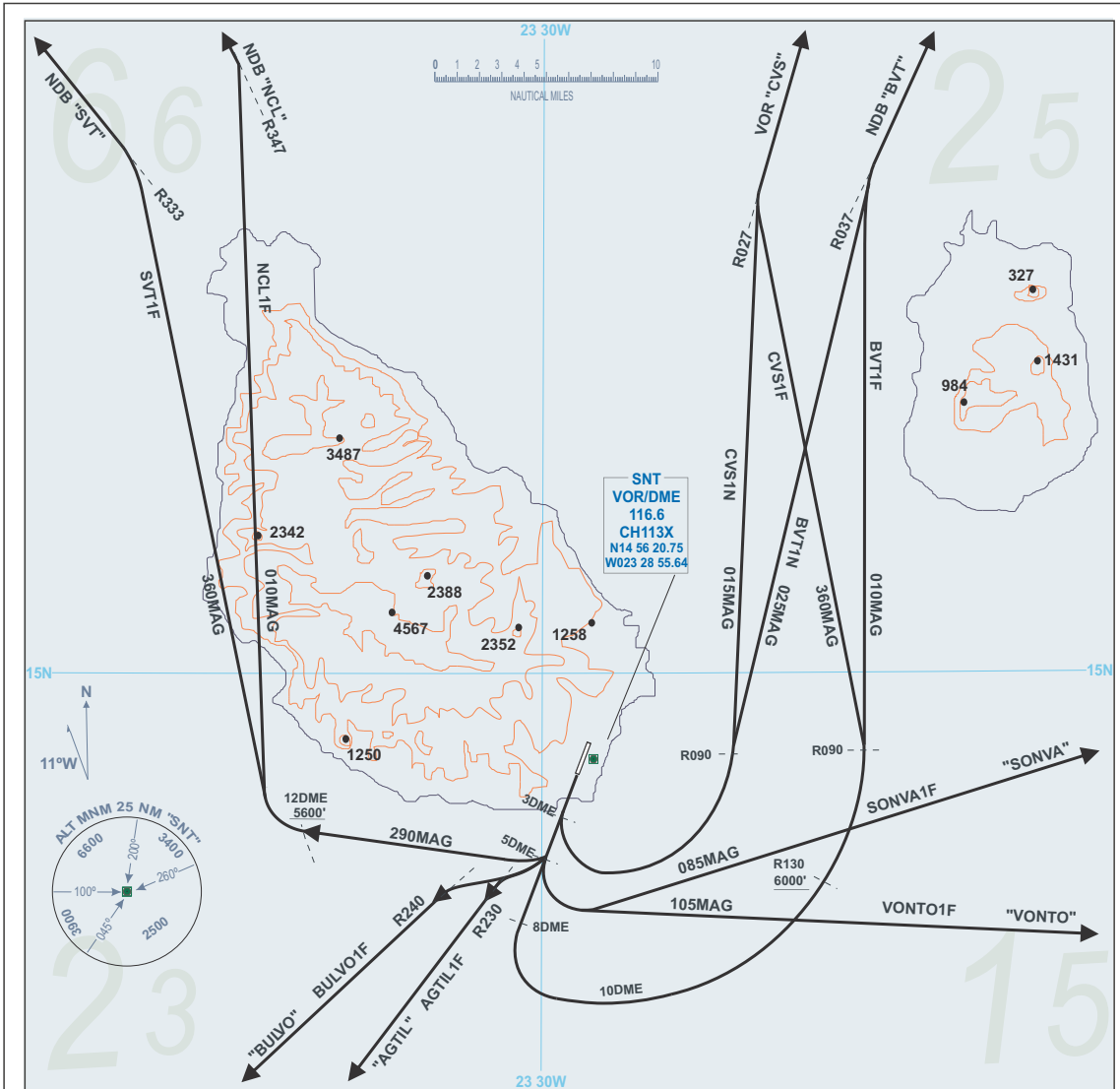

**AGTIL1F** : Climb on runway heading till 5DME/SNT. Turn right to join RDL230SNT direct AGTIL.

**BULVO1F** : Climb on runway heading till 5DME/SNT. Turn right to join RDL240SNT direct BULVO.

**BVT1F** : Climb on runway heading till 8DME/SNT. Turn left to join arc 10DME/SNT eastbound. Cross RDL130SNT at 6000 ft or above. After crossing RDL090SNT turn right track 010MAG to join RDL037SNT direct BVT.

**BVT1N** : Climb on runway heading till 3DME/SNT. Turn left to join arc 5DME/SNT eastbound. After crossing RDL090SNT turn right track 025MAG to join RDL037SNT direct BVT.

**CVS1F** : Climb on runway heading till 8DME/SNT. Turn left to join arc 10DME/SNT eastbound. Cross RDL130SNT at 6000 ft or above. After crossing RDL090SNT turn right track 360MAG to join RDL027SNT direct CVS.

**CVS1N** : Climb on runway heading till 3DME/SNT. Turn left to join arc 5DME/SNT eastbound. After crossing RDL090SNT turn right track 015MAG to join RDL027SNT direct CVS.

**NCL1F** : Climb on runway heading till 5DME/SNT. Turn right track 290MAG till passing 5600ft and 12DME/SNT. Turn right track 010MAG to join RDL347SNT direct NCL.

**SONVA1F** : Climb on runway till 5DME/SNT. Turn left track 085MAG to join RDL105SNT direct SONVA.

**SVT1F** : Climb on runway heading till 5DME/SNT. Turn right track 290MAG till passing 5600ft and 12DME/SNT. Turn right track 360MAG to join RDL333SNT direct SVT.

**VONTO1F** : Climb on runway heading till 5DME/SNT. Turn left track 105MAG to join RDL121SNT direct VONTO.

**STANDARD ARRIVAL  
CHART INSTRUMENT  
(STAR) - ICAO**

TA: 7000'  
VAR: 11W

TWR - 118.200

**PRAIA AIRPORT  
GVNP  
RWYs 03 & 21**

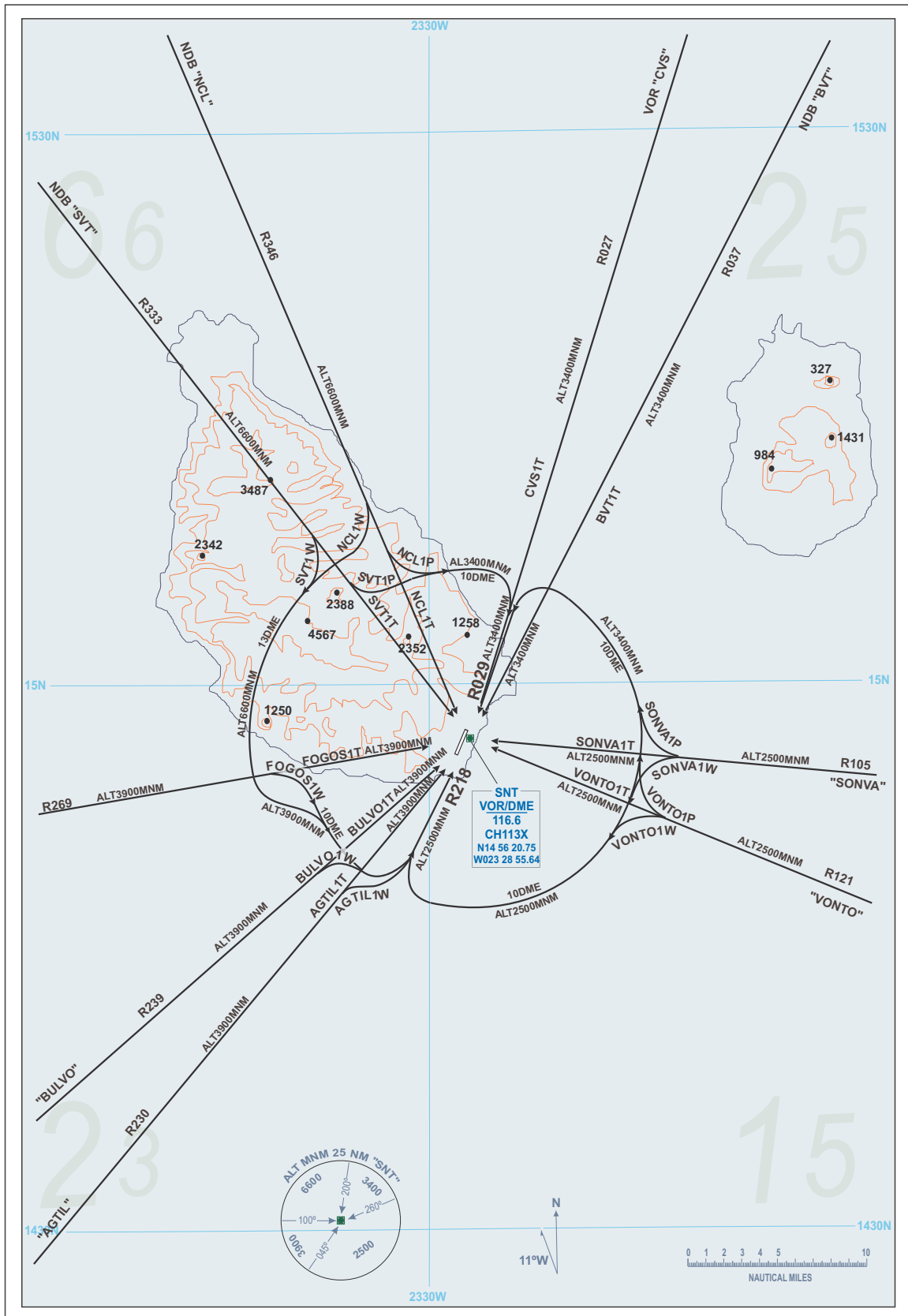

STANDARD ARRIVAL  
(STAR) - ICAO  
DESCRIPTION

PRAIA AIRPORT  
GVNP  
RWYs 03 & 21

**Note:** Minimum safe altitudes (MSA) are indicated for each leg. Except in case of emergency or loss of communications altitudes to maintain are those assigned by ATC. These must respect the indicated MSAs

**AGTIL1T** : Inbound RDL230SNT to overhead SNT MSA 3900ft. Expect a VOR/DME approach or request a visual contact approach.

**AGTIL1W** : Inbound RDL230SNT MSA 3900ft. At 12DME/SNT turn right to join RDL218SNT to overhead SNT MSA 2500ft. Expect a VOR/DME approach or request a visual contact approach.

**BULVO1T** : Inbound RDL239SNT to overhead SNT to overhead SNT MSA 3900ft. Expect a VOR/DME approach.

**BULVO1W** : Inbound RDL239SNT MSA 3900ft. At 12DME/SNT to join RDL218SNT to overhead SNT MSA 2500ft. Expect a VOR/DME approach or request a visual contact approach.

**BVT1T** : Inbound RDL037SNT MSA 3400ft to overhead SNT. Expect a VOR/DME approach or request a visual contact approach.

**CVS1T** : Inbound RDL027SNT MSA 3400ft. Expect a VOR/DME approach or request a visual contact approach.

**FOGOS1T** : Inbound RDL269SNT MSA 3900ft to overhead SNT. Expect a VOR/DME approach or request a visual contact approach.

**FOGOS1W** : Inbound RDL269SNT MSA 3900ft. At 12DME turn right to intercept and follow 10DME arc southbound MSA3900ft. Turn left into RDL218SNT to overhead SNT MSA 2500 ft. Expect a VOR/DME approach or request a visual contact approach.

**NCL1P** : Inbound RDL346SNT MSA 6600ft. At 12DME turn left to join 10DME arc eastbound MSA 3400ft. Turn right onto RDL029SNT MSA 3400ft to overhead SNT. Expect a VOR/DME approach or request a visual contact approach.

**NCL1T** : Inbound RDL346SNT to overhead SNT.

**NCL1W** : Inbound RDL346SNT MSA 6600ft. At 15DME turn right to join 13DME arc MSA 6600ft. After crossing RDL269SNT turn left to join arc 10DME/SNT MSA 3900ft. Turn left onto RDL218SNT to overhead SNT MSA 2500ft. Expect a VOR/DME approach or request a visual contact approach.

**SONVA1P** : Inbound RDL105SNT MSA 2500ft. At 12DME/SNT turn right to join arc10DME/SNT MSA 3400ft. Turn left into RDL029SNT to overhead SNT MSA 3400 ft. Expect a VOR/DME approach or request a visual contact approach.

**SONVA1T** : Inbound RDL105SNT MSA 2500ft to overhead SNT. Expect a VOR/DME approach or request a visual contact approach.

**SONVA1W** : Inbound RDL105SNT MSA 2500ft. At 12DME/SNT turn left to join arc 10DME/SNT MSA 2500ft. Turn right into RDL218SNT to overhead SNT MSA 2500 ft. Expect a VOR/DME approach or request a visual contact approach.

**SVT1P** : Inbound RDL333SNT MSA 6600ft. At 12DME turn left to join 10DME arc eastbound MSA 6600ft. After crossing RDL346SNT MSA 3400ft turn right into RDL029SNT to overhead SNT. Expect a VOR/DME approach or request a visual contact approach.

**SVT1T** : Inbound RDL333SNT MSA 6600ft to overhead SNT. Expect a VOR/DME approach or request a visual contact approach

**SVT1W** : Inbound RDL333SNT MSA 6600ft. At 15DME turn right to join 13DME arc MSA 6600ft. After crossing RDL269SNT turn left to join arc 10DME/SNT MSA 3900ft. Turn left onto RDL218SNT to overhead SNT MSA 2500ft. Expect a VOR/DME approach or request a visual contact approach.

**VONTO1P** : Inbound RDL121SNT MSA 2500ft. At 12DME/SNT turn right to join arc10DME/SNT MSA 3400ft. Turn left into RDL029SNT to overhead SNT MSA 3400ft. Expect a VOR/DME approach or request a visual contact approach.

**VONTO1T** : Inbound RDL121SNT MSA 2500ft to overhead SNT. Expect a VOR/DME approach or request a visual contact approach

**VONTO1W** : Inbound RDL121SNT MSA 2500ft. At 12DME/SNT turn left to join arc10DME/SNT MSA 2500ft. Turn right into RDL218SNT to overhead SNT MSA 2500ft. Expect a VOR/DME approach or request a visual contact approach



**INSTRUMENT**  
**APPROACH**  
**CHART - ICAO**

**AERODROME ELEV - 324 ft**  
**HEIGHTS RELATED TO**  
**DTHR RWY- 03 ELEV - 310 ft**

**TWR - 118.2**

**PRAIA / AEROPORTO DA PRAIA**  
**VOR/DME**  
**RWY 03**  
**ACFT CAT - A to D**

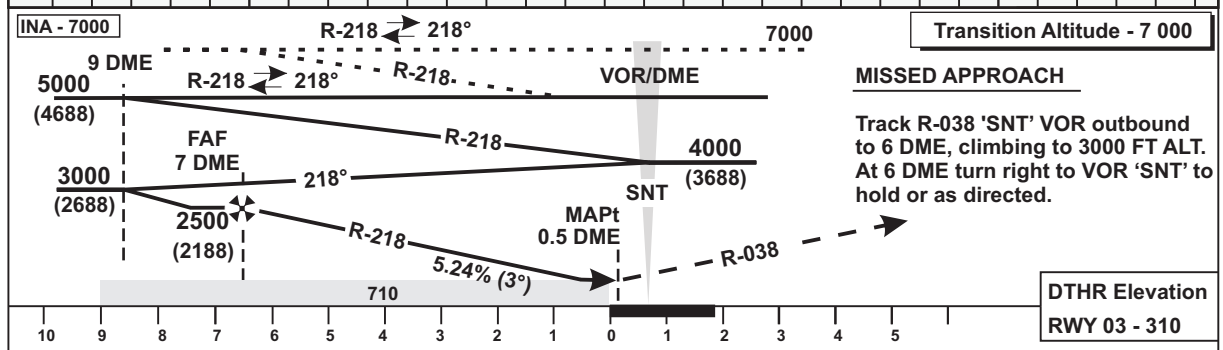
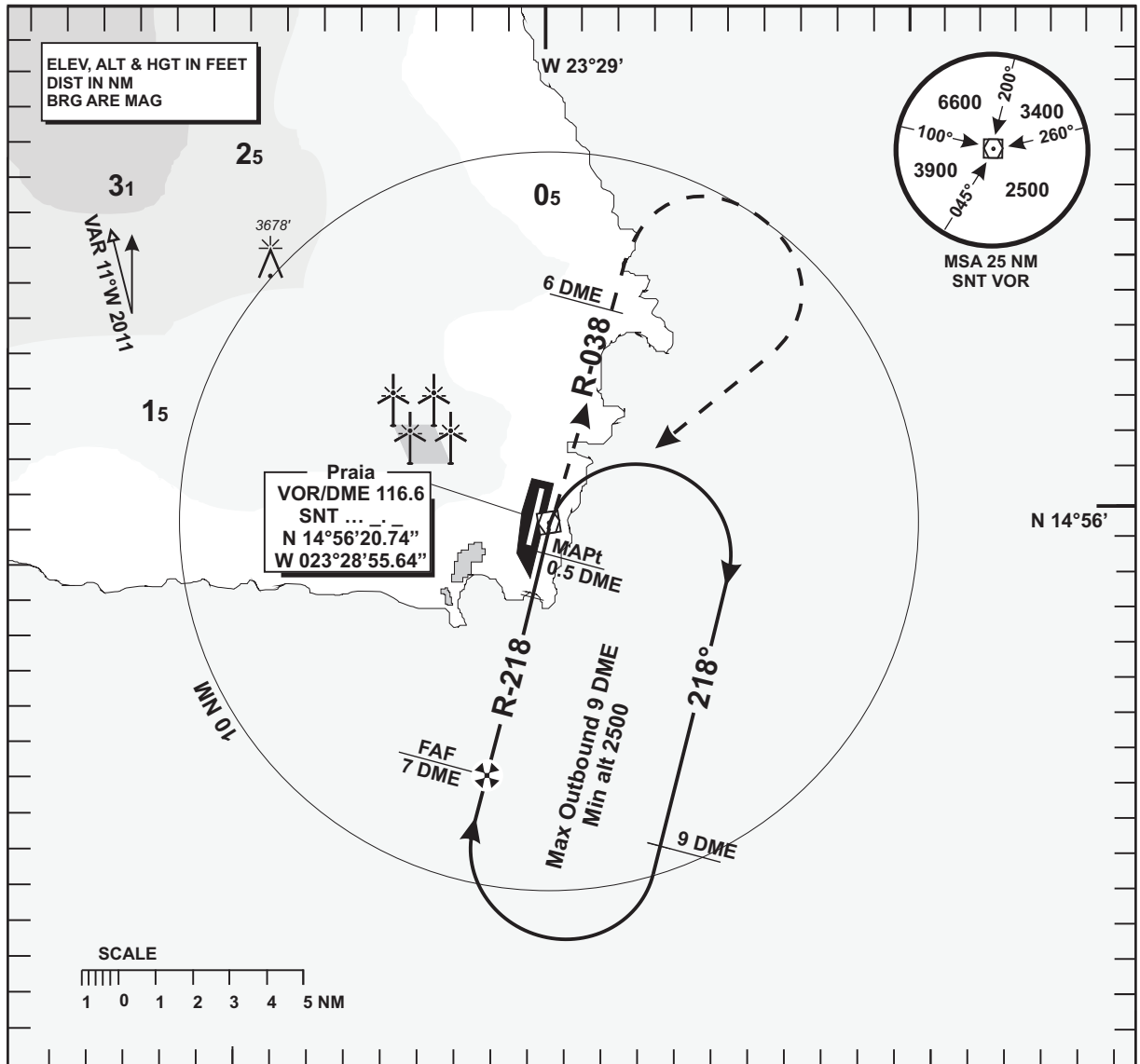

OCA(H)	A	B	C	D
STRAIGHT - IN APPROACH	710 (400)			
CIRCLING	790 (480)	830 (520)	930 (620)	1020 (710)

1. MAX 250 Kts IAS for the missed approach and communications failure procedures.  
2. Circle to land approach only allowed east of R-016 and R-219.

7 DME to THR							
Speed	KT	80	100	120	140	160	180
Time	min:s	4:57	3:58	3:18	2:50	2:29	2:12
RATE	ft/min	419	524	629	734	839	943

**INSTRUMENT  
APPROACH  
CHART - ICAO**

**AERODROME ELEV - 324 ft  
HEIGHTS RELATED TO  
DTHR RWY-03 ELEV - 310 ft**

**TWR - 118.2**

**PRAIA / AEROPORTO DA PRAIA**

**NDB  
RWY 03  
ACFT CAT - A & B**

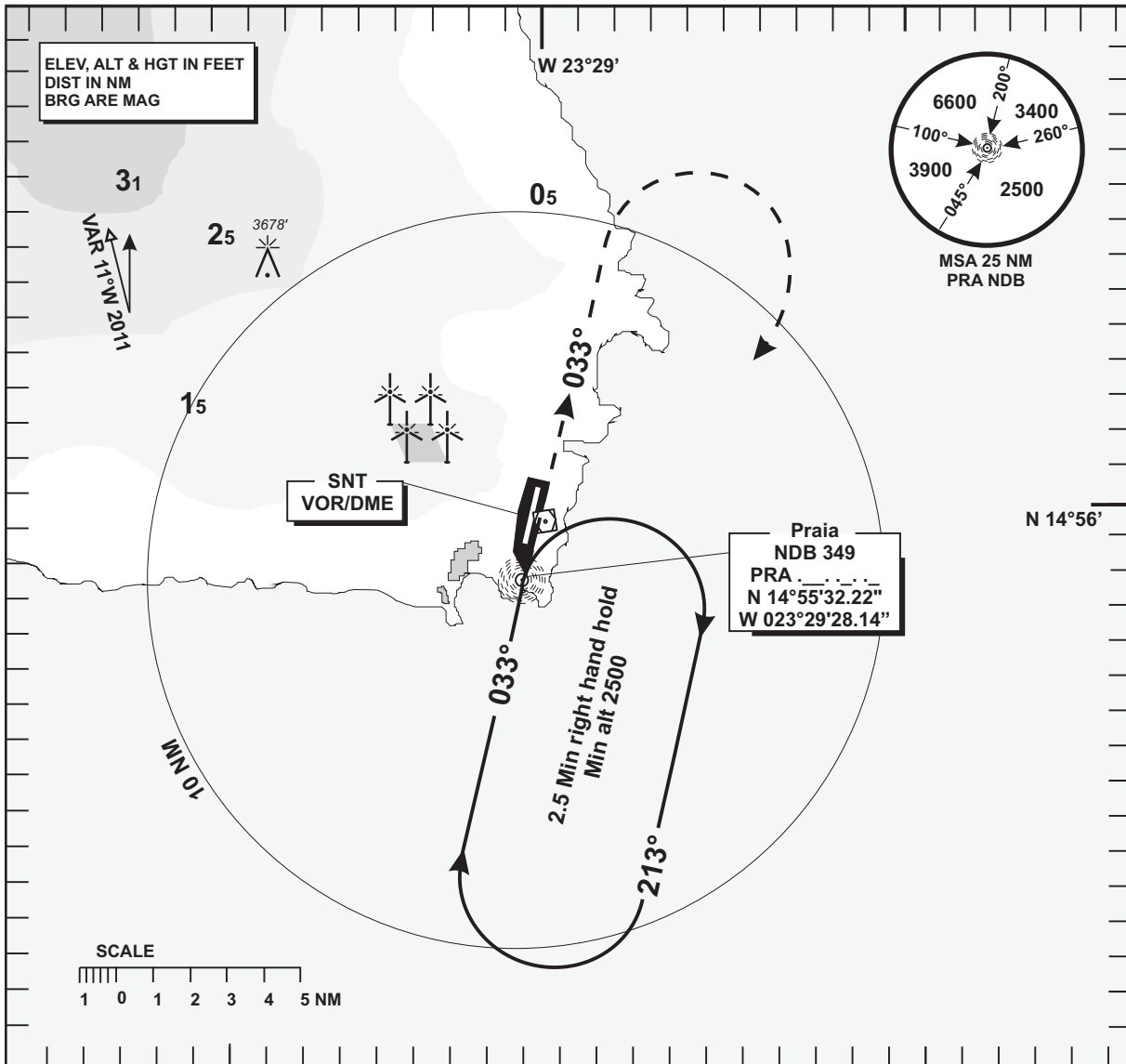

INA - 7000      033°      213°      NDB      7000      Transition Altitude - 7 000

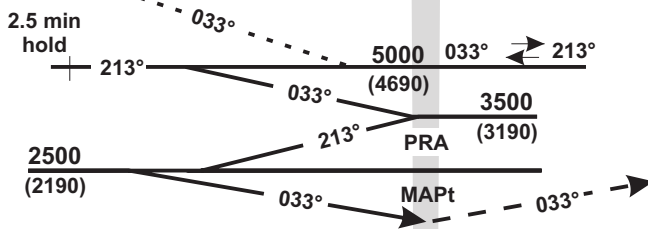

**MISSED APPROACH**

Track 033° climbing to 2000 FT ALT.  
At 2000 FT ALT turn right direct to  
NDB 'PRA' climbing to 2500 FT ALT  
to enter the hold or as directed.

**THR Elevation  
RWY 03 - 310**

OCA(H)	A	B	C	D	1. Circle to land approach only allowed east of QDM 039° and 197°. 2. Circle to land at the discretion of the pilot in command. 3. Timing not authorized to define the MAPt. 4. Turns before the MAPt prohibited.		
STRAIGHT - IN APPROACH	760 (450)						
CIRCLING	790 (480)	830 (520)	930 (620)	1020 (710)			
Speed	KT	80	100	120	140	160	180
Time	min:s						
RATE	ft/min						

**INSTRUMENT**  
**APPROACH**  
**CHART - ICAO**

**AERODROME ELEV - 324 ft**  
**HEIGHTS RELATED TO**  
**DTHR RWY- 03 ELEV - 310 ft**

**TWR - 118.2**

**PRAIA / AEROPORTO DA PRAIA**  
**NDB**  
**RWY 03**  
**ACFT CAT - C & D**

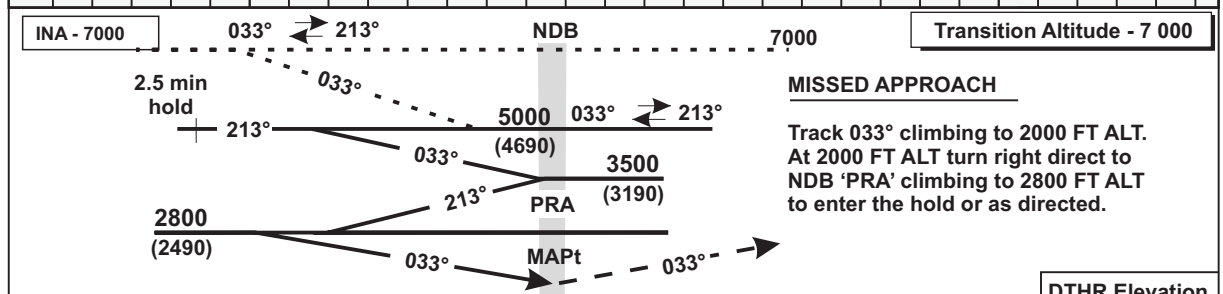
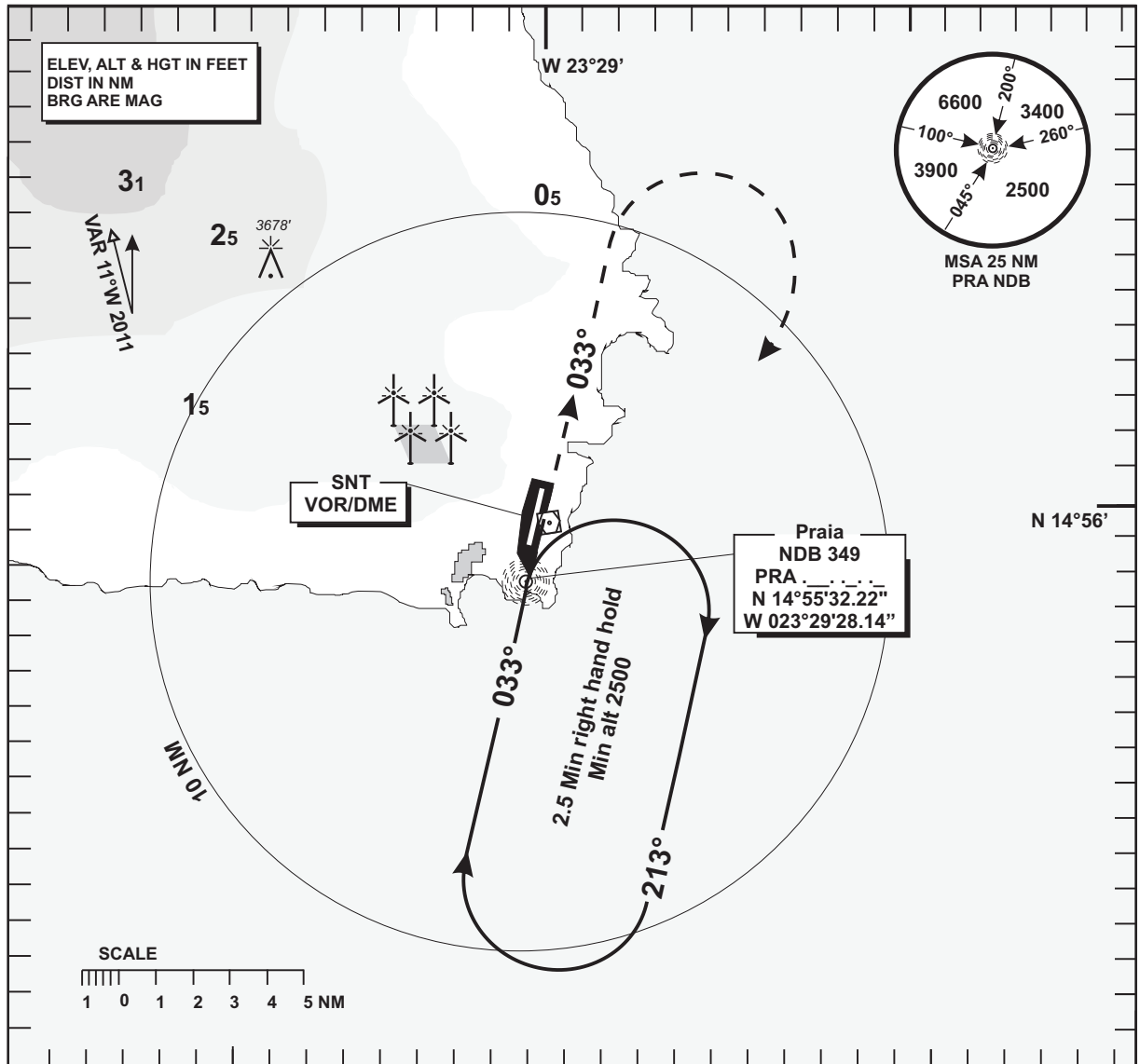

**MISSED APPROACH**

Track 033° climbing to 2000 FT ALT.  
At 2000 FT ALT turn right direct to  
NDB 'PRA' climbing to 2800 FT ALT  
to enter the hold or as directed.

**DTHR Elevation**  
**RWY 03 - 310**

OCA(H)	A	B	C	D
<b>STRAIGHT - IN APPROACH</b>	760 (450)			
<b>CIRCLING</b>	790 (480)	830 (520)	930 (620)	1020 (710)

<b>Speed</b>	<b>KT</b>	80	100	120	140	160	180
<b>Time</b>	<b>min:s</b>						
<b>RATE</b>	<b>ft/min</b>						

1. MAX 250 Kts IAS for the missed approach and communication failure procedures.
2. Circle to land approach only allowed east of QDM 039° and 197°.
3. Circle to land at the discretion of the pilot in command.
4. Timing not authorized to define the MAPt.
5. Turns before the MAPt prohibited.

**INSTRUMENT  
APPROACH  
CHART - ICAO**

**AERODROME ELEV - 324 ft  
HEIGHTS RELATED TO  
THR RWY- 21 ELEV - 324 ft**

**TWR - 118.2**

**PRAIA / AEROPORTO DA PRAIA**

**VOR/DME  
RWY 21  
ACFT CAT - A to D**

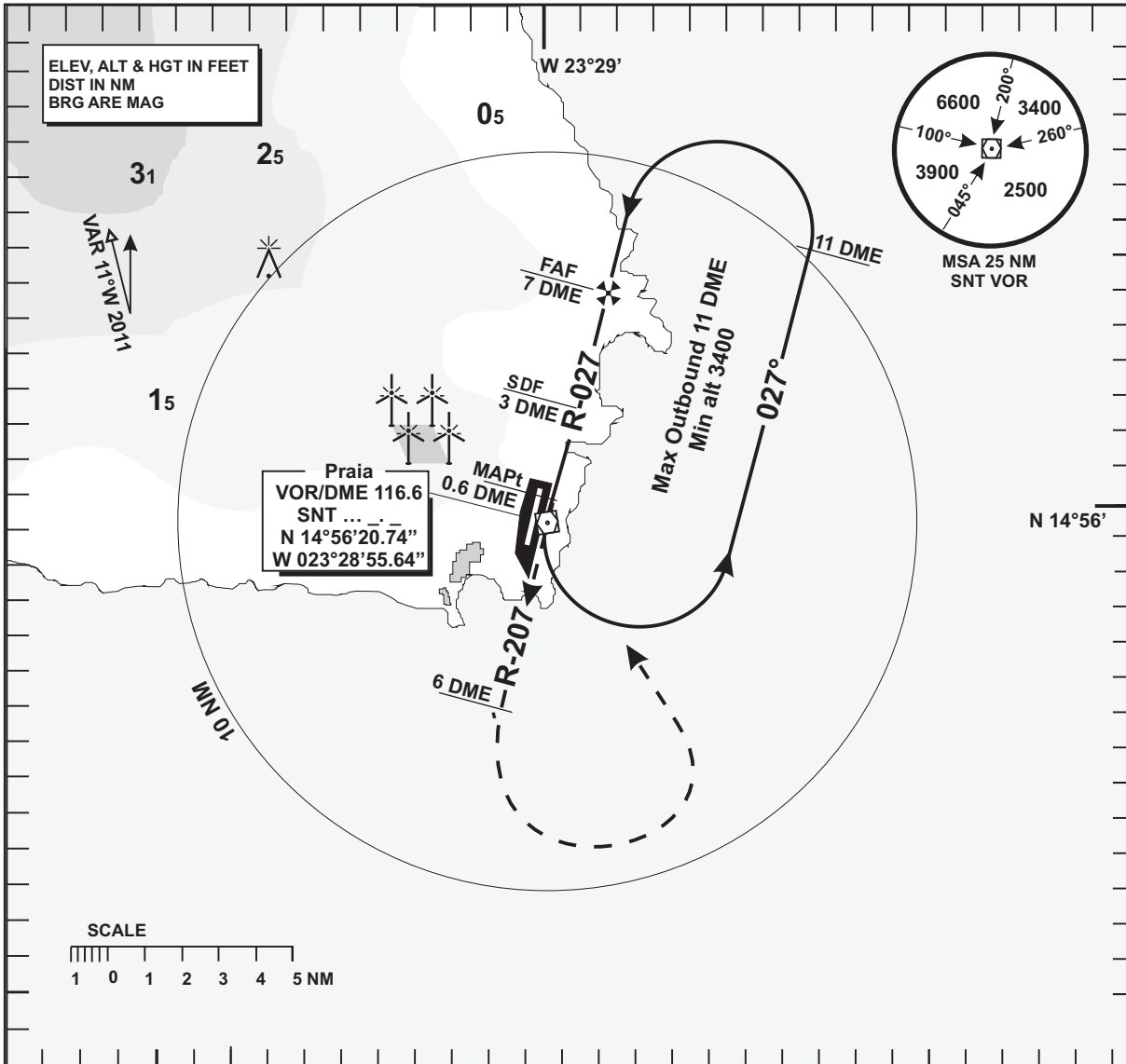

**INA - 7000** 7000 Transition Altitude - 7 000

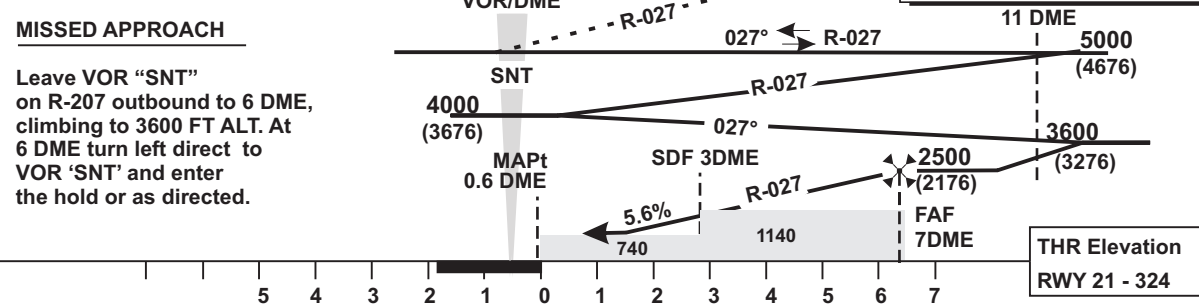

<b>OCA(H)</b>	<b>A</b>	<b>B</b>	<b>C</b>	<b>D</b>	<ol style="list-style-type: none"> <li>MAX 250 Kts IAS for the missed approach and communications failure procedure.</li> <li>Circle to land only allowed east of R-016 and R-219.</li> <li>Circle to land at the discretion of the pilot in command.</li> <li>Timing not authorized to define the MAPt.</li> <li>Turns before MAPt Prohibited.</li> </ol>
<b>STRAIGHT - IN APPROACH</b>	740 (416)				
<b>CIRCLING</b>	790 (466)	830 (506)	930 (606)	1020 (696)	

6 DME to THR							
Speed	KT	80	100	120	140	160	180
Time	min:s	4:46	3:49	3:11	2:44	2:23	2:07
Rate	ft/min	448	560	672	784	896	1008

**INSTRUMENT  
APPROACH  
CHART - ICAO**

**AERODROME ELEV - 324 ft  
HEIGHTS RELATED TO  
THR RWY- 21 ELEV - 324 ft**

**TWR - 118.2**

**PRAIA / AEROPORTO DA PRAIA  
NDB  
RWY 21  
ACFT CAT - A & B**

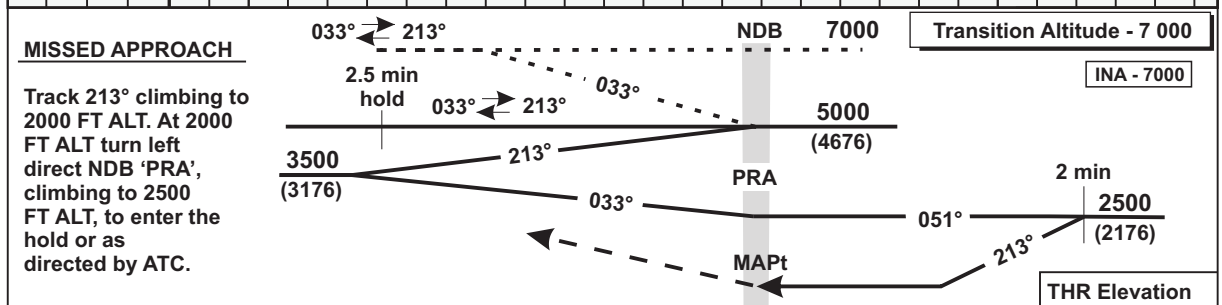
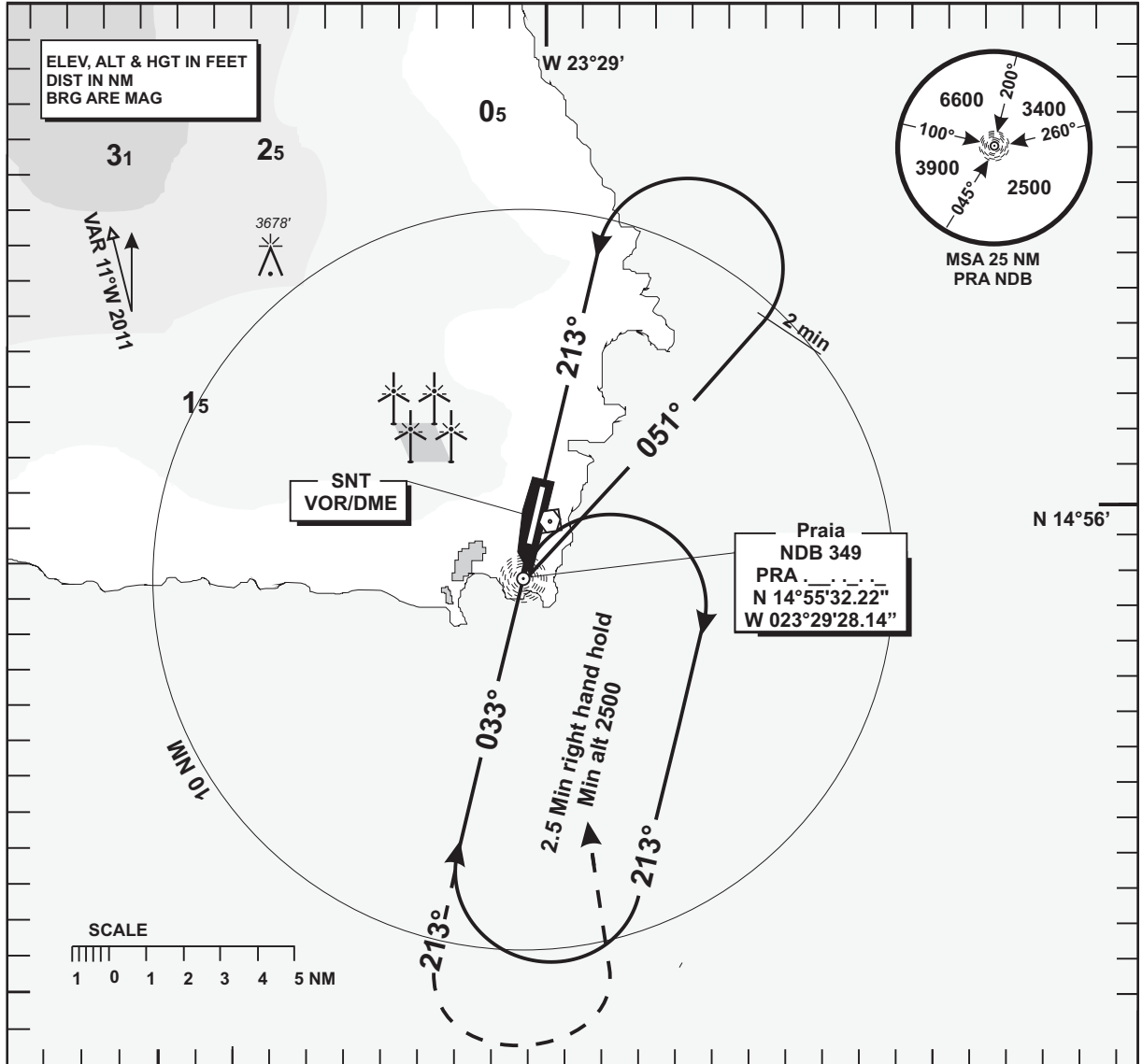

OCA(H)	A	B	C	D
STRAIGHT - IN APPROACH	NOT AUTHORISED			
CIRCLING	790 (466)	830 (506)	930 (606)	1020 (696)

1. Circle to land approach only allowed east of QDM 039° and 197°.
2. Circle to land at the discretion of the pilot in command.
3. Timing not authorised to define MAPt.
4. Turns before MAPt Prohibited.
5. Base-Turn only. 80°/260° turn Prohibited.

Speed	KT	80	100	120	140	160	180
Time	min:s						
RATE	ft/min						

**INSTRUMENT  
APPROACH  
CHART - ICAO**

**AERODROME ELEV - 324 ft  
HEIGHTS RELATED TO  
THR RWY- 21 ELEV - 324 ft**

**TWR - 118.2**

**PRAIA / AEROPORTO DA PRAIA**

**NDB  
RWY 21  
ACFT CAT - C & D**

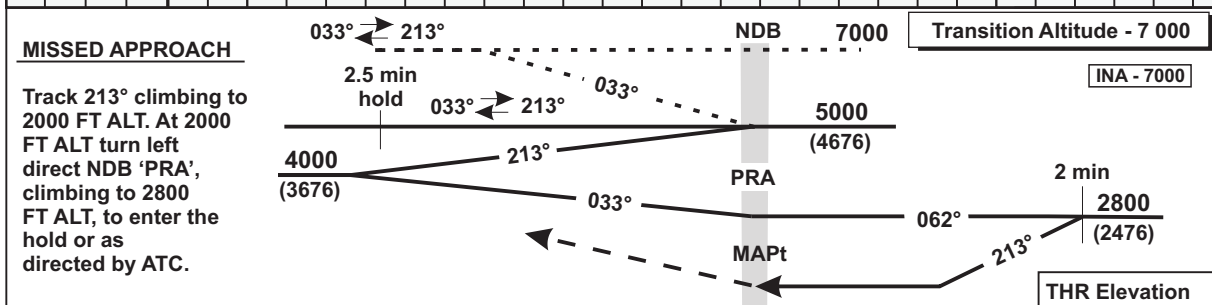
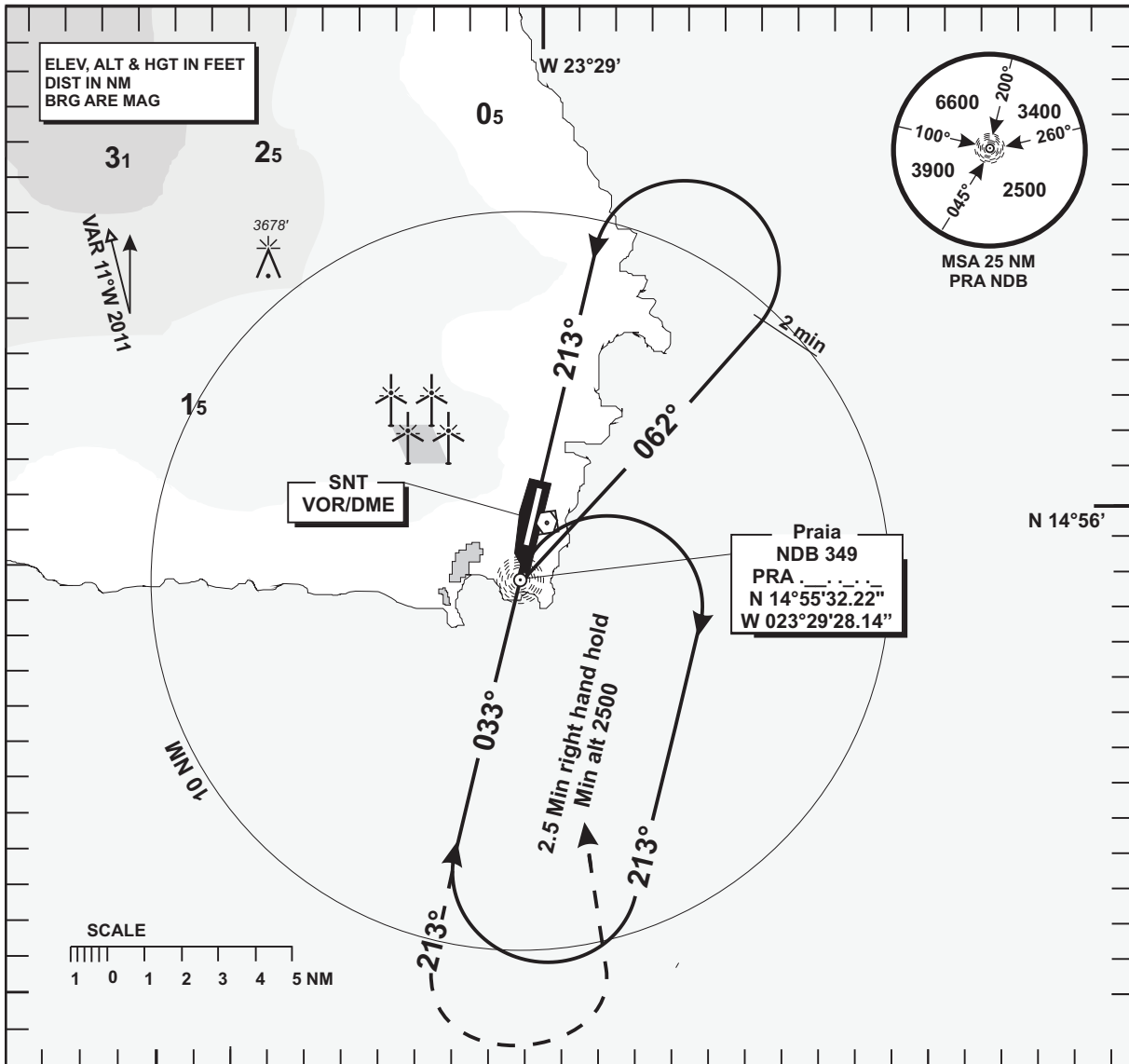

OCA(H)	A	B	C	D	1. MAX 250 Kts IAS for the missed approach and communications failure procedures. 2. Circle to land approach only allowed east of QDM 039° and 197°. 3. Circle to land at the discretion of the pilot in command. 4. Timing not authorised to define MAPt. 5. Turns before MAPt Prohibited. 6. Base-Turn only. 80°/260° turn Prohibited.			
STRAIGHT - IN APPROACH	NOT AUTHORISED							
CIRCLING	790 (466)	830 (506)	930 (606)	1020 (696)				
	Speed	KT	80	100	120	140	160	180
	Time	min:s						
	RATE	ft/min						

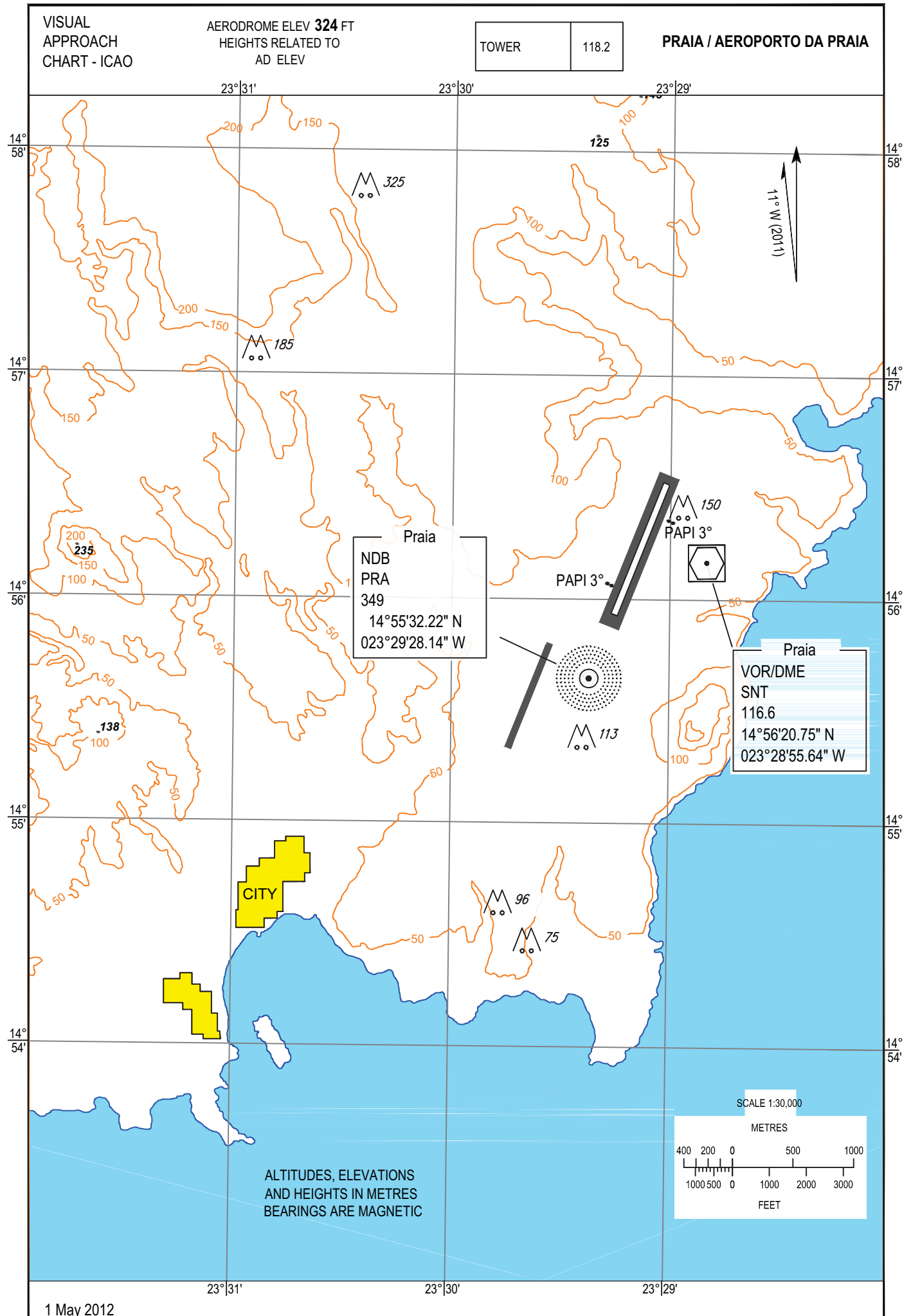

**INTENTIONALLY LEFT BLANK**



**GVSF AD 2.1 AERODROME LOCATION INDICATOR AND NAME**

GVSF - FOGO ISLAND / SAO FILIPE

**GVSF AD 2.2 AERODROME GEOGRAPHICAL AND ADMINISTRATIVE DATA**

1	ARP coordinates and site at AD	145309N 0242852W Midpoint of RWY 14 / 32
2	Direction and distance from city	2 KM SE of Sao Filipe
3	Elevation / Reference temperature / Mean low temperature	169 M (556 FT) / 30° C / NIL
4	Geoid Undulation at AD ELEV PSN	27 M (88 FT)
5	MAG VAR / Date of information / Annual change	10°W (2020) / 0.17° decreasing
6	AD operator, address, telephone, telefax, e-mail, AFS, website	ASA - Empresa Nacional de Aeroportos e Seguranca Aerea - S.A. Aeroporto de Sao Filipe Sao Filipe Fogo Island Republic of Cabo Verde TEL: +238 2812107 Telefax:+238 2812108 e-mail: adfogo@asa.cv AFS: NIL Http: NIL
7	Types of traffic permitted (IFR/VFR)	VFR
8	Remarks	NIL

**GVSF AD 2.3 OPERATIONAL HOURS**

1	AD operator	HO
2	Customs and immigration	NIL
3	Health and sanitation	NIL
4	AIS Briefing office	NIL
5	ATS Reporting office (ARO)	NIL
6	MET Briefing office	NIL
7	ATS	NIL
8	Fuelling	NIL
9	Handling	HO
10	Security	HO
11	De-icing	NIL
12	Remarks	NIL

**GVSF AD 2.4 HANDLING SERVICES AND FACILITIES**

1	Cargo handling facilities	NIL
2	Fuel / oil types	NIL
3	Fuelling facilities / capacity	NIL
4	De-icing facilities	NIL
5	Hangar space for visiting aircraft	NIL

6	<i>Repair facilities for visiting aircraft</i>	NIL
7	<i>Remarks</i>	NIL

#### GVSF AD 2.5 PASSENGER FACILITIES

1	<i>Hotel(s)</i>	In the city
2	<i>Restaurant(s)</i>	In the city
3	<i>Transportation</i>	Buses and taxis
4	<i>Medical facilities</i>	In the city
5	<i>Bank and Post office</i>	In the city
6	<i>Tourist office</i>	NIL
7	<i>Remarks</i>	NIL

#### GVSF AD 2.6 RESCUE AND FIRE FIGHTING SERVICES

1	<i>AD category for fire fighting</i>	CAT 5
2	<i>Rescue equipment</i>	NIL
3	<i>Capability for removal of disabled aircraft</i>	NIL
4	<i>Remarks</i>	NIL

#### GVSF AD 2.7 SEASONAL AVAILABILITY - CLEARING

1	<i>Type(s) of clearing equipment</i>	NIL
2	<i>Clearance priorities</i>	NIL
3	<i>Remarks</i>	NIL

#### GVSF AD 2.8 APRONS, TAXIWAYS AND CHECK LOCATIONS / POSITIONS DATA

1	<i>Apron designation, surface and strength</i>	Designation: APRON Surface: Asphalt Strength: 20 TON SIWL
2	<i>Taxiway designation, width, surface and strength</i>	Designation: TWY Width: 15 M Surface: Asphalt Strength: 20 TON SIWL
3	<i>Altimeter checkpoint location and elevation</i>	NIL
4	<i>VOR checkpoints</i>	NIL
5	<i>INS checkpoints</i>	NIL
6	<i>Remarks</i>	NIL

#### GVSF AD 2.9 SURFACE MOVEMENT GUIDANCE AND CONTROL SYSTEM AND MARKINGS

1	<i>Use of aircraft stand ID signs, TWY guide lines and visual docking / parking guidance system at aircraft stands</i>	Taxiing guidance signs at all intersections with TWY and RWY at all holding positions. Guidelines at APRON
2	<i>RWY and TWY markings and lights</i>	RWY: DESIG, THR, DTHR, TDZ and CL, marked TWY: CL and holding positions, marked

3	Stop bars and RWY guard lights	NIL
4	Other RWY protection measures	NIL
5	Remarks	NIL

**GVSF AD 2.10 AERODROME OBSTACLES**

<i>In Area 2</i>					
<i>OBST ID / Designation</i>	<i>OBST type</i>	<i>OBST position</i>	<i>ELEV / HGT</i>	<i>Markings / Type / Colour of lighting</i>	<i>Remarks</i>
<i>a</i>	<i>b</i>	<i>c</i>	<i>d</i>	<i>e</i>	<i>f</i>
NIL	NIL	NIL	NIL	NIL	NIL

<i>In Area 3</i>					
<i>OBST ID / Designation</i>	<i>OBST type</i>	<i>OBST position</i>	<i>ELEV / HGT</i>	<i>Markings / Type / Colour of lighting</i>	<i>Remarks</i>
<i>a</i>	<i>b</i>	<i>c</i>	<i>d</i>	<i>e</i>	<i>f</i>
NIL	NIL	NIL	NIL	NIL	NIL

To be developed.

**GVSF AD 2.11 METEOROLOGICAL INFORMATION PROVIDED**

1	Associated MET office	Aeronautical MET Station
2	Hours of service MET office outside hours	07:00 - 19:00 NIL
3	Office responsible for TAF preparation Periods of validity Interval of issuance	NIL NIL NIL
4	Availability of TREND forecast Interval of issuance	NIL
5	Briefing / Consultation provided	Self-briefing or telephone
6	Flight documentation Language(s) used	NIL NIL
7	Charts and other information displayed or available for briefing or consultation	NIL
8	Supplementary equipment available for providing information	AWOS: Surface wind for RWY 14, temperature, dew point relative humidity and altimeter setting.
9	ATS units provided with information	SAO FILIPE INFO (AFIS); SAL APP and SAL ACC
10	Additional information (Limitation of service, etc.)	MET Observer on duty in own space

**GVSF AD 2.12 RUNWAY PHYSICAL CHARACTERISTICS**

<i>Designations RWY NR</i>	<i>True BRG</i>	<i>Dimensions of RWY(M)</i>	<i>Strength (PCN) &amp; surface of RWY and SWY</i>	<i>THR coordinates RWY end coordinates THR geoid undulation</i>	<i>THR elevation and highest elevation of TDZ of precision APP RWY</i>
<i>1</i>	<i>2</i>	<i>3</i>	<i>4</i>	<i>5</i>	<i>6</i>
14	130.45°	1350 X 30	20 TON SIWL	145322.63N 0242907.80W 145257.30N 0242837.27W NIL	168 M / 551 FT NIL

Designations RWY NR	True BRG	Dimensions of RWY(M)	Strength (PCN) & surface of RWY and SWY	THR coordinates RWY end coordinates THR geoid undulation	THR elevation and highest elevation of TDZ of precision APP RWY
1	2	3	4	5	6
32	310.45°	1350 X 30	20 TON SIWL	145257.30N 0242837.27W 145322.63N 0242907.80W NIL	168 M / 552 FT NIL

Slope of RWY-SWY	SWY dimensions (M)	CWY dimensions (M)	Strip dimensions (M)	RWY end safety area (M)	Location / description of arresting system	OFZ	Remarks
7	8	9	10	11	12	13	14
NIL	NIL	NIL	1320 X 80	90 X 60	NIL	NIL	NIL
NIL	NIL	NIL	1320 X 80	90 X 60	NIL	NIL	NIL

#### GVSF AD 2.13 DECLARED DISTANCES

RWY Designator	TORA (M)	TODA (M)	ASDA (M)	LDA (M)	Remarks
1	2	3	4	5	6
14	1350	1350	1350	1200	DTHR 150 M
32	1350	1350	1350	1200	DTHR 150 M

#### GVSF AD 2.14 APPROACH AND RUNWAY LIGHTING

RWY Designator	APCH LGT type LEN INTST	THR LGT colour WBAR	VASIS (MEHT) PAPI	TDZ LGT LEN	RWY CL LGT LEN, spacing, colour, INTST	RWY edge LGT LEN, spacing, colour INTST	RWY end LGT colour WBAR	SWY LGT LEN colour	Remarks
1	2	3	4	5	6	7	8	9	10
14	NIL	NIL	NIL	NIL	NIL	NIL	NIL	NIL	NIL
32	NIL	NIL	NIL	NIL	NIL	NIL	NIL	NIL	NIL

#### GVSF AD 2.15 OTHER LIGHTING SECONDARY POWER SUPPLY

1	ABN / IBN location, characteristics and hours of operation	NIL
2	LDI / Anemometer location and LGT	NIL
3	TWY ledge and CL lighting	NIL
4	Secondary power supply / switch - over time	NIL
5	Remarks	NIL

#### GVSF AD 2.16 HELICOPTER LANDING AREA

1	Coordinates TLOF or THR of FATO Geoid undulation	NIL
2	TLOF and / or FATO elevation M / FT	NIL
3	TLOF and FATO area dimensions, surface, strength, marking	NIL
4	True BRG of FATO	NIL
5	Declared distance available	NIL
6	APP and FATO lighting	NIL

7	Remarks	Use the RWY
---	---------	-------------

**GVSF AD 2.17 ATS AIRSPACE**

1	Designation and lateral limits	SAO FILIPE ATZ Circle with a radius of 5 NM centred on 145309N 0242852W (Fogo Island / Sao Filipe ARP)
2	Vertical limits	GND / MSL - 2000 FT
3	Airspace classification	Class G
4	ATS unit call sign Language(s)	SANFILIPE INFORMATION (AFIS) English, Portuguese
5	Transition altitude	NIL
6	Hours of applicability	H24
7	Remarks	Service provided: AFIS

**GVSF AD 2.18 ATS COMMUNICATION FACILITIES**

Service designation	Call sign	Channel(s)	SATVOICE number(s)	Logon address	Hours of operation	Remarks
1	2	3	4	5	6	7
AFIS	SANFILIPE INFORMATION	118.600 MHZ	NIL	NIL	H24	NIL

**GVSF AD 2.19 RADIO NAVIGATION AND LANDING AIDS**

Type of aid, MAG VAR Type of supported OPS (For VOR / ILS give declination)	ID	Frequency(ies) Channel number(s) service provider RPI	Hours of operation	Position of transmitting antenna coordinates	Elevation of the transmitting antenna of DME, GBAS reference point	Service volume radius from GBAS reference point	Remarks
1	2	3	4	5	6	7	8
NIL	NIL	NIL	NIL	NIL	NIL	NIL	NIL

**GVSF AD 2.20 LOCAL TRAFFIC REGULATIONS**

**1. Aerodrome regulations**

NIL

**6. Taxiing - Limitations**

NIL

**2. Taxiing to and from stands**

Arriving aircraft will be allocated a parking position by the marshaller and will always be guided by his assistant.

**7. School and training flights - Technical test flights - Use of runways**

NIL

**3. Parking area for small aircraft (general aviation)**

NIL

**8. Helicopter traffic - Limitations**

NIL

**4. Parking area for helicopters**

NIL

**9. Removal of disabled aircraft from runways**

NIL

**5. Apron - Taxiing during winter conditions**

NIL

**GVSF AD 2.21 NOISE ABATEMENT PROCEDURES**

NIL

**GVSF AD 2.22 FLIGHT PROCEDURES**

NIL

**GVSF AD 2.23 ADDITIONAL INFORMATION**

NIL

**GVSF AD 2.24 CHARTS RELATED TO AN AERODROME**

*Chart name*

*Page*

---

AERODROME CHART - ICAO

GVSF AD 2-7

VISUAL APPROACH CHART - ICAO

GVSF AD 2-8

**AERODROME  
CHART**

145309N  
0242852W AD Elev.169m/556Ft

AFIS 118.6

**FOGO ISLAND  
SAO FILIPE**

ALTITUDES, ELEVATION  
AND HEIGHTS IN METRES  
BEARINGS ARE MAGNETIC

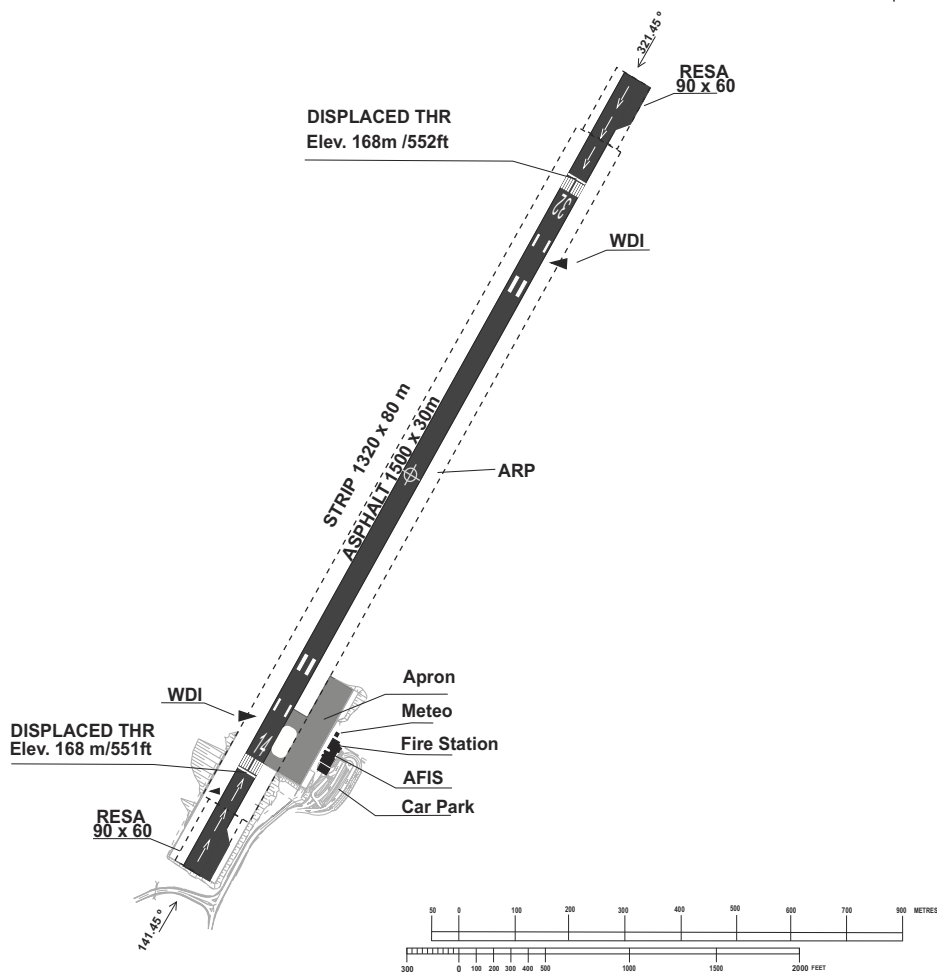

NEW CHART

RWY	DIRECTION	THR	BEARING STRENGTH	DECLARED DISTANCES				
				RWY	TORA	TODA	ASDA	LDA
14	141.45°	14°53 22.63 N 024°29 07.80W	20 TON SIWL	14	1350	1350	1350	1200
32	321.45°	14°52 57.30 N 024°28 37.27 W	20 TON SIWL	32	1350	1350	1350	1200
HELIPORT				OTHER:				

# VISUAL APPROACH CHART

145309N  
0242852W AD Elev.169m/556Ft

AFIS 118.6

FOGO ISLAND  
SAO FILIPE

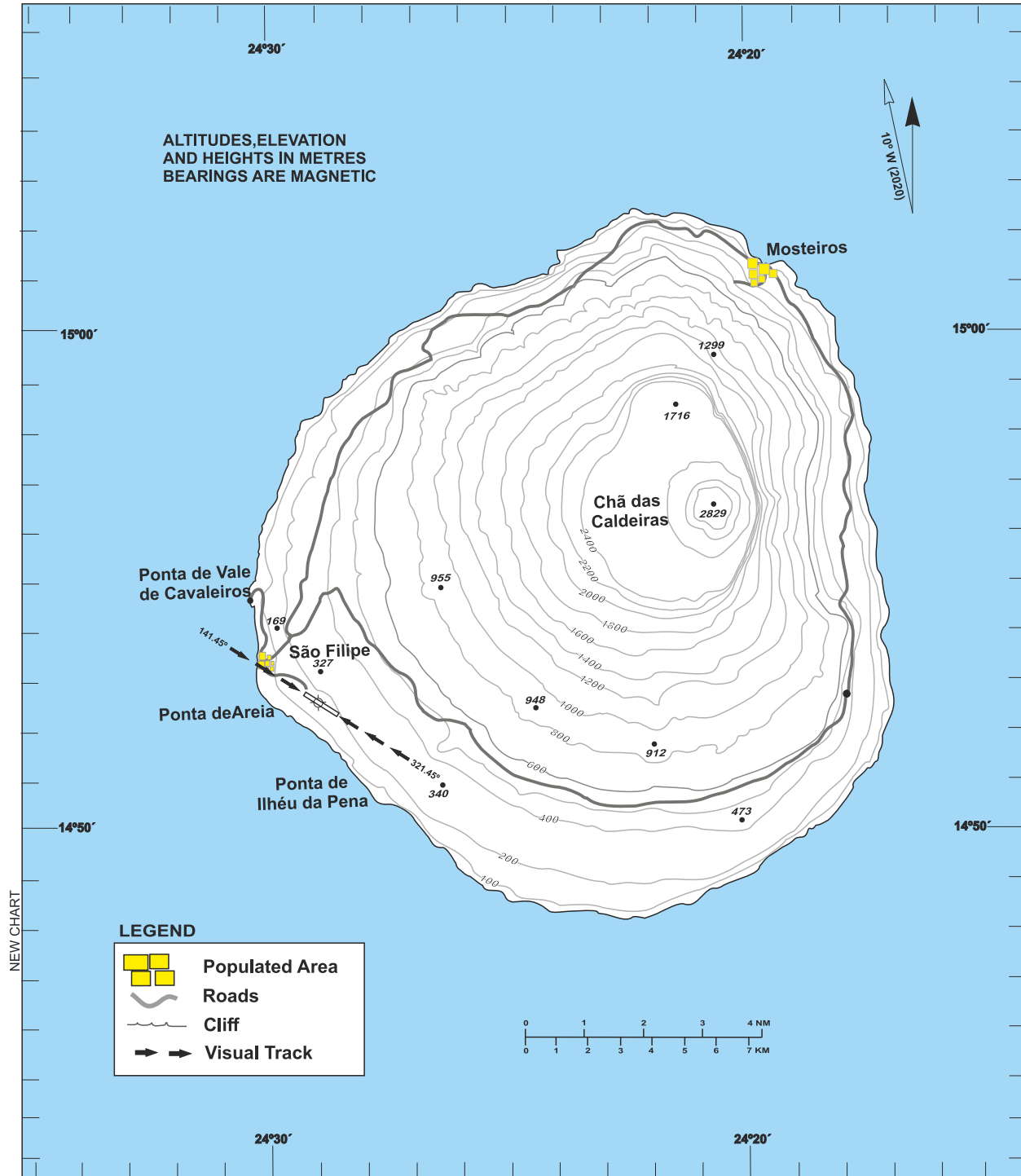



**GVSN AD 2.1 AERODROME LOCATION INDICATOR AND NAME**

GVSN - SAO NICOLAU ISLAND / PREGUICA

**GVSN AD 2.2 AERODROME GEOGRAPHICAL AND ADMINISTRATIVE DATA**

1	ARP coordinates and site at AD	163521N 0241702W Midpoint of RWY 01 / 19
2	Direction and distance from city	5 KM S of Ribeira Brava
3	Elevation / Reference temperature / Mean low temperature	181 M (594 FT) / 30 C° / NIL
4	Geoid Undulation at AD ELEV PSN	29 M (95 FT)
5	MAG VAR / Date of information / Annual change	9°W (2020) / 0.18° decreasing
6	AD operator, address, telephone, telefax, e-mail, AFS, website	ASA - Empresa Nacional de Aeroportos e Seguranca Aerea - S.A. Aeroporto da Pregoica Pregoica Sao Nicolau Island Republic of Cabo Verde TEL: +238 2351313 +238 2351954 Telefax:+238 2351500 e-mail: afis.sne@asa.cv AFS: NIL Http: NIL
7	Types of traffic permitted (IFR/VFR)	VFR
8	Remarks	NIL

**GVSN AD 2.3 OPERATIONAL HOURS**

1	AD operator	HO
2	Customs and immigration	NIL
3	Health and sanitation	NIL
4	AIS Briefing office	NIL
5	ATS Reporting office (ARO)	NIL
6	MET Briefing office	NIL
7	ATS	NIL
8	Fuelling	NIL
9	Handling	HO
10	Security	HO
11	De-icing	NIL
12	Remarks	NIL

**GVSN AD 2.4 HANDLING SERVICES AND FACILITIES**

1	Cargo handling facilities	NIL
2	Fuel / oil types	NIL
3	Fuelling facilities / capacity	NIL
4	De-icing facilities	NIL
5	Hangar space for visiting aircraft	NIL

6	<i>Repair facilities for visiting aircraft</i>	NIL
7	<i>Remarks</i>	NIL

#### GVSN AD 2.5 PASSENGER FACILITIES

1	<i>Hotel(s)</i>	In town
2	<i>Restaurant(s)</i>	In town
3	<i>Transportation</i>	Buses and taxis
4	<i>Medical facilities</i>	In town
5	<i>Bank and Post office</i>	In town
6	<i>Tourist office</i>	NIL
7	<i>Remarks</i>	NIL

#### GVSN AD 2.6 RESCUE AND FIRE FIGHTING SERVICES

1	<i>AD category for fire fighting</i>	CAT 5
2	<i>Rescue equipment</i>	NIL
3	<i>Capability for removal of disabled aircraft</i>	NIL
4	<i>Remarks</i>	NIL

#### GVSN AD 2.7 SEASONAL AVAILABILITY - CLEARING

1	<i>Type(s) of clearing equipment</i>	NIL
2	<i>Clearance priorities</i>	NIL
3	<i>Remarks</i>	NIL

#### GVSN AD 2.8 APRONS, TAXIWAYS AND CHECK LOCATIONS / POSITIONS DATA

1	<i>Apron designation, surface and strength</i>	Designation: APRON Surface: Asphalt Strength: 20 TON SIWL
2	<i>Taxiway designation, width, surface and strength</i>	Designation: TWY Width: 15 M Surface: Asphalt Strength: 20 TON SIWL
3	<i>Altimeter checkpoint location and elevation</i>	NIL
4	<i>VOR checkpoints</i>	NIL
5	<i>INS checkpoints</i>	NIL
6	<i>Remarks</i>	NIL

#### GVSN AD 2.9 SURFACE MOVEMENT GUIDANCE AND CONTROL SYSTEM AND MARKINGS

1	<i>Use of aircraft stand ID signs, TWY guide lines and visual docking / parking guidance system at aircraft stands</i>	Taxiing guidance signs at all intersections with TWY and RWY at all holding positions. Guidelines at APRON
2	<i>RWY and TWY markings and lights</i>	RWY: Designation, THR, DTHR, TDZ and CL, marked TWY: CL, holding positions, marked

3	Stop bars and RWY guard lights	NIL
4	Other RWY protection measures	NIL
5	Remarks	NIL

#### GVSN AD 2.10 AERODROME OBSTACLES

<i>In Area 2</i>					
<i>OBST ID / Designation</i>	<i>OBST type</i>	<i>OBST position</i>	<i>ELEV / HGT</i>	<i>Markings / Type / Colour of lighting</i>	<i>Remarks</i>
<i>a</i>	<i>b</i>	<i>c</i>	<i>d</i>	<i>e</i>	<i>f</i>
NIL	NIL	NIL	NIL	NIL	NIL

<i>In Area 3</i>					
<i>OBST ID / Designation</i>	<i>OBST type</i>	<i>OBST position</i>	<i>ELEV / HGT</i>	<i>Markings / Type / Colour of lighting</i>	<i>Remarks</i>
<i>a</i>	<i>b</i>	<i>c</i>	<i>d</i>	<i>e</i>	<i>f</i>
NIL	NIL	NIL	NIL	NIL	NIL

To be developed.

#### GVSN AD 2.11 METEOROLOGICAL INFORMATION PROVIDED

1	Associated MET office	Aeronautical MET Station
2	Hours of service MET office outside hours	07:00 - 19:00 NIL
3	Office responsible for TAF preparation Periods of validity Interval of issuance	NIL NIL NIL
4	Availability of TREND forecast Interval of issuance	NIL NIL
5	Briefing / Consultation provided	NIL
6	Flight documentation Language(s) used	NIL English
7	Charts and other information displayed or available for briefing or consultation	NIL
8	Supplementary equipment available for providing information	AWOS: Surface wind for RWY 01, temperature, dew point, relative humidity and altimeter setting..
9	ATS units provided with information	PREGUICA INFO (AFIS); SAL APP and SAL ACC
10	Additional information (Limitation of service, etc.)	MET observer duty in own space

#### GVSN AD 2.12 RUNWAY PHYSICAL CHARACTERISTICS

<i>Designations RWY NR</i>	<i>True BRG</i>	<i>Dimensions of RWY(M)</i>	<i>Strength (PCN) &amp; surface of RWY and SWY</i>	<i>THR coordinates RWY end coordinates THR geoid undulation</i>	<i>THR elevation and highest elevation of TDZ of precision APP RWY</i>
1	2	3	4	5	6
01	357°	1398 X 23	20 TON SIWL Asphalt	163501.34N 0241701.74W 163540.66N 0241704.01W 29 M / 95 FT	179 M / 587 FT NIL

Designations RWY NR	True BRG	Dimensions of RWY(M)	Strength (PCN) & surface of RWY and SWY	THR coordinates RWY end coordinates THR geoid undulation	THR elevation and highest elevation of TDZ of precision APP RWY
1	2	3	4	5	6
19	177°	1398 X 23	20 TON SIWL Asphalt	163540.66N 0241704.01W 163459.89N 0241701.65W 29 M / 95 FT	181 M / 594 FT NIL

Slope of RWY-SWY	SWY dimensions (M)	CWY dimensions (M)	Strip dimensions (M)	RWY end safety area (M)	Location / description of arresting system	OFZ	Remarks
7	8	9	10	11	12	13	14
NIL	NIL	NIL	1375 X 150	90 X 60	NIL	NIL	NIL
NIL	NIL	NIL	1375 X 150	90 X 60	NIL	NIL	NIL

#### GVSN AD 2.13 DECLARED DISTANCES

RWY Designator	TORA (M)	TODA (M)	ASDA (M)	LDA (M)	Remarks
1	2	3	4	5	6
01	1398	1398	1398	1210	DTHR 188 M
19	1255	1255	1255	1255	NIL

#### GVSN AD 2.14 APPROACH AND RUNWAY LIGHTING

RWY Designator	APCH LGT type LEN INTST	THR LGT colour WBAR	VASIS (MEHT) PAPI	TDZ LGT LEN	RWY CL LGT LEN, spacing, colour, INTST	RWY edge LGT LEN, spacing, colour INTST	RWY end LGT colour WBAR	SWY LGT LEN colour	Remarks
1	2	3	4	5	6	7	8	9	10
01	NIL	NIL	NIL	NIL	NIL	NIL	NIL	NIL	NIL
19	NIL	NIL	NIL	NIL	NIL	NIL	NIL	NIL	NIL

#### GVSN AD 2.15 OTHER LIGHTING SECONDARY POWER SUPPLY

1	ABN / IBN location, characteristics and hours of operation	NIL
2	LDI / Anemometer location and LGT	NIL
3	TWY ledge and CL lighting	NIL
4	Secondary power supply / switch - over time	NIL
5	Remarks	NIL

#### GVSN AD 2.16 HELICOPTER LANDING AREA

1	Coordinates TLOF or THR of FATO Geoid undulation	NIL
2	TLOF and / or FATO elevation M / FT	NIL
3	TLOF and FATO area dimensions, surface, strength, marking	NIL
4	True BRG of FATO	NIL
5	Declared distance available	NIL
6	APP and FATO lighting	NIL

7	Remarks	Use the RWY
---	---------	-------------

**GVSN AD 2.17 ATS AIRSPACE**

1	Designation and lateral limits	Sao Nicolau ATZ Circle of 5 NM centred on 163521N 0241702W (Sao Nicolau Island / Pregoica ARP)
2	Vertical limits	GND / MSL - 2000 FT
3	Airspace classification	Class G
4	ATS unit call sign Language(s)	SANICOLAU INFORMATION (AFIS) English, Portuguese
5	Transition altitude	NIL
6	Hours of applicability	H24
7	Remarks	NIL

**GVSN AD 2.18 ATS COMMUNICATION FACILITIES**

Service designation	Call sign	Channel(s)	SATVOICE number(s)	Logon address	Hours of operation	Remarks
1	2	3	4	5	6	7
AFIS	SANICOLAU INFORMATION	118.700 MHZ	NIL	NIL	HJ	NIL

**GVSN AD 2.19 RADIO NAVIGATION AND LANDING AIDS**

Type of aid, MAG VAR Type of supported OPS (For VOR / ILS give declination)	ID	Frequency(ies) Channel number(s) service provider RPI	Hours of operation	Position of transmitting antenna coordinates	Elevation of the transmitting antenna of DME, GBAS reference point	Service volume radius from GBAS reference point	Remarks
1	2	3	4	5	6	7	8
L	NCL	357 KHZ	H 24	163345.8N 0241659.5W	NIL	NIL	NIL

**GVSN AD 2.20 LOCAL TRAFFIC REGULATIONS**

**1. Aerodrome regulations**

NIL

**6. Taxiing - Limitations**

NIL

**2. Taxiing to and from stands**

Arriving aircraft will be allocated a parking position by the marshaller and will always be guided by his assistance.

**7. School and training flights - Technical test flights - Use of runways**

NIL

**3. Parking area for small aircraft (general aviation)**

NIL

**8. Helicopter traffic - Limitations**

NIL

**4. Parking area for helicopters**

NIL

**9. Removal of disabled aircraft from runways**

NIL

**5. Apron - Taxiing during winter conditions**

NIL

**GVSN AD 2.21 NOISE ABATEMENT PROCEDURES**

NIL

**GVSN AD 2.22 FLIGHT PROCEDURES**

NIL

**GVSN AD 2.23 ADDITIONAL INFORMATION**

NIL

**GVSN AD 2.24 CHARTS RELATED TO AN AERODROME**

*Chart name*

*Page*

---

AERODROME CHART - ICAO

GVSN AD 2-7

VISUAL APPROACH CHART - ICAO

GVSN AD 2-8

**AERODROME  
CHART**

16°35'21"N  
024°17'02"W AD Elev.181m/594ft

AFIS 118.7

**PREGUIÇA  
AEROPORTO DA PREGUIÇA**

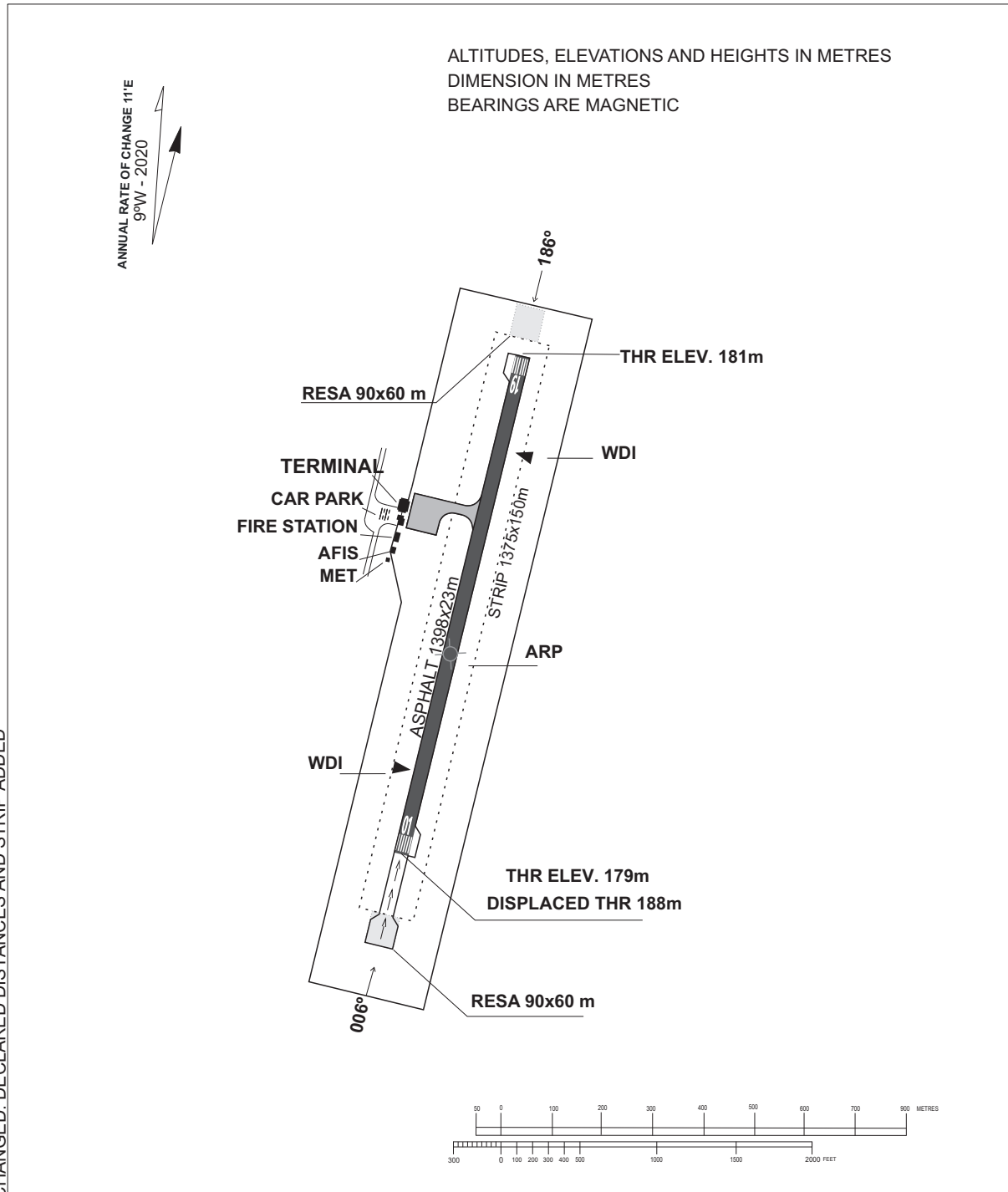

CHANGED: DECLARED DISTANCES AND STRIP ADDED

RWY	DIRECTION	THR	BEARING	STRENGTH	DECLARED DISTANCES				
					RWY	TORA	TODA	ASDA	LDA
01	006°	16°35'01"N 024°17'01"W		20 TON SIWL					
19	186°	16°35'40"N 024°17'04"W		20 TON SIWL	01	1398	1398	1398	1210
					19	1255	1255	1255	1255
HELIPORT					OTHER:				

**VISUAL APPROACH  
CHART**

16°35'21"N  
024°17'02"W AD Elev.181m/594ft

AFIS 118.7

**PREGUIÇA  
AEROPORTO DA PREGUIÇA**

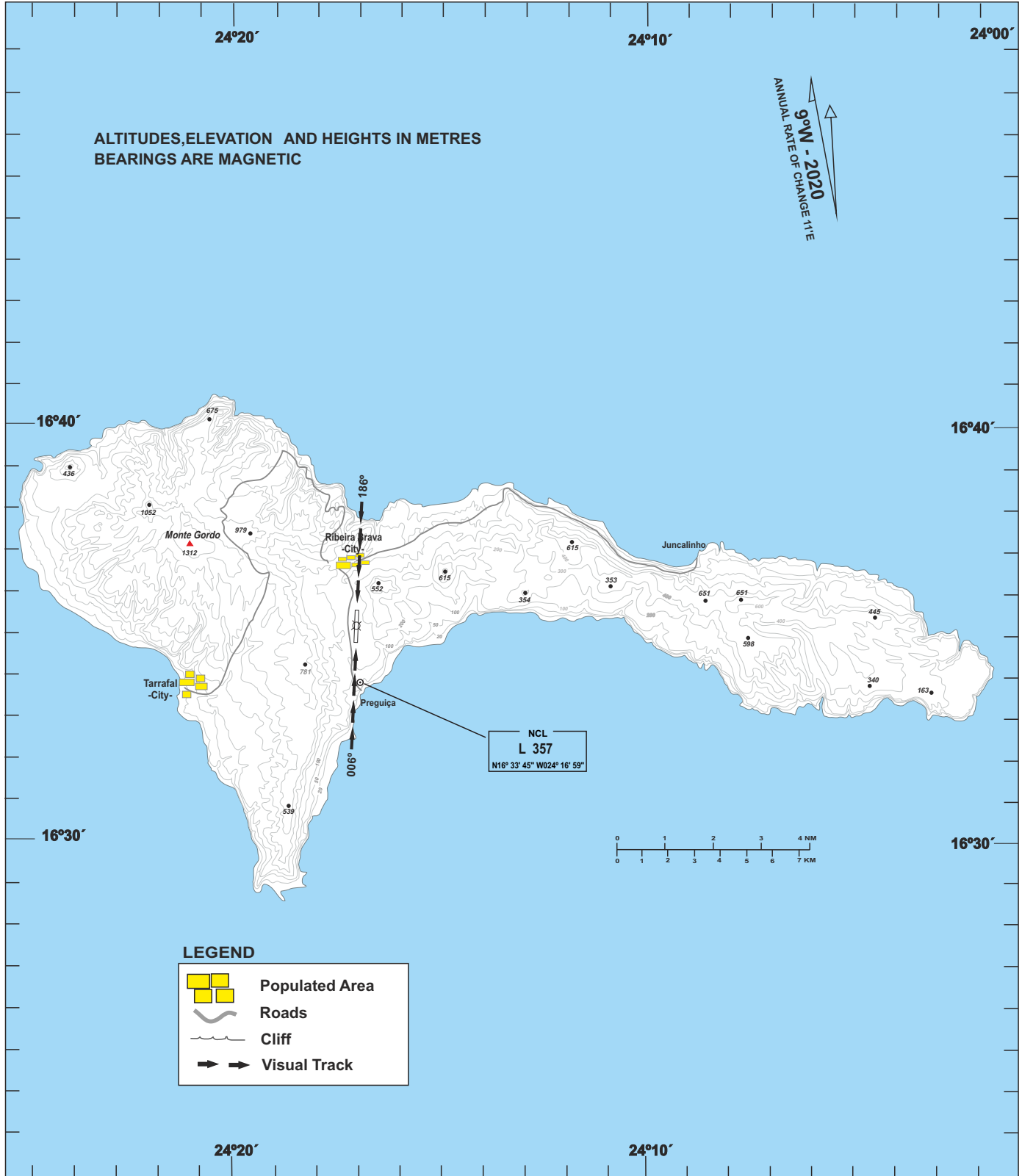



**GVSV AD 2.1 AERODROME LOCATION INDICATOR AND NAME**

GVSV - SAO PEDRO / CESARIA EVORA

**GVSV AD 2.2 AERODROME GEOGRAPHICAL AND ADMINISTRATIVE DATA**

1	ARP coordinates and site at AD	165001N 0250316W Midpoint between RWY 06 / 24
2	Direction and distance from city	12 KM SW of Mindelo
3	Elevation / Reference temperature / Mean low temperature	31 M (110 FT) / 30° C / NIL
4	Geoid Undulation at AD ELEV PSN	30 M (97 FT)
5	MAG VAR / Date of information / Annual change	10°W (2019) / 0.17° decreasing
6	AD operator, address, telephone, telefax, e-mail, AFS, website	ASA - Empresa Nacional de Aeroportos e Seguranca Aerea - S.A. Aeroporto Cesaria Evora P.O. Box 523 Sao Pedro Sao Vicente Island Republic of Cabo Verde TEL: +238 2323715 +238 2300602 Telefax:+238 2327553 e-mail: NIL AFS: GVSVDYX Http: NIL
7	Types of traffic permitted (IFR/VFR)	IFR / VFR
8	Remarks	NIL

**GVSV AD 2.3 OPERATIONAL HOURS**

1	AD operator	07:00 - 23:00
2	Customs and immigration	07:00 - 23:00
3	Health and sanitation	07:00 - 23:00
4	AIS Briefing office	07:00 - 23:00
5	ATS Reporting office (ARO)	07:00 - 23:00
6	MET Briefing office	H 24
7	ATS	07:00 - 23:00
8	Fuelling	MON - FRI 08:30 - 16:30 Refuelling outside these schedules only with prior coordination (1 HR in advance) through the contacts:  TEL: +238 9854115 e-mail: rafael.lima@vivoenergy.com
9	Handling	07:00 - 23:00
10	Security	07:00 - 23:00
11	De-icing	NIL
12	Remarks	Prior coordination (3 HR in advance) through the AD administration is required for non scheduled flights. Outside HR available on request (24 HR in advance).

**GVSV AD 2.4 HANDLING SERVICES AND FACILITIES**

1	<i>Cargo handling facilities</i>	Automatic and manual passenger ladder, ambulift 1500 KG, loads 2500 KG, treadmill loader 3500 KG, dump truck water carts, GPU air starter 277 PPM, transloader 3630 KG, bus 96 PX and wheelchair and tow tractors 3000 KG
2	<i>Fuel / oil types</i>	Jet A1 / NIL
3	<i>Fuelling facilities / capacity</i>	Refuelling tank truck with capacity of 18000 L (1025 L per minute). Total desposit capacity of 74000 L.
4	<i>De-icing facilities</i>	NIL
5	<i>Hangar space for visiting aircraft</i>	NIL
6	<i>Repair facilities for visiting aircraft</i>	NIL
7	<i>Remarks</i>	NIL

**GVSV AD 2.5 PASSENGER FACILITIES**

1	<i>Hotel(s)</i>	Near AD and in the city
2	<i>Restaurant(s)</i>	Near AD and in the city
3	<i>Transportation</i>	Taxis
4	<i>Medical facilities</i>	In the city
5	<i>Bank and Post office</i>	In the city
6	<i>Tourist office</i>	In the city
7	<i>Remarks</i>	NIL

**GVSV AD 2.6 RESCUE AND FIRE FIGHTING SERVICES**

1	<i>AD category for fire fighting</i>	CAT 7
2	<i>Rescue equipment</i>	NIL
3	<i>Capability for removal of disabled aircraft</i>	All operators are required to put in place appropriate agreements for the supply of equipment for the removal of disabled aircraft at the airport movement area or at its proximity and to ensure its use when required. Operators are also required to submit such agreements for airport administration appraisal and recording.
4	<i>Remarks</i>	Any change in aircraft type (scheduled or non - scheduled flights) implying a change in the ARFF category only with prior coordination through the AD administration (3HR in advance).

**GVSV AD 2.7 SEASONAL AVAILABILITY - CLEARING**

1	<i>Type(s) of clearing equipment</i>	NIL
2	<i>Clearance priorities</i>	NIL
3	<i>Remarks</i>	NIL

**GVSV AD 2.8 APRONS, TAXIWAYS AND CHECK LOCATIONS / POSITIONS DATA**

1	<i>Apron designation, surface and strength</i>	Designation: APRON 1 Surface: Asphalt Strength: PCN 42 / F / B / X / T Designation: APRON 2 Surface: Asphalt Strength: PCN 39 / F / B / Y / T Designation: APRON 3 Surface: Asphalt Strength: PCN 26 / F / B / Y / T
2	<i>Taxiway designation, width, surface and strength</i>	Designation: TWY A Width: 18 M Surface: Asphalt Strength: PCN 41 / F / B / Y / T Designation: TWY B Width: 26 M Surface: Asphalt Strength: PCN 26 / F / B / Y / T Designation: TWY C Width: 18 M Surface: Asphalt Strength: PCN 26 / F / B / Y / T
3	<i>Altimeter checkpoint location and elevation</i>	TWY A - holding point: 24 M (80 FT) TWY B - holding point: 22 M (71 FT) TWY C - holding point: 8 M (27 FT)
4	<i>VOR checkpoints</i>	NIL
5	<i>INS checkpoints</i>	NIL
6	<i>Remarks</i>	NIL

**GVSV AD 2.9 SURFACE MOVEMENT GUIDANCE AND CONTROL SYSTEM AND MARKINGS**

1	<i>Use of aircraft stand ID signs, TWY guide lines and visual docking / parking guidance system at aircraft stands</i>	TWY: Guide lines at APRON, taxiing guidance exiting RWYs. APRON: Guide lines at APRON, ID stand 1 and 2.
2	<i>RWY and TWY markings and lights</i>	RWY: Designation, TDZ, aiming point, CL, turnpad marked. THR, DTHR, edge, runway end marked and lighted. TWY: CL, holding position TWY A and C, edge marked and lighted.
3	<i>Stop bars and RWY guard lights</i>	NIL
4	<i>Other RWY protection measures</i>	NIL
5	<i>Remarks</i>	NIL

**GVSV AD 2.10 AERODROME OBSTACLES**

<i>In Area 2</i>					
<i>OBST ID / Designation</i>	<i>OBST type</i>	<i>OBST position</i>	<i>ELEV / HGT</i>	<i>Markings / Type / Colour of lighting</i>	<i>Remarks</i>
<i>a</i>	<i>b</i>	<i>c</i>	<i>d</i>	<i>e</i>	<i>f</i>
NIL	NIL	NIL	NIL	NIL	NIL

<i>In Area 3</i>					
<i>OBST ID / Designation</i>	<i>OBST type</i>	<i>OBST position</i>	<i>ELEV / HGT</i>	<i>Markings / Type / Colour of lighting</i>	<i>Remarks</i>
<i>a</i>	<i>b</i>	<i>c</i>	<i>d</i>	<i>e</i>	<i>f</i>
NIL	NIL	NIL	NIL	NIL	NIL

To be developed.

**GVSV AD 2.11 METEOROLOGICAL INFORMATION PROVIDED**

1	Associated MET office	Aeronautical MET Station
2	Hours of service MET office outside hours	H 24 NIL
3	Office responsible for TAF preparation Periods of validity Interval of issuance	Analysis and weather forecast centre GVACYMYX 24 HR NIL
4	Availability of TREND forecast Interval of issuance	TREND NIL
5	Briefing / Consultation provided	NIL
6	Flight documentation Language(s) used	NIL
7	Charts and other information displayed or available for briefing or consultation	NIL
8	Supplementary equipment available for providing information	AWOS - Automated Weather Observation Service
9	ATS units provided with information	SAN VICENTE TWR, SAL APP, SAL ACC
10	Additional information (Limitation of service, etc.)	Aviation meteorological parameters permanently broadcast on 127.500 MHZ.

**GVSV AD 2.12 RUNWAY PHYSICAL CHARACTERISTICS**

Designations RWY NR	True BRG	Dimensions of RWY(M)	Strength (PCN) & surface of RWY and SWY	THR coordinates RWY end coordinates THR geoid undulation	THR elevation and highest elevation of TDZ of precision APP RWY
1	2	3	4	5	6
06	053.61°	2000 X 45	PCN 42 / F / B / X / T	164944.97N 0250339.68W 165020.66N 0250249.38W 97 FT (30 M)	8 M (28 FT) / NIL
24	233.62°	2000 X 45	PCN 42 / F / B / X / T	165020.66N 0250249.38W 164942.07N 0250343.76W 97 FT (30 M)	31 M (101 FT) / NIL

Slope of RWY-SWY	SWY dimensions (M)	CWY dimensions (M)	Strip dimensions (M)	RWY end safety area (M)	Location / description of arresting system	OFZ	Remarks
7	8	9	10	11	12	13	14
0.908 %	NIL	100 X 150	2120 X 150	90 X 90	NIL	NIL	NIL
0.908 %	NIL	150 X 150	2120 X 150	180 X 90	NIL	NIL	NIL

**GVSV AD 2.13 DECLARED DISTANCES**

RWY Designator	TORA (M)	TODA (M)	ASDA (M)	LDA (M)	Remarks
1	2	3	4	5	6
06	2000	2100	2000	1850	DTHR 150 M
24	2000	2150	2000	2000	NIL

**GVSV AD 2.14 APPROACH AND RUNWAY LIGHTING**

<i>RWY Designator</i>	<i>APCH LGT type LEN INTST</i>	<i>THR LGT colour WBAR</i>	<i>VASIS (MEHT) PAPI</i>	<i>TDZ LGT LEN</i>	<i>RWY CL LGT LEN, spacing, colour, INTST</i>	<i>RWY edge LGT LEN, spacing, colour INTST</i>	<i>RWY end LGT colour WBAR</i>	<i>SWY LGT LEN colour</i>	<i>Remarks</i>
1	2	3	4	5	6	7	8	9	10
06	NIL	green	PAPI Left 3° (54 FT / 16 M)	NIL	NIL	white, 60 M	red	NIL	NIL
24	NIL	green	NIL	NIL	NIL	white, 60 M	red	NIL	NIL

**GVSV AD 2.15 OTHER LIGHTING SECONDARY POWER SUPPLY**

1	<i>ABN / IBN location, characteristics and hours of operation</i>	ABN at tower building, ALT FLG G / W every 5 SEC, HO - IMC W 7850 CD G 7850 CD
2	<i>LDI / Anemometer / WDI location and LGT</i>	LDI: NIL Anemometer: NIL WDI: Left side of RWY 06 and right side of RWY 24 / NIL
3	<i>TWY ledge and CL lighting</i>	TWY A: edge TWY B: edge TWY C: edge
4	<i>Secondary power supply / switch - over time</i>	Secondary power supply to all lighting at AD / 7 SEC
5	<i>Remarks</i>	NIL

**GVSV AD 2.16 HELICOPTER LANDING AREA**

1	<i>Coordinates TLOF or THR of FATO Geoid undulation</i>	NIL
2	<i>TLOF and / or FATO elevation M / FT</i>	NIL
3	<i>TLOF and FATO area dimensions, surface, strength, marking</i>	NIL
4	<i>True BRG of FATO</i>	NIL
5	<i>Declared distance available</i>	NIL
6	<i>APP and FATO lighting</i>	NIL
7	<i>Remarks</i>	NIL

**GVSV AD 2.17 ATS AIRSPACE**

1	<i>Designation and lateral limits</i>	SAO VICENTE CTR Circle 25 NM centred on 165001N 0250316W (Sao Pedro / Cesaria Evora ARP)
2	<i>Vertical limits</i>	GND / MSL - FL 105
3	<i>Airspace classification</i>	Class C
4	<i>ATS unit call sign Language(s)</i>	SAN VICENTE TWR English, Portuguese
5	<i>Transition altitude</i>	7000 FT
6	<i>Hours of applicability</i>	07:00 - 23:00
7	<i>Remarks</i>	No night circuits are permitted

**GVSV AD 2.18 ATS COMMUNICATION FACILITIES**

<i>Service designation</i>	<i>Call sign</i>	<i>Channel(s)</i>	<i>SATVOICE number(s)</i>	<i>Logon address</i>	<i>Hours of operation</i>	<i>Remarks</i>
1	2	3	4	5	6	7
APP / TWR	SAN VICENTE TWR	118.400 MHZ 121.500 MHZ	NIL	NIL	HO HO	NIL Emergency

**GVSV AD 2.19 RADIO NAVIGATION AND LANDING AIDS**

<i>Type of aid, MAG VAR Type of supported OPS (For VOR / ILS give declination)</i>	<i>ID</i>	<i>Frequency(ies) Channel number(s) service provider RPI</i>	<i>Hours of operation</i>	<i>Position of transmitting antenna coordinates</i>	<i>Elevation of the transmitting antenna of DME, GBAS reference point</i>	<i>Service volume radius from GBAS reference point</i>	<i>Remarks</i>
1	2	3	4	5	6	7	8
NDB 11°W	SVT	333 KHZ	H 24	164944.9N 0250352.6W	NIL	NIL	NIL
ILS LLZ 11°W	SP	109.700 MHZ	H 24	165028.5N 0250238.3W	NIL	NIL	NIL

### GVSV AD 2.20 LOCAL TRAFFIC REGULATIONS

**1. Aerodrome regulations**

NIL

**2. Taxiing to and from stands**

Arriving aircraft will be allocated a parking position by the marshaller and will always be guided by his assistance.

**3. Parking area for small aircraft (general aviation)**

NIL

**4. Parking area for helicopters**

NIL

**5. Apron - Taxiing during winter conditions**

NIL

**6. Taxiing - Limitations**

- a) All aircraft with ACN greater than 25 shall use TWY A and APRON 1 for taxiing and parking respectively.
- b) 180° turns on the RWY are forbidden for aircraft MTOW above 30 TONS. These operations must be done only on the turning bay of each RWY.

**7. School and training flights - Technical test flights - Use of runways**

NIL

**8. Helicopter traffic - Limitations**

NIL

**9. Removal of disabled aircraft from runways**

NIL

### GVSV AD 2.21 NOISE ABATEMENT PROCEDURES

NIL

### GVSV AD 2.22 FLIGHT PROCEDURES

**1. General**

**1.1 Minimum Sector Altitude (MSA)**

Within a circle of 25 NM centred on NDB SVT, 8500 FT north of QDM 100° and QDM 230°, 4600 FT for the south side.

**1.2 Night operations**

Prohibited at the airport by aircraft of code 4 aircraft and all turbo jet aircraft.

**1.3 RNAV GNSS SIDs and STARs**

Operational under radar environment, according ICAO Doc 9613 item 3.1.2.3.

**2. Procedures for IFR flights within aerodrome CTR**

All IFR departures RWY 06 are required to maintain VMC to 1500 FT minimum.

**3. Radar procedures within aerodrome CTR**

NIL

### GVSV AD 2.23 ADDITIONAL INFORMATION

Due to the characteristics of surrounding terrain and obstacles, Sao Pedro / Cesaria Evora is designated as a special aerodrome in accordance with cv car 8.j.1160.

**GVSV AD 2.24 CHARTS RELATED TO AN AERODROME**

<i>Chart name</i>	<i>Page</i>
AERODROME CHART	GVSV AD 2-9
AERODROME OBSTACLE CHART RWY 06 TYPE A - 1	GVSV AD 2-10
AERODROME OBSTACLE CHART RWY 06 TYPE A - 2	GVSV AD 2-11
AERODROME OBSTACLE CHART RWY 24 TYPE A	GVSV AD 2-12
STANDARD DEPARTURE CHART - INSTRUMENT (SID) RWY 06	GVSV AD 2-13
STANDARD DEPARTURE CHART - INSTRUMENT (SID) RNAV (GNSS) RWY 06 - ICAO	GVSV AD 2-14
STANDARD DEPARTURE CHART - INSTRUMENT (SID) RNAV (GNSS) RWY 06 (VERSO) - ICAO	GVSV AD 2-15
STANDARD DEPARTURE CHART - INSTRUMENT (SID) RWY 24	GVSV AD 2-16
STANDARD DEPARTURE CHART - INSTRUMENT (SID) RNAV (GNSS) RWY 24 - ICAO	GVSV AD 2-17
STANDARD DEPARTURE CHART - INSTRUMENT (SID) RNAV (GNSS) RWY 24 (VERSO) - ICAO	GVSV AD 2-18
STANDARD ARRIVAL CHART - INSTRUMENT (STAR) RNAV (GNSS) RWY 06 - ICAO	GVSV AD 2-19
STANDARD ARRIVAL CHART - INSTRUMENT (STAR) RNAV (GNSS) RWY 06 (VERSO) - ICAO	GVSV AD 2-20
STANDARD ARRIVAL CHART - INSTRUMENT (STAR) RNAV (GNSS) RWY 24 - ICAO	GVSV AD 2-21
STANDARD ARRIVAL CHART - INSTRUMENT (STAR) RNAV (GNSS) RWY 24 (VERSO) - ICAO	GVSV AD 2-22
STANDARD ARRIVAL CHART - INSTRUMENT (STAR) RWY 06 / 24	GVSV AD 2-23
INSTRUMENT APPROACH CHART RNAV (GNSS) RWY 06 - ICAO	GVSV AD 2-24
INSTRUMENT APPROACH CHART RNAV (GNSS) RWY 06 (VERSO) - ICAO	GVSV AD 2-25
INSTRUMENT APPROACH CHART RNAV (GNSS) RWY 24 - ICAO	GVSV AD 2-26
INSTRUMENT APPROACH CHART RNAV (GNSS) RWY 24 (VERSO) - ICAO	GVSV AD 2-27
INSTRUMENT APPROACH CHART NDB RWY 06 CAT A - C - ICAO	GVSV AD 2-28
INSTRUMENT APPROACH CHART NDB / LOC RWY 06 CAT A - C - ICAO	GVSV AD 2-29
VISUAL APPROACH CHART	GVSV AD 2-30



**AERODROME CHART**    16°50'01N    ELEV 101ft    TWR 118.4    **SAO PEDRO**  
025°03'16"    **AEROPORTO INTL CESARIA EVORA**

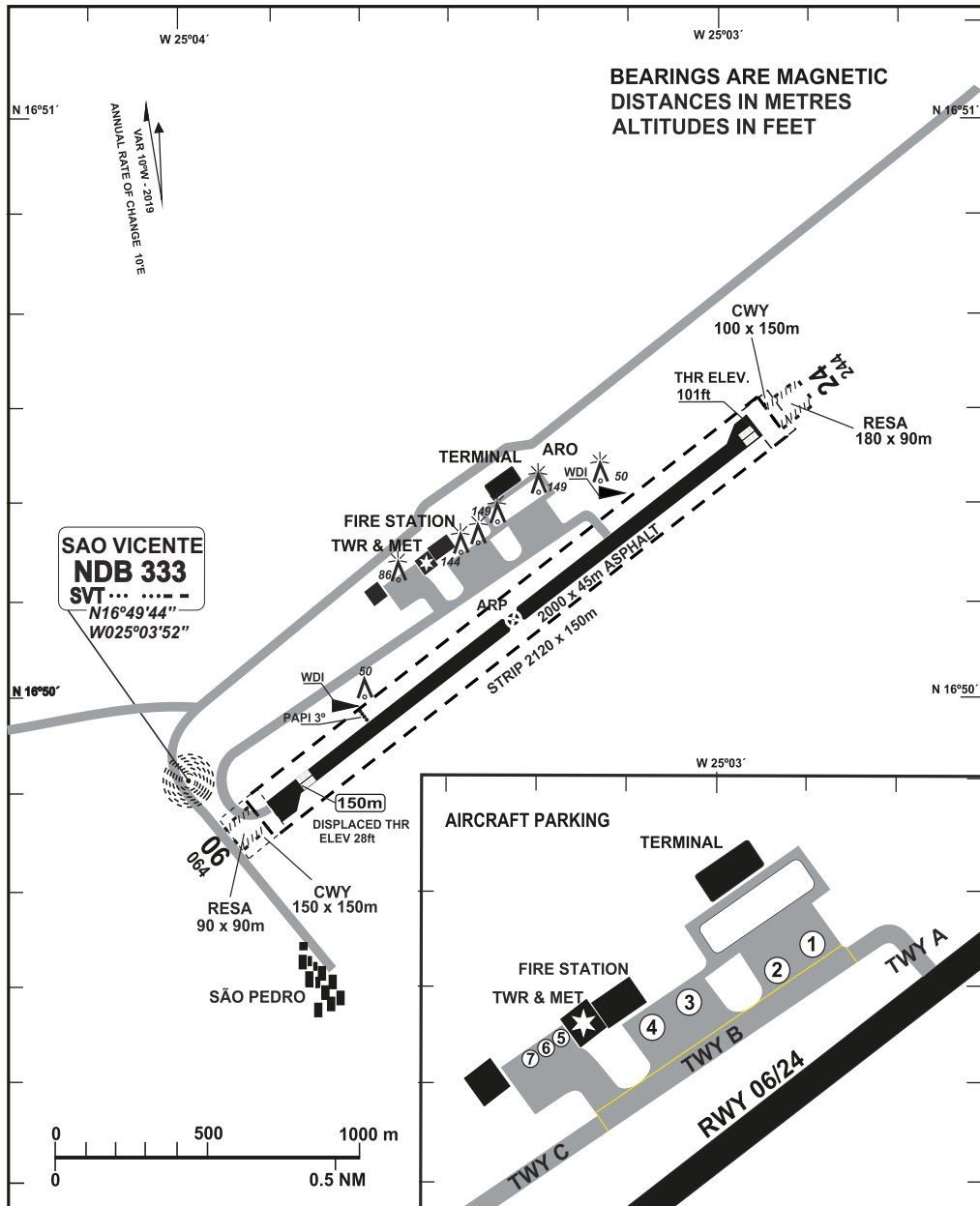

RWY	DIRECTION	THR	BEARING	STRENGTH	LIGHTING				
06	064°	16°49'44.97"N 025°03'39.68"W	PCN 42F/B/X/T		RWY	PAPI	APPROACH	THRESHOLD	RUNWAY
24	244°	16°50'20.66"N 025°02'49.38"W	PCN 42F/B/X/T		06	3°	N/A	RED	RTILS
<b>HELIPORT</b>					OTHER: Taxiways				

# AERODROME OBSTACLE CHART TYPE A (OPERATING LIMITATIONS)

## AEROPORTO INTL CESARIA EVORA - SAO PEDRO

### RWY 06

SHEET 1

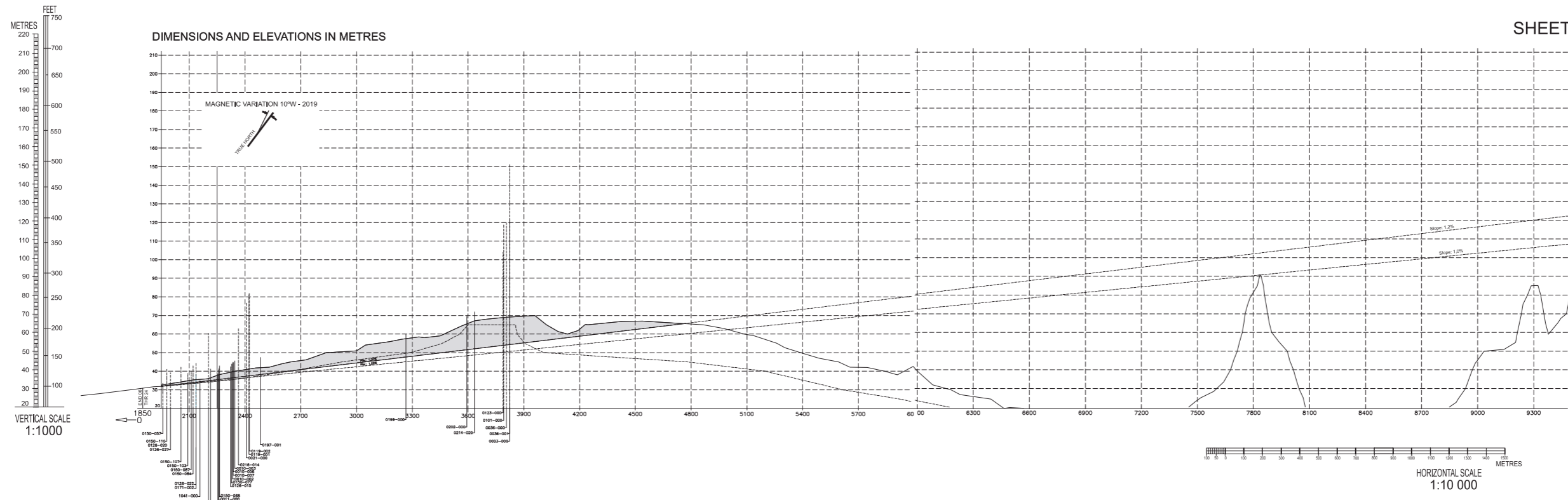

- (1) Obstacle heights are based on survey data of 2015.
- (2) Accuracy within ICAO specifications.
- (3) Take-off RWY 06 origin of the 1.2% surface is end of clearway.

LEGEND		SCALES
--- Runway centre line extended in both direction	● Tree, Bush	H = 1:10.000
--- Obstacle inside surface	⊠ Electrical Tower, Metallic	V = 1:1000
--- Obstacle inside surface	⊠ Antenna	
--- Terrain profile by axis	⊠ Antenna over building	
--- Terrain profile by obstacles	⊠ Pole, Mast	
■ Terrain that exceeds the 1,2% slope	⊠ Electric Pole	
	⊠ Seal	
	⊠ Building	
	⊠ Terrain	
	⊠ Road	
	⊠ Others Obstacles	
	▲ GEODETIC NETWORK, THR, ARP, ETC.	
	⊠ WDI	
	⊠ RVR	
	⊠ APPROACH Light	
	⊠ PAPI	
	⊠ ILS LOCALIZER	
	⊠ Glide Slope	
	⊠ Lighting Tower	
	⊠ Depoist/Tank	
	⊠ NDB	
	⊠ Wind Turbine	

DECLARED DISTANCES	
RWY 06	TAKE-OFF RUN AVAILABLE (TORA)
2000	TAKE-OFF DISTANCE AVAILABLE (TODA)
2100	ACCELERATE STOP DISTANCE AVAILABLE (ASDA)
2000	LANDING DISTANCE AVAILABLE (LDA)
1850	

AMENDMENT RECORD	
No.	
Date	
Endorsed by	

# AERODROME OBSTACLE CHART TYPE A (OPERATING LIMITATIONS)

## AEROPORTO INTL CESARIA EVORA - SAO PEDRO

### RWY 06

SHEET 2

DIMENSIONS AND ELEVATIONS IN METRES

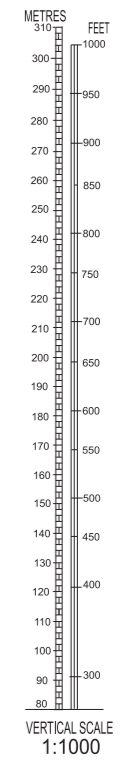
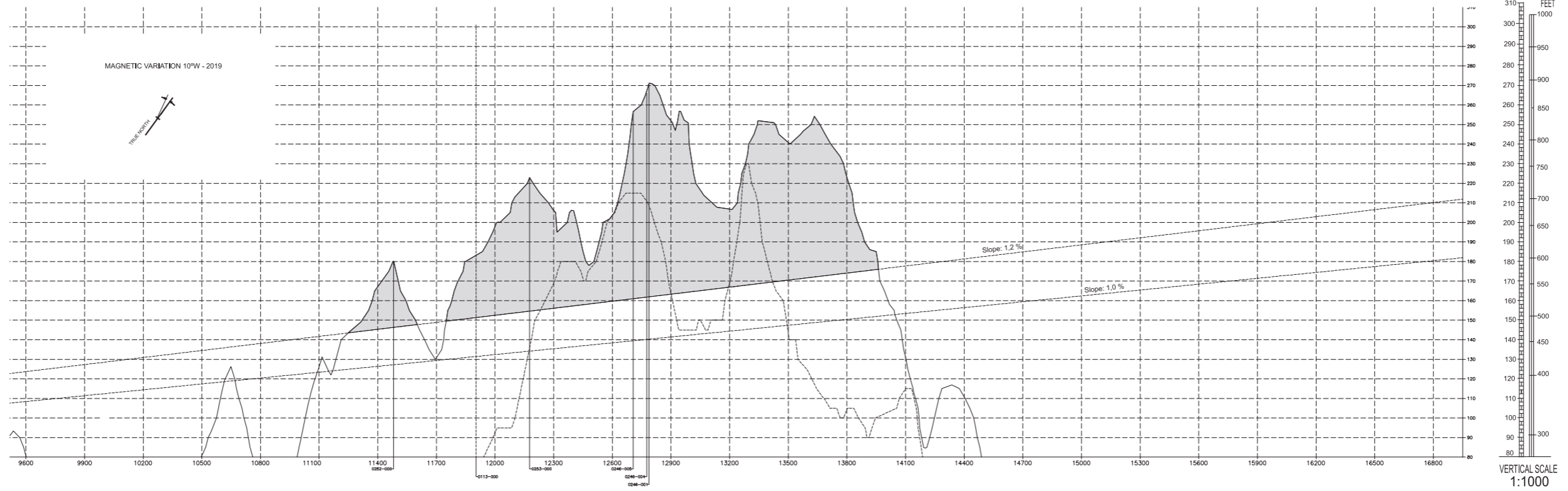

REFER SHEET 1



- (1) Obstacle heights are based on survey data of 2015.
- (2) Accuracy within ICAO specifications.
- (3) Take-off RWY 06 origin of the 1.2% surface is end of clearway.

LEGEND		SCALES	
--- Runway centre line extended in both direction	● Tree, Bush	H = 1:10,000	
- - - Obstacle inside surface	⊠ Electrical Tower, Metallic	V = 1:1000	
0216-000 Obstacle inside surface	⊠ Antenna		
--- Terrain profile by axis	⊠ Antenna over building		
--- Terrain profile by obstacles	⊠ Pole, Mast		
▨ Terrain that exceeds the 1,2% slope	⊠ Electric Pole		
	⊠ Seal		
	⊠ Building		
	⊠ Terrain		
	⊠ Road		
	⊠ Others Obstacles		
	⊠ GEODETIC NETWORK, THR, ARP, ETC.		
	⊠ WDI		
	⊠ RVR		
	⊠ APPROACH Light		
	⊠ PAPI		
	⊠ ILS LOCALIZER		
	⊠ Glide Slope		
	⊠ Lighting Tower		
	⊠ Deposit/Tank		
	⊠ NDB		
	⊠ Wind Turbine		

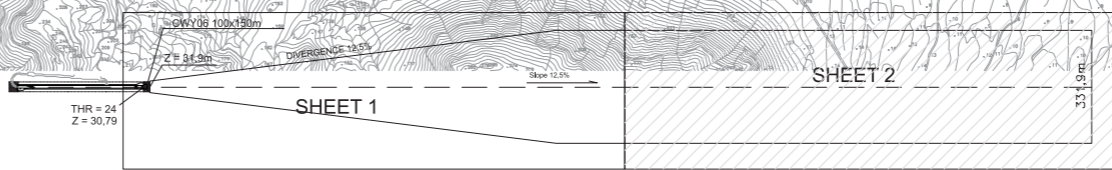

AMENDMENT RECORD	
No.	
Date	
Endorsed by	

**AERODROME OBSTACLE CHART  
TYPE A (OPERATING LIMITATIONS)**

**AEROPORTO INTL CESARIA EVORA - SAO PEDRO**

**RWY 24**

DIMENSIONS AND ELEVATIONS IN METRES

MAGNETIC VARIATION 10°W - 2019

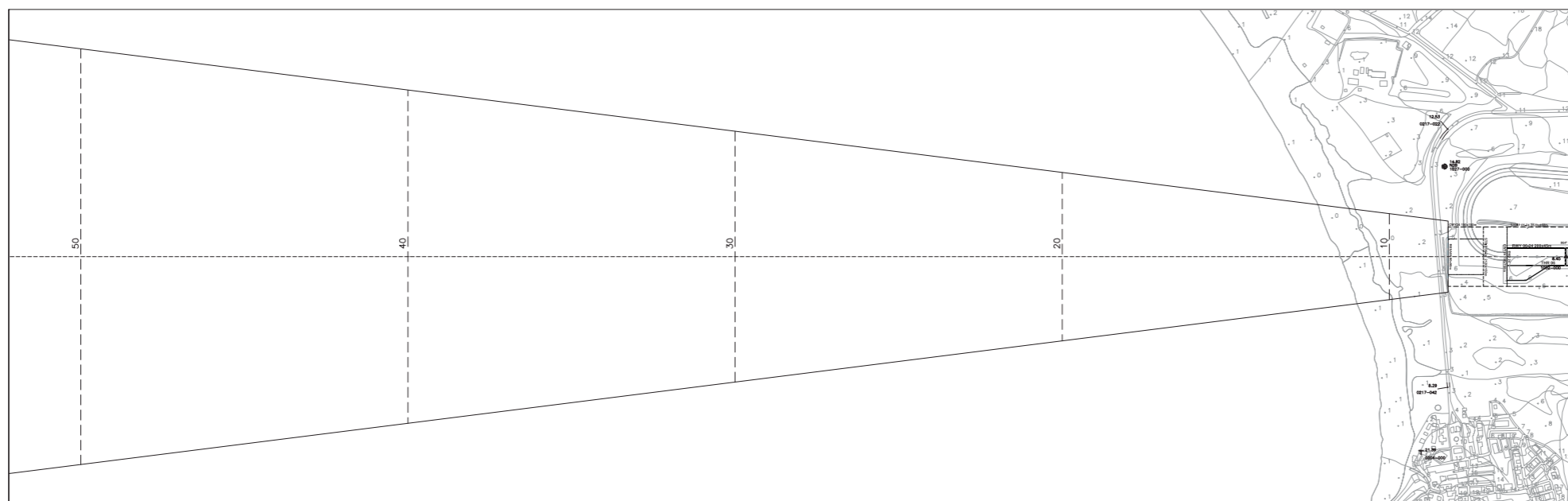
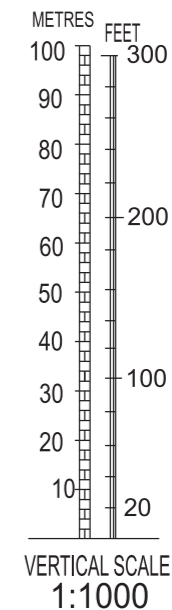
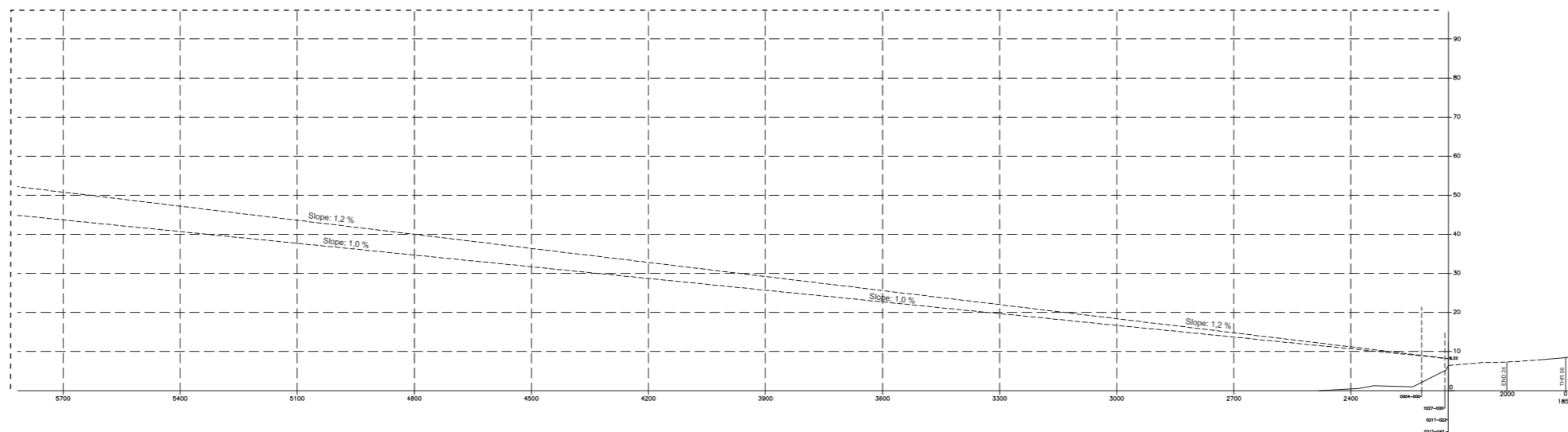

- (1) Obstacle heights are based on survey data of 2015.
- (2) Accuracy within ICAO specifications.
- (3) Take-off RWY 24 origin of the 1.2% surface is end of clearway.

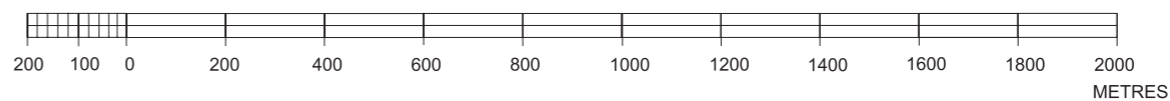

HORIZONTAL SCALE  
**1:10 000**

LEGEND		SCALES
--- Runway centre line extended in both direction	● Tree, Bush	H = 1:10 000
--- Obstacle inside surface	⊠ Electrical Tower, Metallic	V = 1:1000
0216-000 Obstacle inside surface	⊠ Antenna	
0216-000 Obstacle inside surface	⊠ Antenna over building	
--- Terrain profile by axis	⊠ Pole, Mast	
--- Terrain profile by obstacles	⊠ Electric Pole	
■ Terrain that exceeds the 1,2% slope	⊠ Seal	
	■ Building	
	⊠ Terrain	
	⊠ Road	
	⊠ Others Obstacles	
	▲ GEODETIC NETWORK, THR, ARP, ETC.	
	⊠ WDI	
	⊠ RVR	
	⊠ APPORACH Light	
	⊠ PAPI	
	⊠ ILS LOCALIZER	
	⊠ Glide Slope	
	⊠ Lighting Tower	
	⊠ Deposit/Tank	
	⊠ NDB	
	⊠ Wind Turbine	

DECLARED DISTANCES	
RWY 24	
2000	TAKE-OFF RUN AVAILABLE (TORA)
2150	TAKE-OFF DISTANCE AVAILABLE (TODA)
2000	ACCELERATE STOP DISTANCE AVAILABLE (ASDA)
2000	LANDING DISTANCE AVAILABLE (LDA)

AMENDMENT RECORD	
No.	
Date	
Endorsed by	

**STANDARD DEPARTURE CHART  
INSTRUMENT (SID)  
Categories A-B-C**

TWR 118.4  
APP  
ACC

**SÃO PEDRO CESARIA EVORA/Intl - (GVSV)**

**RWY 06**

MOPAC 2G, NEMDO 2G, NINAU 2G, SNT 2G, EDIPA 2G, EVKAS 2G

TRANSITIONAL ALTITUDE: 7 000

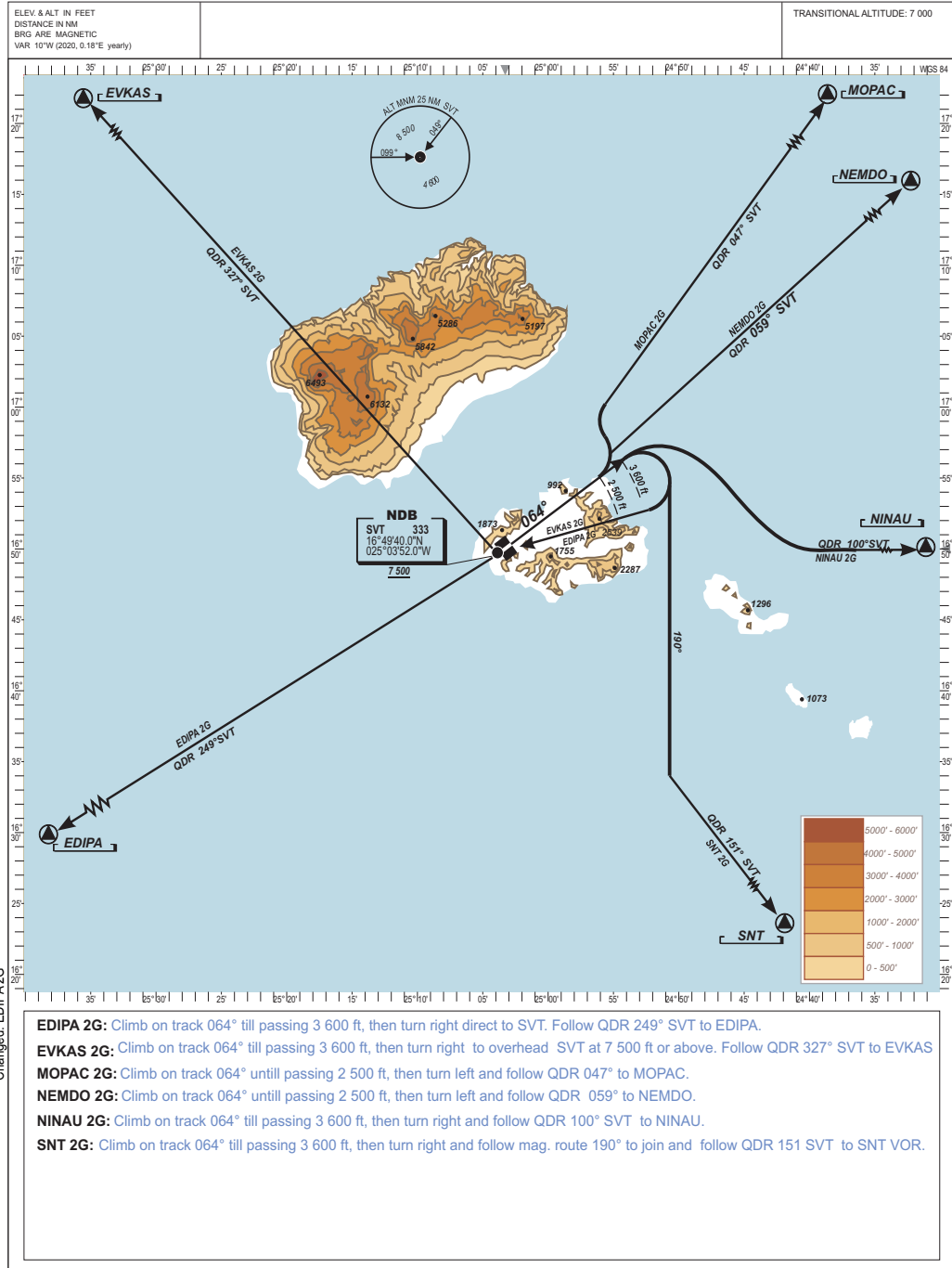

STANDARD INSTRUMENT  
RNAV(GNSS)  
DEPARTURE CHART  
(SID)- ICAO

AD ELEV 101 FT

VAR 10° W  
TA 7000

TWR 118.400

SÃO PEDRO / Cesária Évora Intl  
SAO VICENTE  
RWY 06

DENER1U, EDIPA1U, EVKAS1U, KESIK1U, LININ1U, MOPAC1U, NEMDO1U, NINAU1U, SISAU1U

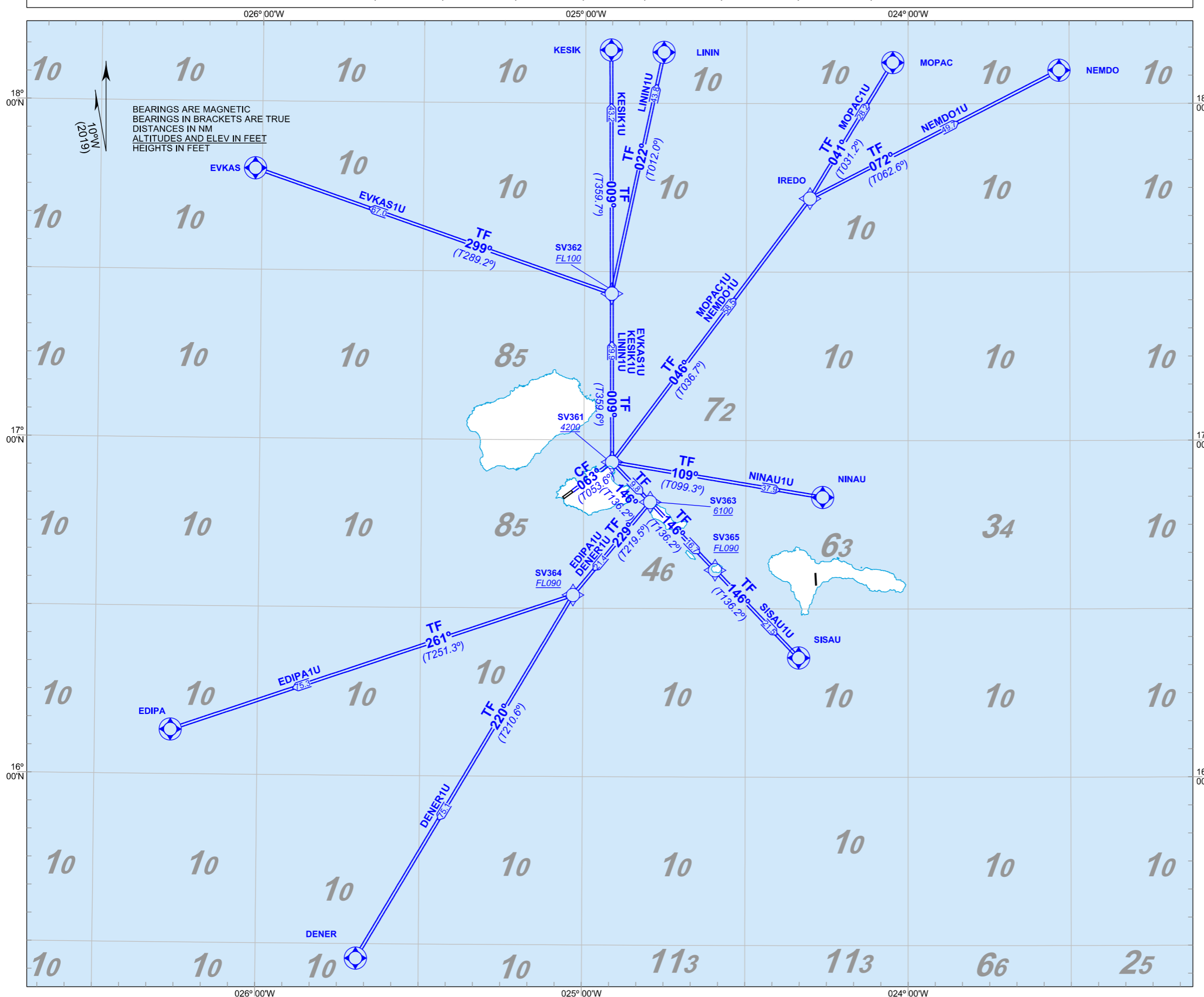

WAYPOINTS:

DENER:	15°27'24.0000"N	025°41'32.0000"W
EDIPA:	16°07'55.0000"N	026°16'00.0000"W
EVKAS:	17°48'03.0000"N	026°01'16.0000"W
IREDO:	17°43'06.0000"N	024°18'12.0000"W
KESIK:	18°09'28.0000"N	024°55'13.0000"W
LININ:	18°09'05.0000"N	024°45'24.0000"W
MOPAC:	18°07'20.0000"N	024°02'50.0000"W
NEMDO:	18°05'57.0000"N	023°31'54.0000"W
NINAU:	16°49'52.0000"N	024°15'47.0000"W
SISAU:	16°21'16.0000"N	024°20'11.0000"W
SV361:	16°56'03.6115"N	024°54'45.5715"W
SV362:	17°26'04.1420"N	024°54'57.1505"W
SV363:	16°48'57.9255"N	024°47'41.1815"W
SV364:	16°32'21.1650"N	025°01'53.1955"W
SV365:	16°36'52.1870"N	024°35'39.2805"W

RNP1 APPROVAL REQUIRED.  
IAS MAX 250 kt to reach FL100 or below

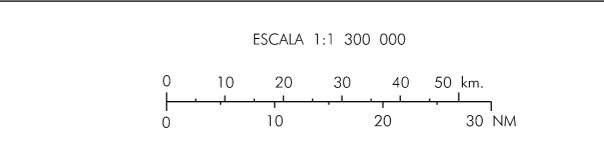

TEXTUAL DESCRIPTION	ABBREVIATED DESCRIPTION	Expected Path Terminator Coding	Fly-Over Required
NOTES APPLICABLE TO ALL SID: - RNP1 APPROVAL REQUIRED - REQUIRED GNSS - IAS MAX 250 Kt TO REACH FL100			
<b>SID DENER 1U RNAV (GNSS)</b>			
To SV361 on course 063PM at or above 4200 ft, turn right. To SV363 at or above 6100 ft, turn right. To SV364 at or above FL090, turn left. To <u>DENER</u> .	SV361(M063.A4200+R) - SV363(A6100+R) - SV364(F090+L) - <u>DENER</u>	CF TF TF TF	- - - Y
<b>SID EDIPA 1U RNAV (GNSS)</b>			
To SV361 on course 063PM at or above 4200 ft, turn right. To SV363 at or above 6100 ft, turn right. To SV364 at or above FL090, turn right. To <u>EDIPA</u> .	SV361(M063.A4200+R) - SV363(A6100+R) - SV364(F090+R) - <u>EDIPA</u>	CF TF TF TF	- - - Y
<b>SID EVKAS 1U RNAV (GNSS)</b>			
To SV361 on course 063PM at or above 4200 ft, turn left. To SV362 at or above FL100, turn left. To <u>EVKAS</u> .	SV361(M063.A4200+L) - SV362(F100+L) - <u>EVKAS</u>	CF TF TF	- - Y
<b>SID KESIK 1U RNAV (GNSS)</b>			
To SV361 on course 063PM at or above 4200 ft, turn left. To SV362 at or above FL100. To <u>KESIK</u> .	SV361(M063.A4200+L) - SV362(F100+L) - <u>KESIK</u>	CF TF TF	- - Y
<b>SID LININ 1U RNAV (GNSS)</b>			
To SV361 on course 063PM at or above 4200 ft, turn left. To SV362 at or above FL100, turn right. To <u>LININ</u> .	SV361(M063.A4200+L) - SV362(F100+R) - <u>LININ</u>	CF TF TF	- - Y
<b>SID MOPAC 1U RNAV (GNSS)</b>			
To SV361 on course 063PM at or above 4200 ft, turn left. To IREDO, turn left. To <u>MOPAC</u> .	SV361(M063.A4200+L) - IREDO(L) - <u>MOPAC</u>	CF TF TF	- - Y
<b>SID NEMDO 1U RNAV (GNSS)</b>			
To SV361 on course 063PM at or above 4200 ft, turn left. To IREDO, turn right. To <u>NEMDO</u> .	SV361(M063.A4200+L) - IREDO(R) - <u>NEMDO</u>	CF TF TF	- - Y

TEXTUAL DESCRIPTION	ABBREVIATED DESCRIPTION	Expected Path Terminator Coding	Fly-Over Required
NOTES APPLICABLE TO ALL SID: - RNP1 APPROVAL REQUIRED - REQUIRED GNSS - IAS MAX 250 Kt TO REACH FL100			
<b>SID NINAU 1U RNAV (GNSS)</b>			
To SV361 on course 063PM at or above 4200 ft, turn right. To <u>NINAU</u> .	SV361(M063.A4200+R) - <u>NINAU</u>	CF TF	- Y
<b>SID SISAU 1U RNAV (GNSS)</b>			
To SV361 on course 063PM at or above 4200 ft, turn right. To SV363 at or above 6100 ft. To SV365 at or above FL090. To <u>SISAU</u> .	SV361(M063.A4200+R) - SV363(A6100+L) - SV365(F090+L) - <u>SISAU</u>	CF TF TF TF	- - - Y

**STANDARD DEPARTURE CHART**  
**INSTRUMENT (SID)**  
**Categories A-B-C**

**SÃO PEDRO CESARIA EVORA/Intl - (GVSV)**

**RWY 24**

MOPAC 2H, NEMDO 2H, NINAU 2H, SNT 2H, EDIPA 2H, EVKAS 2H, SISAU 2H

TWR 118.4  
APP  
ACC

TRANSITIONAL ALTITUDE: 7 000

ELEV & ALT IN FEET  
DISTANCE IN NM  
BRG ARE MAGNETIC  
VAR 10°W (2020, 0.18°E yearly)

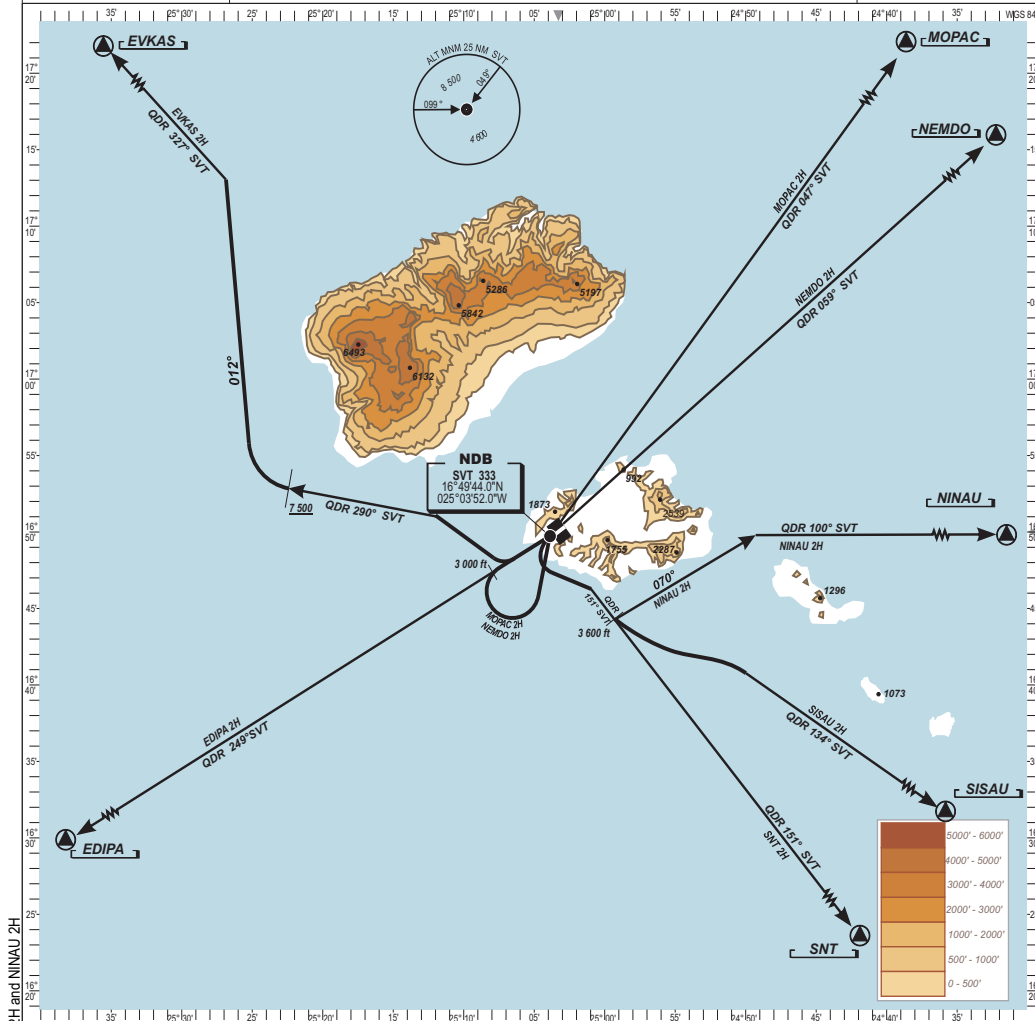

Changed: EVKAS 2H and NINAU 2H

- EDIPA 2H:** After take-off, follow QDR 249° to EDIPA.
- EVKAS 2H:** After take-off, turn right and follow QDR 290° SVT till 7 500 ft then, turn right and follow mag. route 012° to intercept and follow QDR 327° to EVKAS. Do not turn before NDB SVT.
- MOPAC 2H:** Climb on runway heading till passing 3 000 ft, then, turn left to overhead SVT. Follow QDR 047° SVT to MOPAC.
- NEMDO 2H:** Climb on runway heading till passing 3 000 ft, then turn left to overhead SVT. Follow QDR 059° to NEMDO.
- NINAU 2H:** After passing SVT NDB, turn left, maximum bank angle 15° to join and follow QDR 151° SVT until passing 3 600 ft, then, turn left and follow mag route 070° to join and follow QDR 100° SVT to NINAU.
- SISAU 2H:** After passing SVT NDB, turn left, maximum bank angle 15° to join and follow QDR 151° SVT until passing 3 600 ft, then, turn left to join and follow QDR 134° SVT to SISAU (16°21'16"N - 024°20'11"W)
- SNT 2H:** After passing SVT NDB, turn left, maximum bank angle 15° to join and follow QDR 151° SVT to SNT VOR (RDL 333° SNT).





TEXTUAL DESCRIPTION	ABBREVIATED DESCRIPTION	Expected Path Terminator Coding	Fly-Over Required
NOTES APPLICABLE TO ALL SID: - RNP 1 APPROVAL REQUIRED - REQUIRED GNSS - IAS MAX 250 kt TO REACH FL100			
<b>SID DENER IX RNAV (GNSS)</b>			
To SV371 on course 2439M at or above 1500ft, turn left. To <u>DENER</u> .	SV371[M243;A1500+L] -DENER	CF TF	- Y
<b>SID EDIPA IX RNAV (GNSS)</b>			
To SV371 on course 2439M at or above 1500ft, turn right. To <u>EDIPA</u> .	SV371[M243;A1500+R] -EDIPA	CF TF	- Y
<b>SID EVKAS IX RNAV (GNSS)</b>			
To SV371 on course 2439M at or above 1500ft, turn right. To SV372, turn right. To <u>EVKAS</u> .	SV371[M243;A1500+R] -SV372[R]-EVKAS	CF TF TF	- - Y
<b>SID KESIK IX RNAV (GNSS)</b>			
To SV371 on course 2439M at or above 1500ft, turn left. To SV373 at or above 3500 ft, turn left. To SV374 at or above FL080, turn left. To SV375, turn left. To <u>KESIK</u> .	SV371[M243;A1500+L] -SV373[A3500+L]- SV374[F080+L]- SV375[L]-KESIK	CF TF TF TF	- - - Y
<b>SID LININ IX RNAV (GNSS)</b>			
To SV371 on course 2439M at or above 1500ft, turn left. To SV373 at or above 3500 ft, turn left. To SV374 at or above FL080, turn left. To SV375, turn left. To <u>LININ</u> .	SV371[M243;A1500+L] -SV373[A3500+L]- SV374[F080+L]- SV375[L]-LININ	CF TF TF TF	- - - Y
<b>SID MOPAC IX RNAV (GNSS)</b>			
To SV371 on course 2439M at or above 1500ft, turn left. To SV373 at or above 3500 ft, turn left. To SV374 at or above FL080, turn left. To SV375, turn right. To <u>MOPAC</u> .	SV371[M243;A1500+L] -SV373[A3500+L]- SV374[F080+L]- SV375[R]-MOPAC	CF TF TF TF TF	- - - - Y
<b>SID NEMDO IX RNAV (GNSS)</b>			
To SV371 on course 2439M at or above 1500ft, turn left. To SV373 at or above 3500 ft, turn left. To SV374 at or above FL080, turn left. To SV375, turn right. To <u>NEMDO</u> .	SV371[M243;A1500+L] -SV373[A3500+L]- SV374[F080+L]- SV375[R]-NEMDO	CF TF TF TF TF	- - - - Y

TEXTUAL DESCRIPTION	ABBREVIATED DESCRIPTION	Expected Path Terminator Coding	Fly-Over Required
NOTES APPLICABLE TO ALL SID: - RNP 1 APPROVAL REQUIRED - REQUIRED GNSS - IAS MAX 250 kt TO REACH FL100			
<b>SID NINAU IX RNAV (GNSS)</b>			
To SV371 on course 2439M at or above 1500 ft, turn left. To SV373 at or above 3500 ft, turn left. To SV374 at or above FL080. To <u>NINAU</u> .	SV371[M243;A1500+L] -SV373[A3500+L]- SV374[F080+L]- NINAU	CF TF TF	- - Y
<b>SID SISAU IX RNAV (GNSS)</b>			
To SV371 on course 2439M at or above 1500 ft, turn left. To SV373 at or above 3500 ft, turn left. To <u>SISAU</u> .	SV371[M243;A1500+L] -SV373[A3500+L]- SISAU	CF TF TF	- - Y

STANDARD INSTRUMENT  
RNAV(GNSS)  
ARRIVAL CHART  
(STAR)-ICAO

AD ELEV 101 FT

VAR 10° W  
TA 7000 TWR 118.400

SÃO PEDRO / Cesária Évora Intl  
SAO VICENTE  
RWY 06

DENER1Y, EDIPA1Y, EVKAS1Y, NEMDO1Y, NINAU1Y, SISAU1Y, SNT1Y

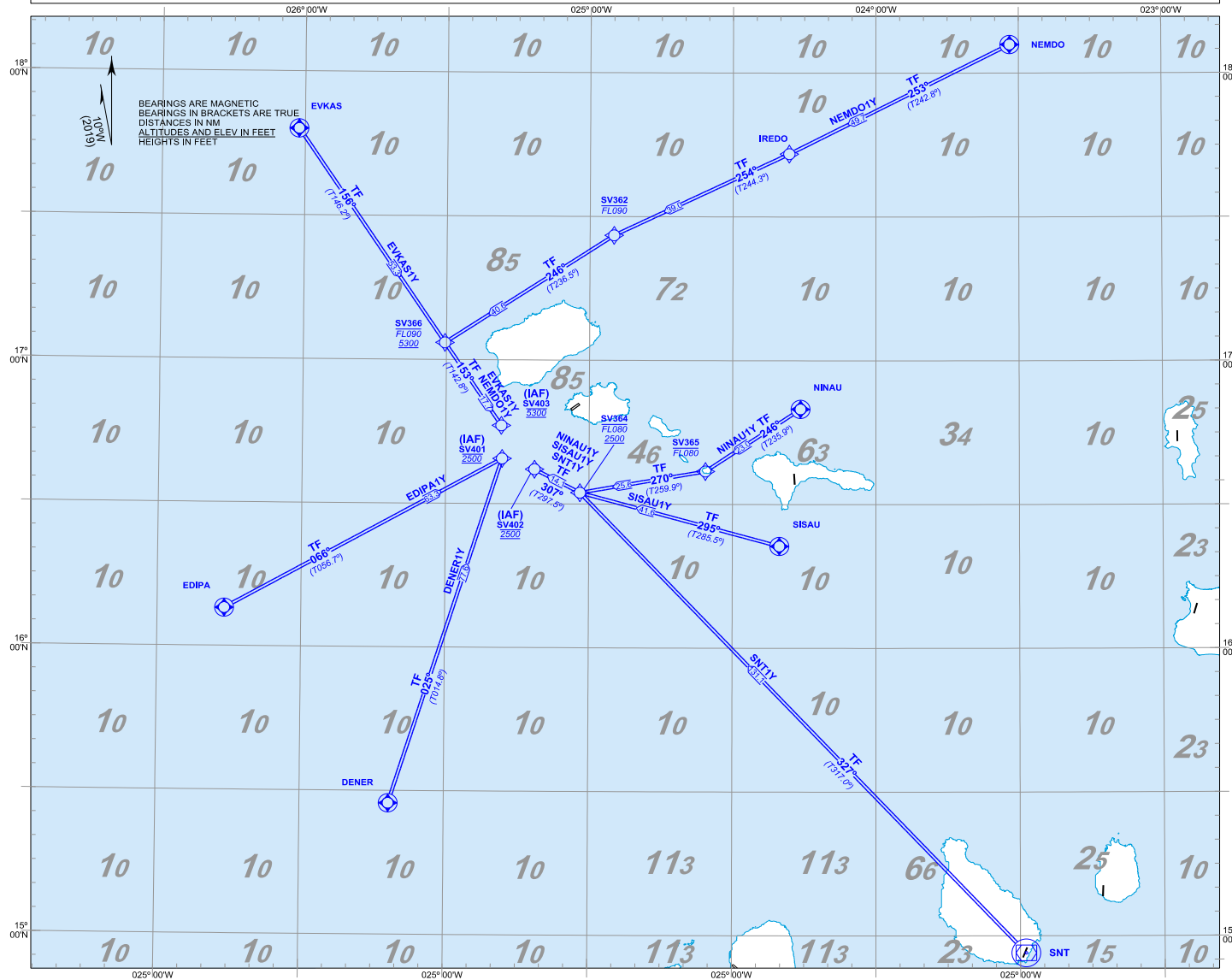

WAYPOINTS:

DENER:	15°27'24.0000"N	025°41'32.0000"W
EDIPA:	16°07'55.0000"N	026°16'00.0000"W
EVKAS:	17°48'03.0000"N	026°01'16.0000"W
IREDO:	17°43'06.0000"N	024°18'12.0000"W
NEMDO:	18°05'57.0000"N	023°31'54.0000"W
NINAU:	16°49'52.0000"N	024°15'47.0000"W
SISAU:	16°21'16.0000"N	024°20'11.0000"W
SV362:	17°26'04.1420"N	024°54'57.1505"W
SV364:	16°32'21.1650"N	025°01'53.1955"W
SV365:	16°36'52.1870"N	024°35'39.2805"W
SV366:	17°03'32.9835"N	025°30'18.1685"W
SV401:	16°42'41.3500"N	025°20'51.8060"W
SV402:	16°38'52.1592"N	025°14'53.4186"W
SV403:	16°49'24.5854"N	025°19'10.9055"W
SNT DVOR/DME:	14°56'20.7400"N	023°28'55.6400"W

RNP1 APPROVAL REQUIRED.

IAS MAX 250 kt to reach FL100 or below

ESCALA 1:1 500 000

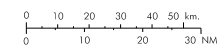

TEXTUAL DESCRIPTION	ABBREVIATED DESCRIPTION	Expected Path Terminator Coding	Fly-Over Required
NOTES APPLICABLE TO ALL STAR - RNP1 APPROVAL REQUIRED - REQUIRED GNSS - IAS MAX 250 kt BELOW FL100			
<b>STAR DENER 1Y RNAV (GNSS)</b>			
DENER, To SV401 (IAF) at 2500 ft.	DENER – SV401(A2500)	IF TF	Y -
<b>STAR EDIPA 1Y RNAV (GNSS)</b>			
EDIPA, To SV401 (IAF) at 2500 ft.	EDIPA – SV401(A2500)	IF TF	Y -
<b>STAR EVKAS 1Y RNAV (GNSS)</b>			
EVKAS, To SV366 at 5300 ft minimum, FLO90 maximum. To SV403 (IAF) at 5300 ft.	EVKAS – SV366(A5300+P090) – SV403(A5300)	IF TF TF	Y - -
<b>STAR NEMDO 1Y RNAV (GNSS)</b>			
NEMDO, To IREDO. To SV362 at or below FLO90, turn left. To SV366 at 5300 ft minimum, FLO90 maximum, turn left. To SV403 at 5300 ft.	NEMDO – IREDO – SV362(P090-A) – SV366(A5300+P090-A) – SV403(A5300)	IF TF TF TF	Y - - -
<b>STAR NINAU 1Y RNAV (GNSS)</b>			
NINAU, To SV365 at or below FLO80, turn right. To SV364 at 2500 ft minimum, FLO80 maximum, turn right. To SV402 at 2500 ft.	NINAU – SV365(P080-R) – SV364(A2500+P080-R) – SV402(A2500)	IF TF TF TF	Y - - -
<b>STAR SISAU 1Y RNAV (GNSS)</b>			
SISAU, To SV364 at 2500 ft minimum, FLO80 maximum, turn right. To SV402 at 2500 ft.	SISAU – SV364(A2500+P080-R) – SV402(A2500)	IF TF TF	Y - -
<b>STAR SNT 1Y RNAV (GNSS)</b>			
SNT, To SV364 at 2500 ft minimum, FLO80 maximum, turn left. To SV402 at 2500 ft.	SNT – SV364(A2500+P080-A) – SV402(A2500)	IF TF TF	Y - -



TEXTUAL DESCRIPTION	ABBREVIATED DESCRIPTION	Expected Path Terminator Coding	Fly-Over Required
NOTES APPLICABLE TO ALL STAR: - RNP 1 APPROVAL REQUIRED - REQUIRED GNSS - IAS MAX 250 kt BELOW FL100			
<b>STAR DENER 1Z RNAV (GNSS)</b>			
DENER. To SV377. To SV374 at 4000 ft minimum, 7000 ft maximum, turn left. To SV501 at 4000 ft.	DENER - SV377 - SV374(A4000-A7000-;L) - SV501(A4000)	IF TF TF TF	Y - - -
<b>STAR EDPA 1Z RNAV (GNSS)</b>			
EDPA. To SV377, turn left. To SV374 at 4000 ft minimum, 7000 ft maximum, turn left. To SV501 at 4000 ft.	EDPA - SV377(A) - SV374(A4000-A7000-;L) - SV501(A4000)	IF TF TF TF	Y - - -
<b>STAR EVKAS 1Z RNAV (GNSS)</b>			
EVKAS. To SV376, turn right. To SV502 at 2500 ft.	EVKAS - SV376 - SV502(A2500)	IF TF TF	Y - -
<b>STAR NEMDO 1Z RNAV (GNSS)</b>			
NEMDO. To SV375. To SV502 at 2500 ft.	NEMDO - SV375 - SV502(A2500)	IF TF TF	Y - -
<b>STAR NINAU 1Z RNAV (GNSS)</b>			
NINAU. To SV374 at 4000 ft minimum, 7000 ft maximum, turn right. To SV501 at 4000 ft.	NINAU - SV374(A4000-A7000-;R) - SV501(A4000)	IF TF TF	Y - -
<b>STAR SISAU 1Z RNAV (GNSS)</b>			
SISAU. To SV374 at 4000 ft minimum, 7000 ft maximum. To SV501 at 4000 ft.	SISAU - SV374(A4000-A7000-;R) - SV501(A4000)	IF TF TF	Y - -
<b>STAR SNT 1Z RNAV (GNSS)</b>			
SNT. To SSAU, turn left. To SV374 at 4000 ft minimum, 7000 ft maximum. To SV501 at 4000 ft.	SNT - SSAU(L) - SV374(A4000-A7000-;R) - SV501(A4000)	IF TF TF TF	Y Y - -

**STANDARD ARRIVAL CHART  
INSTRUMENT (STAR)  
Categories A-B-C**

TWR 118.4  
APP  
ACC

**SÃO PEDRO CESARIA EVORA/Intl - (GVSV)  
RWYs 06 & 24  
LININ,NEMDO 2V,NINAU 2V,  
SISAU 2V,SNT 2V,DENER 2V,EVKAS 2V**

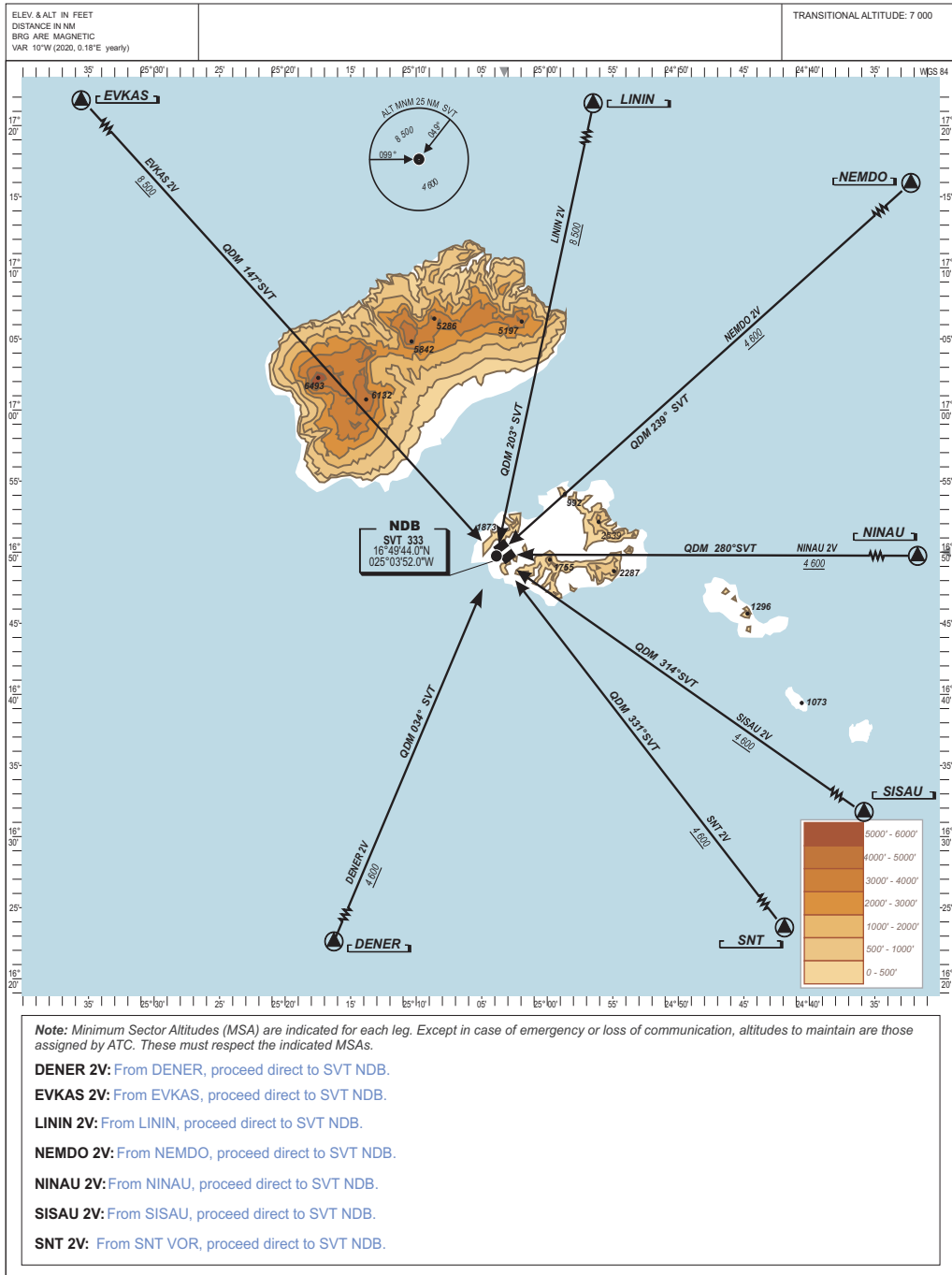

INSTRUMENT APPROACH CHART - ICAO

AD ELEV 101 FT  
VAR 10°W

TWR 118.400

SÃO PEDRO / Cesária Évora Intl  
SÃO VICENTE  
RNAV (GNSS) RWY 06

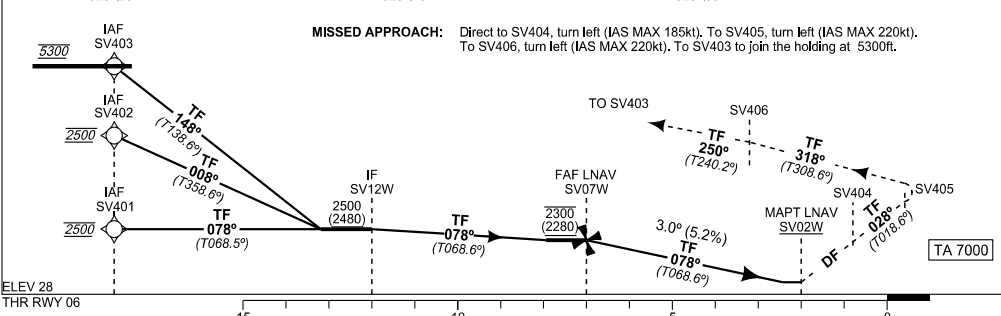
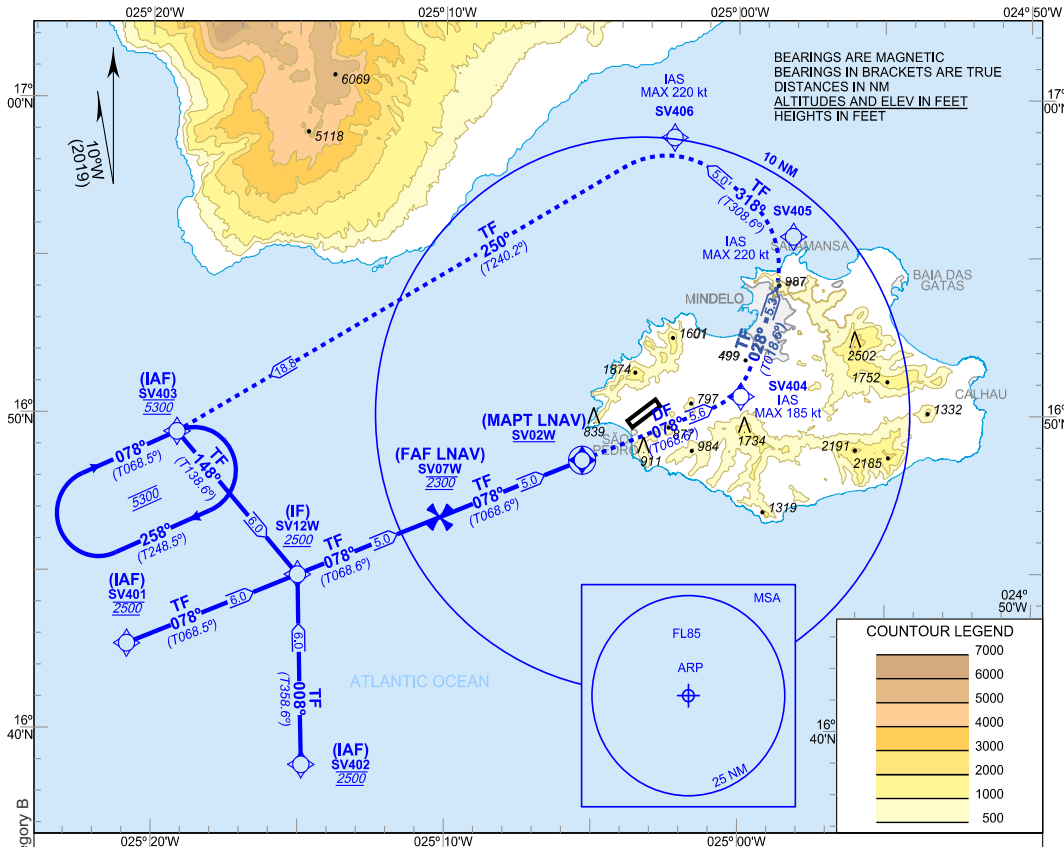

AIRCRAFT CATEGORY	A B C D				AIRCRAFT CATEGORY	A	B	C	D
	OCA (OCH)					OCA (OCH)	OCA (OCH)	OCA (OCH)	OCA (OCH)
LNAV 2.5%	1270 (1250)				LNAV/VNAV 2.5%	1150 (1130)	1160 (1140)	1180 (1160)	1210 (1190)
LNAV 3.0%	1190 (1170)				LNAV/VNAV 3.0%	1030 (1010)	1040 (1020)	1060 (1040)	1100 (1080)
LNAV 4.0%	990 (970)				LNAV/VNAV 4.0%	840 (820)	850 (830)	880 (860)	910 (890)

① TIMING IS NOT AUTHORIZED FOR DEFINING MAPT  
② CIRCLING NOT AUTHORIZED.

RNP APCH REQUIRED  
LNAV/VNAV TEMPERATURE: MINIMUM 5°C  
MAXIMUM 40°C

RW 06	7	6	5	4	3	2	1
ALT (HGT) FNA		1990 (1970)	1670 (1650)	1350 (1330)			
GS	kt	80	100	120	140	160	180
FAF-MAPT: ①	mins						
ROD: 5.2 %	ft/min	424	531	637	743	849	955



PROCEDURE DESCRIPTION/ APPROACH FROM SV401			
TEXTUAL DESCRIPTION	ABBREVIATED DESCRIPTION	EXPECTED PATH TERMINATOR CODING	FLY-OVER REQUIRED
SV401 at 2500 ft.	SV401[A2500]	IF	-
To SV12W at 2500 ft.	SV12W[A2500]	TF	-
To SV07W at 2300 ft.	SV07W[A2300]	TF	-
To SV02W at or above 714 ft.	SV02W[A714+]	TF	Y
MISSED APPROACH			
Direct to SV404, turn left, maximum speed 185kt.	→SV404[L;K185-]	DF	-
To SV405, turn left, maximum speed 220kt.	SV405[L,K220-]	TF	-
To SV406, turn left, maximum speed 220kt.	SV406[L,K220-]	TF	-
To SV403 {HM;RT068.5;1min} at 5300 ft.	SV403[HM;R;T068.5;1min;A5300]	TF	-
PROCEDURE DESCRIPTION/ APPROACH FROM SV402			
TEXTUAL DESCRIPTION	ABBREVIATED DESCRIPTION	EXPECTED PATH TERMINATOR CODING	FLY-OVER REQUIRED
SV402 at 2500 ft.	SV402[A2500]	IF	-
To SV12W at 2500 ft, turn right.	SV12W[A2500;R]	TF	-
To SV07W at 2300 ft.	SV07W[A2300]	TF	-
To SV02W at or above 714 ft.	SV02W[A714+]	TF	Y
MISSED APPROACH			
Direct to SV404, turn left, maximum speed 185kt.	→SV404[L;K185-]	DF	-
To SV405, turn left, maximum speed 220kt.	SV405[L,K220-]	TF	-
To SV406, turn left, maximum speed 220kt.	SV406[L,K220-]	TF	-
To SV403 {HM;R;T068.5;1min} at 5300 ft.	SV403[HM;R;T068.5;1min;A5300]	TF	-
PROCEDURE DESCRIPTION/ APPROACH FROM SV403			
TEXTUAL DESCRIPTION	ABBREVIATED DESCRIPTION	EXPECTED PATH TERMINATOR CODING	FLY-OVER REQUIRED
SV403 at 5300 ft.	SV403[A5300]	IF	-
To SV12W at or above 2500 ft, turn left.	SV12W[A2500+;L]	TF	-
To SV07W at 2300 ft.	SV07W[A2300]	TF	-
To SV02W at or above 714 ft.	SV02W[A714+]	TF	Y
MISSED APPROACH			
Direct to SV404, turn left, maximum speed 185kt.	→SV404[L;K185-]	DF	-
To SV405, turn left, maximum speed 220kt.	SV405[L,K220-]	TF	-
To SV406, turn left, maximum speed 220kt.	SV406[L,K220-]	TF	-
To SV403 {HM;R;T068.5;1min} at 5300 ft.	SV403[HM;R;T068.5;1min;A5300]	TF	-

INSTRUMENT APPROACH CHART - ICAO

AD ELEV 101 FT  
VAR 10°W

TWR 118.400

SÃO PEDRO / Cesária Évora Intl  
SAO VICENTE  
RNAV (GNSS) RWY 24

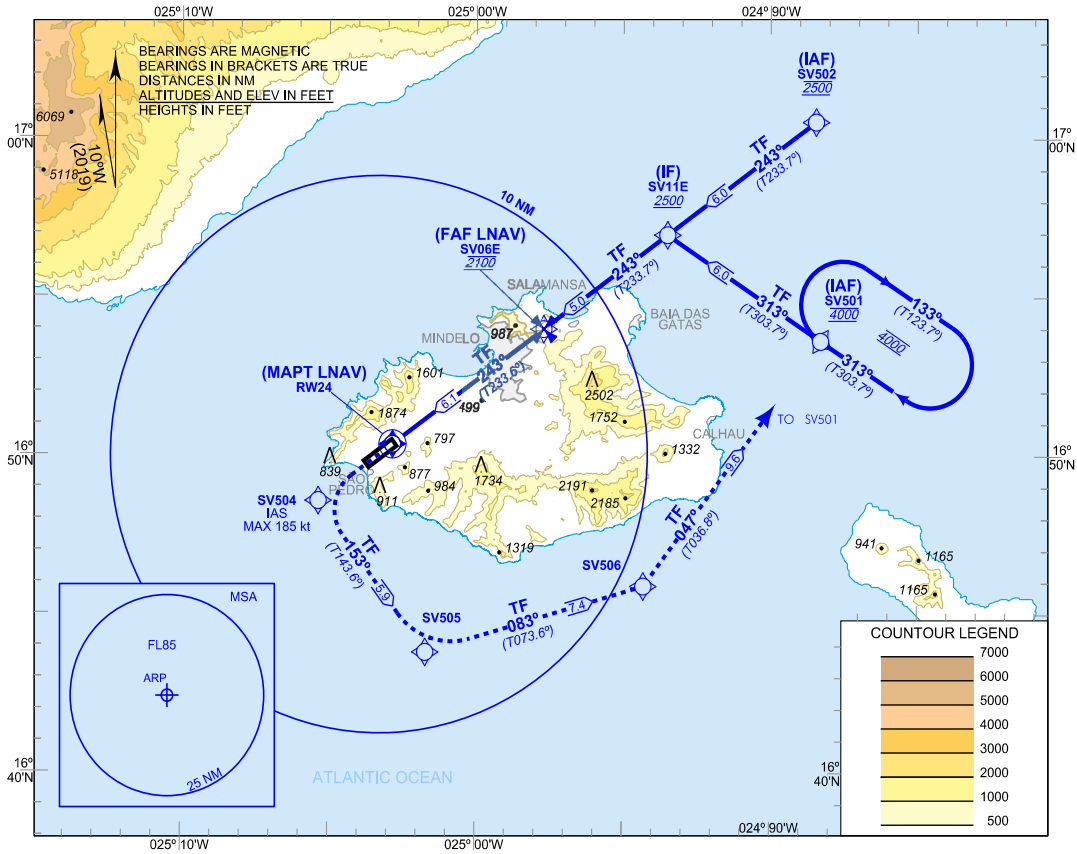

MISSED APPROACH: Climb up direct to SV504. Turn left (IAS MAX 185 kt) to SV505. Turn left to SV506. Turn left to SV501 to join the holding at 4000ft.

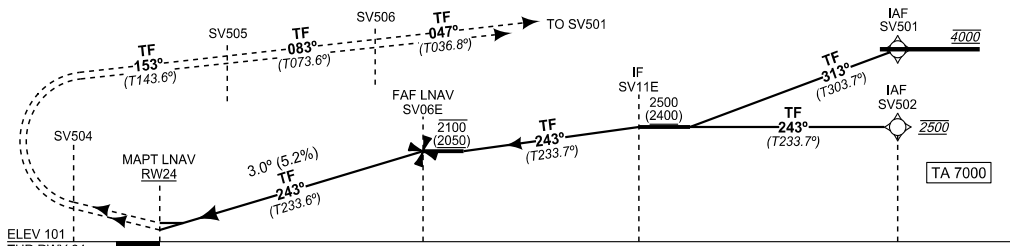

AIRCRAFT CATEGORY	A	B	C	D				
LNAV 2.5%	OCA (OCH)							
LNAV/VNAV 2.5%	1290 (1190)							
CIRCLING ②	1290 (1190)							
① TIMING IS NOT AUTHORIZED FOR DEFINING MAPT ② CIRCLING NOT AUTHORIZED  RNP APCH REQUIRED LNAV/VNAV TEMPERATURE: MINIMUM 5°C MAXIMUM 40°C	AD		6	5	4	3	2	1
	ALT (HGT) FNA		2070 (1970)	1750 (1650)	1430 (1330)			
	GS	kt	80	100	120	140	160	180
	FAF-MAPT: ①	mins						
ROD: 5.2 %	ft/min	424	531	637	743	849	955	

PROCEDURE DESCRIPTION / APPROACH FROM SV501			
TEXTUAL DESCRIPTION	ABBREVIATED DESCRIPTION	EXPECTED PATH TERMINATOR CODING	FLY-OVER REQUIRED
SV501 at 4000 ft.	SV501[A4000]	IF	-
To SV11E at or above 2500 ft, turn left.	SV11E[A2500+;L]	TF	-
To SV06E at 2100 ft.	SV06E[A2100]	TF	-
To <u>RW24</u> at or above 154 ft.	<u>RW24</u> [A154+]	TF	Y
MISSED APPROACH			
Direct to SV504, turn left, maximum speed 185kt.	→SV504[L;K185-]	DF	-
To SV505, turn left.	SV505[L]	TF	-
To SV506, turn left	SV506[L]	TF	-
To SV501 {HM;R;T303.7;1min} at 4000 ft.	SV501 [HM;R; T303.7;1min;A4000]	TF	-
PROCEDURE DESCRIPTION / APPROACH FROM SV502			
TEXTUAL DESCRIPTION	ABBREVIATED DESCRIPTION	EXPECTED PATH TERMINATOR CODING	FLY-OVER REQUIRED
SV502 at 2500 ft.	SV502[A2500]	IF	-
To SV11E at 2500 ft.	SV11E[A2500]	TF	-
To SV06E at 2100 ft.	SV06E[A2100]	TF	-
To <u>RW24</u> at or above 154 ft.	<u>RW24</u> [A154+]	TF	Y
MISSED APPROACH			
Direct to SV504, turn left, maximum speed 185kt.	→SV504[L;K185-]	DF	-
To SV505, turn left.	SV505[L]	TF	-
To SV506, turn left	SV506[L]	TF	-
To SV501 {HM;R;T303.7;1min} at 4000 ft.	SV501 [HM;R; T303.7;1min;A4000]	TF	-



**INSTRUMENT APPROACH CHART - ICAO** **AD ELEV 101 FT** **VAR 10°W** **TWR 118.400** **SÃO PEDRO / Cesária Évora Intl SÃO VICENTE** **NDB/LOC RWY 06**

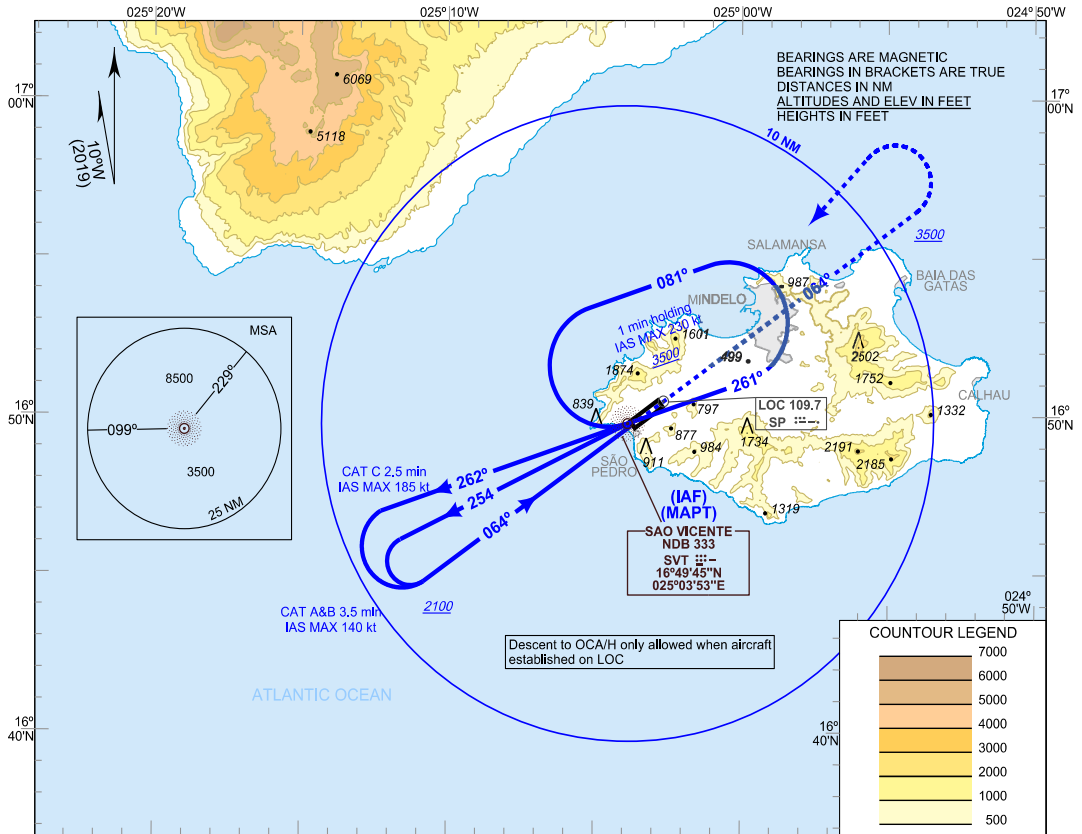

**MISSED APPROACH:** Climb on 064° SVT to 3500. Turn left direct to SVT NDB, enter HLD or as instructed.

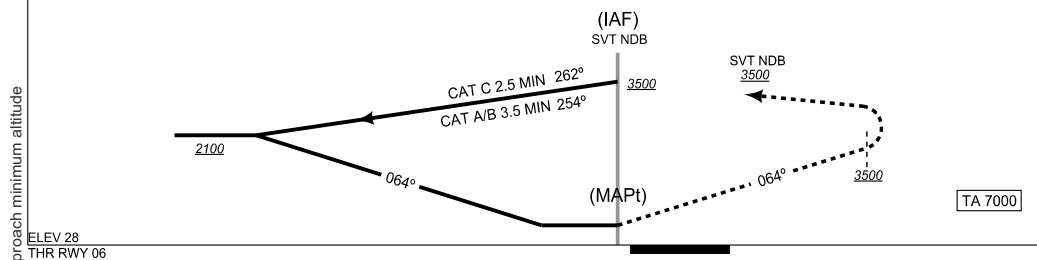

Changed: Missed approach minimum altitude

AIRCRAFT CATEGORY	A	B	C	D			
STA 2.5%	OCA 1430 (HAT 1410)						
CIRCLING	No circling allowed						
YYY DME		5	4	3	2	1	
ALT (HGT) FNA							
GS	kt	80	100	120	140	160	180
FAF-THR:	min:s						
FAF-MAPT:	min:s						
ROD:	ft/min						

**VISUAL APPROACH  
CHART**

16° 50'01"N  
025° 03'16"W AD ELEV 101 ft **TWR 118.4**

**SAO PEDRO  
AEROPORTO INTL CESARIA EVORA**

